

Series 360

Granville-Phillips® Series 360 Stabil-Ion® Vacuum Measurement Controller



Instruction Manual

Instruction manual part number 360119

Revision A - September 2014

Series 360

Granville-Phillips® Series 360 Stabil-Ion® Vacuum Measurement Controller

This Instruction Manual is for use with all Granville-Phillips Series 360 Vacuum Measurement Controllers.



For Customer Service or Technical Support 24 hours per day,
7 days per week, every day of the year including holidays:
Phone: +1-800-227-8766 or +1-303-652-4691

MKS, Granville-Phillips Division

6450 Dry Creek Parkway
Longmont, CO 80503 USA

Phone: 1-303-652-4691 or 1-800-776-6543

FAX: 1-303-652-2844

Email: gp-csr@mksinst.com

Corporate Office

MKS Instruments, Inc.

2 Tech Drive, Suite 201
Andover, MA 01810 USA

Phone: 1-978-645-5500

www.mksinst.com

Instruction Manual

© 2014 MKS Instruments, Inc. All rights reserved.
Granville-Phillips®, Stabil-Ion®, and Convector® are registered trademarks of MKS Instruments, Inc. All other trademarks and registered trademarks are the properties of their respective owners.

Granville-Phillips® Series 360 Stabil-Ion® Vacuum Measurement Controller

Catalog numbers for Series 360 Stabil-Ion Vacuum Measurement Controller

Left Mount, side-by-side with Power Supply: 360501 - # # # - # #

Half-Rack Mount, remote Power Supply: 360502 - # # # - # #

Interface Option:

- None
- RS-232
- RS-485
- IEEE-488

- 0
- A
- B
- C

Gauge Options:

- None
- Dual Convectron

- 0
- 1

Setpoint Options:

- None
- 2 Setpoints for Stabil-Ion Gauge
- 6 Setpoint Relays, 2 per channel

- 0
- A
- B

Display Options - Measurement Units:

- Torr
- mbar
- Pascal

- T
- M
- P

Power Cord Options:

- North America and Japan 115 V
- North America 240 V
- Universal Europe 220 V
- United Kingdom 240 V

- 1
- 2
- 3
- 4

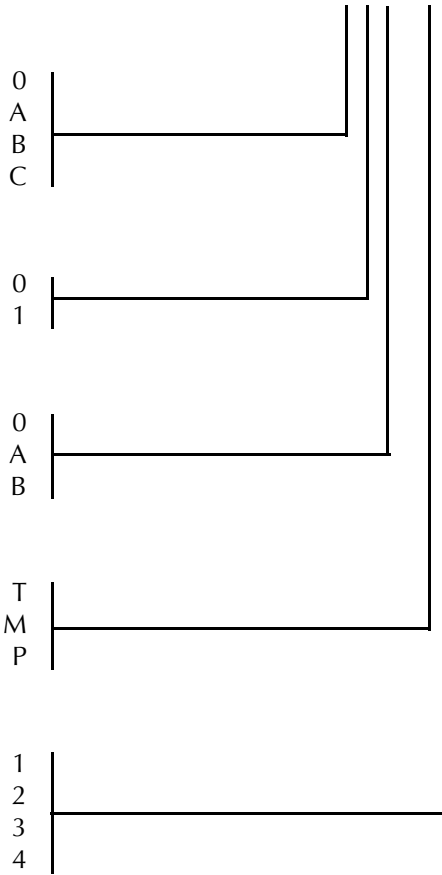

Safety	1-v
Chapter 1 System Components	1-1
Chapter 2 Initial Setup Procedures	2-1
2.1 Control Unit Setup	2-1
2.1.1 Top Cover Removal	2-2
2.1.2 Pressure Units Setup	2-3
2.1.3 Pressure Display Rate of Update	2-4
2.1.4 Process Control Setup	2-5
2.1.4.1 Ion Gauge Assignment for Process Control	2-7
2.1.4.2 Relay Polarity Setting	2-8
2.1.4.3 Process Control Tips	2-9
2.1.5 RS-232 Computer Interface Setup	2-9
2.1.5.1 Selecting the Byte Format	2-10
2.1.5.1.1 Character Framing	2-10
2.1.5.1.2 Talk-Only Mode	2-11
2.1.5.2 Handshaking	2-11
2.1.6 RS-485 Computer Interface Setup	2-12
2.1.6.1 RS-485 Address	2-13
2.1.6.2 Response Delay for the RS-485 Interface	2-13
2.1.6.3 Selecting the Byte Format for RS-485 Communications	2-13
2.1.6.3.1 Baud Rate	2-13
2.1.6.3.2 Character Framing for the RS-485 Computer Interface	2-14
2.1.7 IEEE 488 Computer Interface Setup	2-15
2.1.7.1 Selecting the Interface Bus Address	2-15
2.1.7.2 Talk-Only Mode	2-15
2.1.7.3 SRQ Mode	2-16
2.1.8 Degas Timer	2-16
2.1.9 Replacing Control Unit Cover	2-17
2.2 Power Supply Setup	2-17
Chapter 3 Installation	3-1
3.1 Gauge Installation Tips	3-1
3.1.1 EMC Compliance	3-1
3.1.2 Cable Installation Statement	3-1
3.1.3 Environmental Conditions	3-2
3.2 Stabil-Ion Gauge Installation	3-2
3.3 Convectron Gauge Installation	3-3
3.3.1 Compression Mount/Quick Connect	3-4
3.3.2 1/8 NPT Mount	3-4
3.3.3 VCR [®] /VCO [®] Mount	3-4
3.3.4 NW16KF Flange Mount	3-4
3.3.5 ConFlat Flange Mount	3-4
3.4 Installing the Control Unit and Power Supply	3-5
3.4.1 Grounding the System	3-5
3.5 Connecting Analog Outputs	3-7
3.5.1 Stabil-Ion Gauge Analog Output Signal	3-7
3.5.2 Convectron Gauge Analog Output Signal	3-7
3.6 Connecting Process Control Relays	3-8

3.7	Connecting Stabil-Ion Remote Control	3-9
3.7.1	Definition of Input States	3-10
3.7.2	Using the Remote Inputs	3-11
3.7.3	Using the Remote Outputs	3-13
3.8	Connecting the RS-232 Computer Interface	3-13
3.9	Connecting the RS-485 Computer Interface	3-16
3.10	Connecting the IEEE 488 Computer Interface	3-18
3.11	Connecting the Gauge Cables	3-18
3.12	Connecting the Power Cables	3-21
Chapter 4	Preparing the Stabil-Ion System for Operation	4-1
4.1	Preparing for Pressure Measurement with the Stabil-Ion Gauge	4-1
4.1.1	Alternate ON/OFF Gauge Control	4-3
4.1.2	Gas Scale Factor Adjustment	4-4
4.1.3	Overpressure Shutdown	4-5
4.2	Degassing the Stabil-Ion Gauge	4-5
4.2.1	Pressure Indication During Degas	4-7
4.2.2	Degas Timer	4-7
4.2.3	Degas Limiter	4-7
4.2.4	Gauge Bakeout	4-7
4.3	Alternate Cathode Operation	4-7
4.4	Stabil-Ion Gauge Calibration Memory	4-8
4.4.1	Memory Modules for Stabil-Ion Gauge	4-8
4.4.2	Using a Memory Module for IG1 or IG2	4-8
4.5	Stabil-Ion Gauge Analog Output Signal	4-10
4.6	Preparing for Convectron Gauge Operation	4-11
4.6.1	Understanding Pressure Measurement in Gases other than Nitrogen (or Air)	4-12
4.6.2	Examples	4-13
4.7	Ionization Gauge Auto Turn On/Off	4-21
4.7.1	To Set the On/Off Pressure for IG1/IG2	4-21
4.8	Adjustment of Convectron Gauge Zero and Atmospheric Pressure Indications	4-22
4.9	Convectron Gauge Analog Output Signal	4-23
4.10	Preparing for Process Control Operation	4-24
4.10.1	Setpoint Display and Adjustment	4-24
4.10.2	To Display a Setpoint	4-24
4.10.3	To Modify a Setpoint	4-25
4.11	Preparing for Use of the RS-232 Computer Interface	4-25
4.11.1	RS-232 Command Syntax	4-26
4.12	Preparing for use of the RS-485 Computer Interface	4-29
4.12.1	RS-485 Command Syntax	4-30
4.13	Preparing for Use of the IEEE 488 Computer Interface	4-32
4.13.1	IEEE 488 Command Syntax	4-32
Chapter 5	Operation of a Stabil-Ion System	5-1
Chapter 6	Service and Maintenance	6-1
6.1	Service Guidelines	6-1
6.2	Damage Requiring Service	6-2
6.3	Fault Relay	6-4
6.4	Overpressure Shutdown	6-5
6.5	Electrometer Minimum Calibration Adjustment	6-6
6.6	Flashing Degas Light	6-6
6.7	Troubleshooting the Convectron Gauge Module	6-7
6.8	Convectron Gauge Test Procedure	6-8
6.9	Cleaning Contaminated Convectron Gauges	6-8

6.10	Process Control Troubleshooting	6-9
6.11	RS-232 Troubleshooting	6-9
6.12	RS-485 Troubleshooting	6-10
6.13	IEEE 488 Troubleshooting	6-10
6.14	Field Installation of Modules	6-11
6.15	Troubleshooting Flow Charts	6-12
6.16	Service Form	6-15
Index	Index-1

Safety Instructions

START BY READING THESE IMPORTANT SAFETY INSTRUCTIONS AND NOTES collected here for your convenience and repeated with additional information at appropriate points in these instructions.

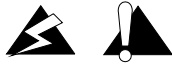

These safety alert symbols in this manual or on the Product rear panel, mean caution - personal safety, property damage or danger from electric shock. Read these instructions carefully.

In these instructions the word “product” refers to the 360 Stabil-Ion Vacuum Measurement System and all of its approved parts and accessories.

NOTE: These instructions do not and cannot provide for every contingency that may arise in connection with the installation, operation, or maintenance of this product. If you require further assistance, contact MKS, Granville-Phillips Division at the address on the title page of this manual.

This product has been designed and tested to offer reasonably safe service provided it is installed, operated, and serviced in strict accordance with these safety instructions.



Failure to comply with these instructions may result in serious personal injury, including death, or property damage.

These safety precautions must be observed during all phases of operation, installation, and service of this product. Failure to comply with these precautions or with specific warnings elsewhere in this manual violates safety standards of design, manufacture, and intended use of the instrument. MKS Instruments, Inc. disclaims all liability for the customer's failure to comply with these requirements.



The service and repair information in this manual is for the use of Qualified Service Personnel. To avoid shock, do not perform any procedures in this manual or perform any servicing on this product unless you are qualified to do so.

- *Read Instructions* – Read all safety and operating instructions before operating the product.
- *Retain Instructions* – Retain the Safety and Operating Instructions for future reference.
- *Heed Warnings* – Adhere to all warnings on the product and in the operating instructions.
- *Follow Instructions* – Follow all operating and maintenance instructions.
- *Accessories* – *Do not* use accessories not recommended in this manual as they may be hazardous.



To reduce the risk of fire or electric shock, do not expose this product to rain or moisture.



Objects and Liquid Entry - Never push objects of any kind into this product through openings as they may touch dangerous voltage points or short out parts that could result in a fire or electric shock. Be careful not to spill liquid of any kind onto the products.

Do not substitute parts or modify instrument.



Because of the danger of introducing additional hazards, do not install substitute parts or perform any unauthorized modification to the product. Return the product to a service facility designated by Granville-Phillips for service and repair to ensure that safety features are maintained. Do not use this product if it has unauthorized modifications.

Damage Requiring Service

Disconnect the product from the wall outlet and all power sources and refer servicing to Qualified Service Personnel under the following conditions:

- a. When any cable or plug is damaged.
- b. If any liquid has been spilled onto, or objects have fallen into, the product.
- c. If the product has been exposed to rain or water.
- d. If the product does not operate normally even if you follow the operating instructions. Adjust only those controls that are covered by the operation instructions. Improper adjustment of other controls may result in damage and will often require extensive work by a qualified technician to restore the product to its normal operation.
- e. If the product has been dropped or the enclosure has been damaged.
- f. When the product exhibits a distinct change in performance. This indicates a need for service.



Replacement Parts - When replacement parts are required, be certain to use the replacement parts that are specified by Granville-Phillips, or that have the same characteristics as the original parts. Unauthorized substitutions may result in fire, electric shock or other hazards.



Safety Check - Upon completion of any service or repairs to this product, ask the Qualified Service Person to perform safety checks to determine that the product is in safe operating order.



Finite Lifetime - After ten years of normal use or even non-use, the electrical insulation in this product may become less effective at preventing electrical shock. Under certain environmental conditions which are beyond the manufacturer's control, some insulation material may deteriorate sooner. Therefore, periodically inspect all electrical insulation for cracks, crazing, or other signs of deterioration. Do not use if the electrical insulation has become unsafe.



Be aware that when high voltage is present in any vacuum system, a life threatening electrical shock hazard may exist unless all exposed conductors are maintained at earth ground.

This hazard is not peculiar to this product.



Be aware that an electrical discharge through a gas may couple dangerous high voltage directly to an ungrounded conductor almost as effectively as would a copper wire connection. A person may be seriously injured or even killed by merely touching an exposed ungrounded conductor at high potential.

This hazard is not unique to this product.

Proper Grounding:

All components of a vacuum system used with this or any similar high voltage product must be maintained at earth ground for safe operation. The power cord of this product shall be connected only to a properly grounded outlet. Be aware, however, that grounding this product does not guarantee that other components of the vacuum system are maintained at earth ground.



Complying with the usual warning to connect the power cable only to a properly grounded outlet is necessary but not sufficient for safe operation of a vacuum system with this or any similar high voltage producing product.

Verify that the vacuum port to which the Stabil-Ion Gauge is mounted is electrically grounded. It is essential for personnel safety as well as proper operation that the envelope of the gauge be connected to a facility ground. Use a ground lug on a flange bolt if necessary.



All conductors in, on, or around the vacuum system that are exposed to potential high voltage electrical discharges must either be shielded at all times to protect personnel or must be connected to earth ground at all times.



Danger, High Voltage – The high voltages present within the Power Supply are capable of causing injury or death. To avoid electric shock, wait 3 minutes after power is removed before touching any component within the Power Supply. This will permit charged capacitors to discharge.



Danger, high voltage – 180V is present in the Power Supply, on the cable, and at the ion gauge when the gauge is turned on. Voltages as high as 850V peak are present during degas.



Do not touch the Stabil-Ion Gauge during degas operation if the Guard has been removed. Serious burns can occur.



Install suitable devices that will limit the pressure to the level that the vacuum system can safely withstand. In addition, install suitable pressure relief valves or rupture disks that will release pressure at a level considerably below the pressure that the system can safely withstand.

Suppliers of pressure relief valves and pressure relief disks are listed in the *Thomas Register* under “Valves, Relief”, and “Discs, Rupture”.

Confirm that these safety devices are properly installed before installing the product. In addition, check that (1) the proper gas cylinders are installed, (2) gas cylinder valve positions are correct on manual systems, and (3) the automation is correct on automated gas delivery systems.

Vacuum gauges with compression fittings may be forcefully ejected if the vacuum system is pressurized.

 **Do not operate in an explosive atmosphere.**
Do not operate the product in the presence of flammable gases or fumes.
Operation of any electrical instrument in such an environment constitutes a definite safety hazard.

Do not use the product to measure the pressure of explosive or combustible gases or gas mixtures. The sensor wire of the Convector Gauge normally operates at only 125 °C, but it is possible that Controller malfunction can raise the sensor temperature above the ignition temperature of combustible mixtures.

Danger of explosion or inadvertent venting to atmosphere exists on all vacuum systems which incorporate gas sources or involve processes capable of pressurizing the system above safe limits.

 **Warning - If used improperly, Convector Gauges can supply misleading pressure indications that can result in dangerous overpressure conditions within the system. For use with gases other than air or N₂, consult the gas type correction charts in Section 4.6.1 on page 4-12 or use a Memory Module programmed with data for the specific gas being used.**

 **Using the N₂ calibration to pressurize a vacuum system above about 1 Torr with certain other gases can cause dangerously high pressures which may cause explosion of the system. See Section 4.6.1 on page 4-12 before using with other gases.**

 **Caution: If the overpressure shutdown point is increased from the factory settings, an excess pressure rise may go undetected—resulting in possible gauge and/or vacuum system damage. Consult the factory if in doubt.**

 **It is the installer's responsibility to ensure that the automatic signals provided by the product are always used in a safe manner. Carefully check the system programming before switching to automatic operation.**

 **Where an equipment malfunction could cause a hazardous situation, always provide for fail-safe operation. As an example, in an automatic backfill operation where a malfunction might cause high internal pressures, provide an appropriate pressure relief device.**

 **Do not disconnect the ionization gauge cable from either the gauge tube or controller when the ion gauge is on. The connectors are not rated to break the currents and voltages delivered to the ion gauge.**

 **Operation of the product with line voltage other than that selected by the proper power supply switches can cause damage to the instrument and injury to personnel.**

 **The fumes from solvents such as trichloroethylene, perchloroethylene, toluene, and acetone can be dangerous to health if inhaled. Use only in well ventilated areas exhausted to the outdoors. Acetone and toluene are highly flammable and should not be used near an open flame or energized electrical equipment.**

Certification

MKS Instruments, Inc. certifies that this product met its published specifications at the time of shipment from the factory. MKS further certifies that its calibration measurements are traceable to the National Institute of Standards and Technology to the extent allowed by the Institute's calibration facility. See the CE Declaration of Conformity inside the envelope for CE tests performed.

Extended Warranty

MKS Instruments, Inc. provides an extended warranty period to five (5) years from the date of shipment for the Granville-Phillips Series 360 Controllers. The MKS General Terms and Conditions of Sale provide complete and exclusive warranty for MKS, Granville-Phillips Division products. This document is located on our website at www.mkdinst.com, or may be obtained by contacting an MKS, Granville-Phillips Division Customer Service Representative.

Service Guidelines

Some minor problems are readily corrected on site. If the product requires service, please contact our Customer Service Department at 1-303-652-4400 for troubleshooting help over the phone. If the product must be returned for service, request a Return Materials Authorization (RMA) from Granville-Phillips. See Service Guidelines, in Section 6.1. Do not return products without first obtaining an RMA.

Shipping damage on returned products as a result of inadequate packaging is the Buyer's responsibility.

When returning equipment to Granville-Phillips, please use the original packing material whenever possible. Otherwise, contact your shipper or Granville-Phillips for safe packaging guidelines. Circuit boards and modules separated from the controller chassis must be handled using proper anti-static protection methods and must be packaged in anti-static packaging. Granville-Phillips will supply return packaging materials at no charge upon request.

FCC Verification

This equipment has been tested and found to comply with the limits for a Class A digital device, pursuant to Part 15 of the FCC Rules. These limits are designed to provide reasonable protection against harmful interference when the equipment is operated in a commercial environment. This equipment generates, uses, and can radiate radio frequency energy and, if not installed and used in accordance with this instruction manual, may cause harmful interference to radio communications. However, there is no guarantee that interference will not occur in a particular installation. Operation of this equipment in a residential area is likely to cause harmful interference in which case the user will be required to correct the interference at his own expense. If this equipment does cause harmful interference to radio or television reception, which can be determined by turning the equipment off and on, the user is encouraged to try to correct the interference by one or more of the following measures:

- Reorient or relocate the receiving antenna.
- Increase the separation between the equipment and the receiver.
- Connect the equipment into an outlet on a circuit different from that to which the receiver is connected.
- Consult the dealer or an experienced radio or television technician for help.

UL Listed

This product, when labeled, is Listed to UL 3101 Standard for Safety, Laboratory Equipment by Underwriters Laboratories Inc. (UL).

NOTES

System Components

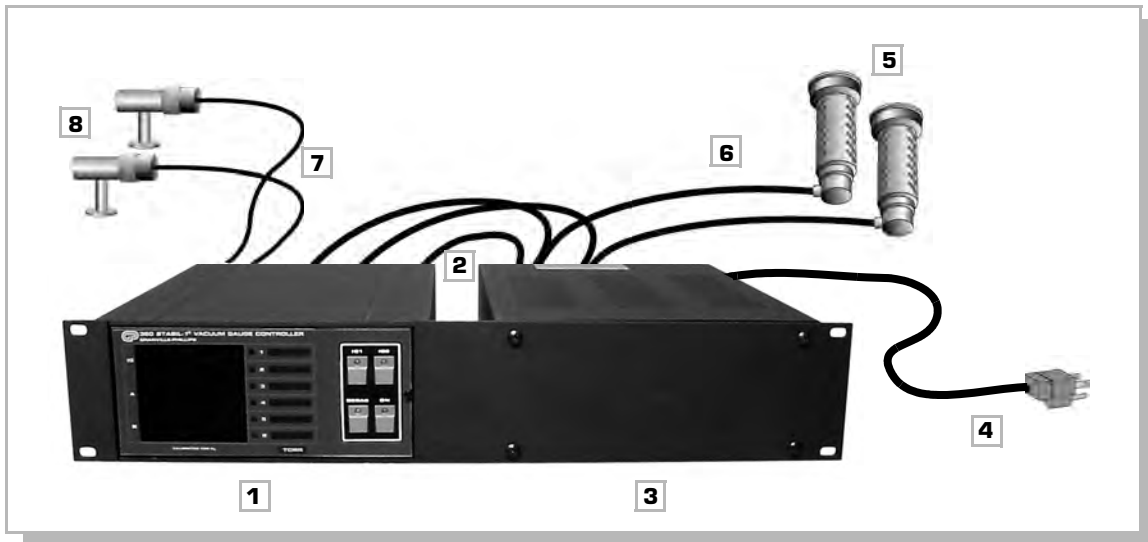

Figure 1-1 Stabil-Ion Vacuum Measuring System.

- | | |
|----------------------------|--------------------------------------|
| 1. Stabil-Ion Control Unit | 5. Stabil-Ion Gauges |
| 2. Interconnect cable | 6. Stabil-Ion cables |
| 3. Stabil-Ion Power Supply | 7. Dual Convector [®] cable |
| 4. Power cable | 8. Convector Gauges |

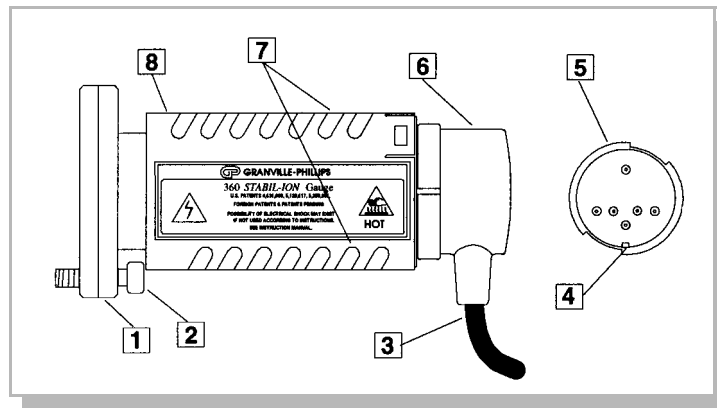

Figure 1-2 Stabil-Ion Gauge.

- | | |
|-------------------------------------|----------------------|
| 1. Stabil-Ion Gauge mounting flange | 5. Pin guard |
| 2. Mounting bolt | 6. Connector shell |
| 3. Cable | 7. Ventilation slots |
| 4. Connector locating pin | 8. Guard |

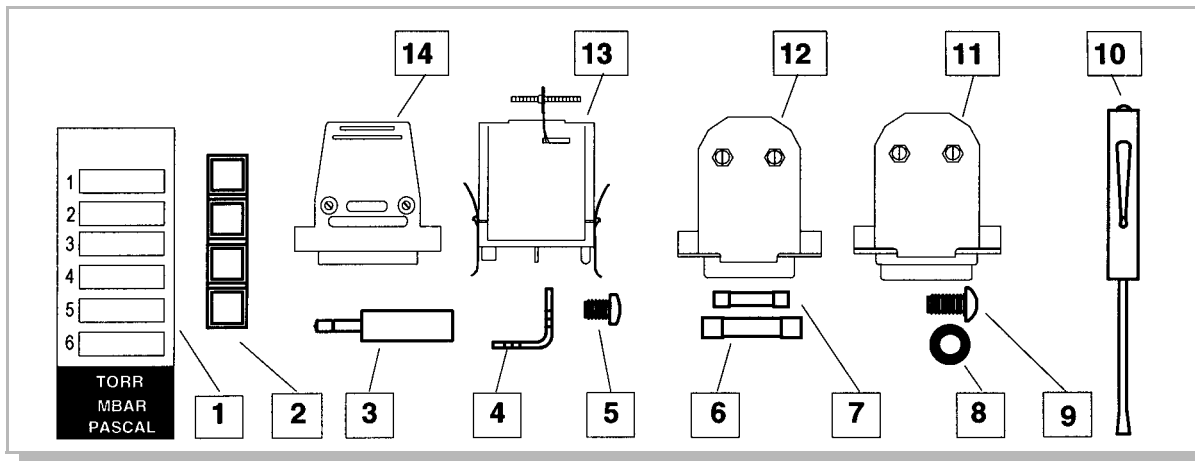

Figure 1-3 Mounting and Installing Hardware.

- | | |
|----------------------------------|--------------------------------------|
| 1. Process Control label | 8. Washer (4 ea.) |
| 2. Rubber stick-on feet | 9. Screw 10-32 x .50 in. (4 ea.) |
| 3. Connector, 1/8 in. phone | 10. Screwdriver |
| 4. Mounting Bracket (4 ea.) | 11. Connector, DA-26P, remote input |
| 5. Screw 10-32 x .31 in. (4 ea.) | 12. Connector, DA-15S, remote output |
| 6. Fuses: 3.0 amp, 2.0 amp | 13. Connector, process control |
| 7. Fuses: 1.6 amp, 1.0 amp | 14. Connector, DB-25S, RS-232 |

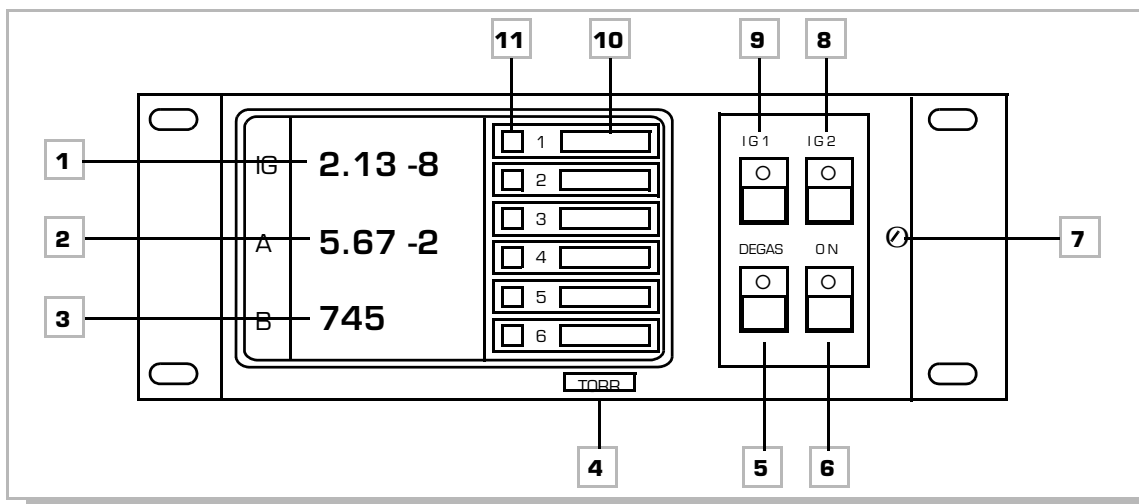

Figure 1-4 Stabil-Ion Vacuum Gauge Control Unit Front Panel.

- | | |
|---|--|
| 1. Stabil-Ion display, for gauge 1 or 2 | 7. Front door closure |
| 2. Convectron Gauge A display | 8. Stabil-Ion Gauge 2 power switch |
| 3. Convectron Gauge B display | 9. Stabil-Ion Gauge 1 power switch |
| 4. Unit of measure label, Torr, mbar or Pascal, user selectable | 10. Process Control channel labels |
| 5. Degas power switch | 11. Process Control channel indicator lights |
| 6. Controller power switch | |

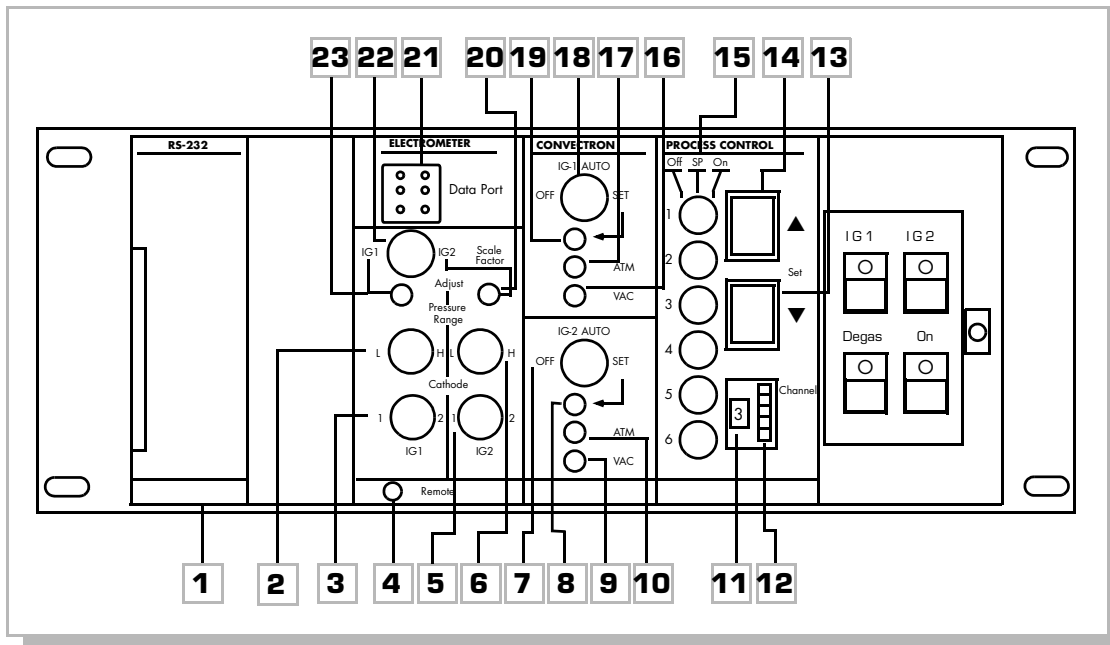

Figure 1-5 Stabil-Ion Vacuum Gauge Control Unit Front Panel (Door Open).

- | | |
|--|--|
| 1. RS-232, RS-485, or IEEE 488 Computer Interface Module | 13. Process control setpoint pressure down push-button |
| 2. Pressure range selector switch, IG1 | 14. Process control setpoint pressure up push-button |
| 3. Alternate cathode switch, IG1 | 15. Process control channel setpoint override switch |
| 4. Indicator light for remote override of functions | 16. Vacuum zero adjustment, Convectron Gauge A |
| 5. Alternate cathode switch, IG2 | 17. Atmosphere adjustment, Convectron Gauge A |
| 6. Pressure range selector switch, IG2 | 18. Auto on switch, IG1 |
| 7. Auto-on switch, IG2 | 19. Auto on adjustment, IG1 |
| 8. Auto-on adjustment, IG2 | 20. Scale factor adjustment, IG2 |
| 9. Vacuum zero adjustment, Convectron Gauge B | 21. Data port for Calibration Memory |
| 10. Atmosphere adjustment, Convectron Gauge B | 22. Scale factor display switch |
| 11. Process control channel indicator | 23. Scale factor adjustment, IG1 |
| 12. Process control channel selector thumbwheel | |

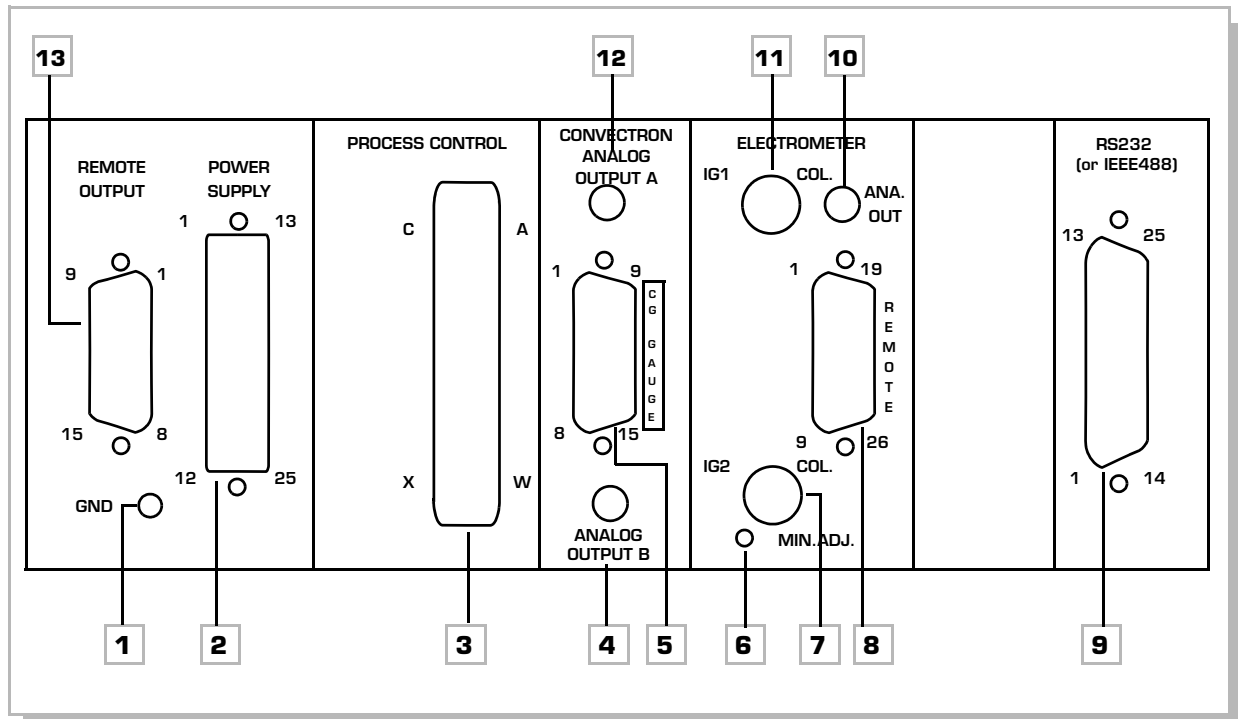

Figure 1-6 Stabil-Ion Vacuum Gauge Control Unit Rear Panel.

- | | |
|---|---|
| 1. Grounding lug to be connected to earth ground with #12 AWG conductor | 8. Connector for remote parameter selection inputs |
| 2. Interconnect cable connection from Power Supply | 9. Connector for RS-232, RS-486, or IEEE 488) computer interface |
| 3. Connector for Process Control relay contacts | 10. Connector for IG analog output voltage |
| 4. Connector for analog output voltage from Convectron Gauge B | 11. Connector for Stabil-Ion Gauge 1 |
| 5. Connector for Dual Convectron Gauge Cable | 12. Connector for analog output voltage from Convectron Gauge A |
| 6. Electrometer minimum reading calibration adjustment | 13. Connector for remote output relay contacts from Stabil-Ion Gauge 1 and Stabil-Ion Gauge 2 |
| 7. Connector for Stabil-Ion Gauge 2 | |

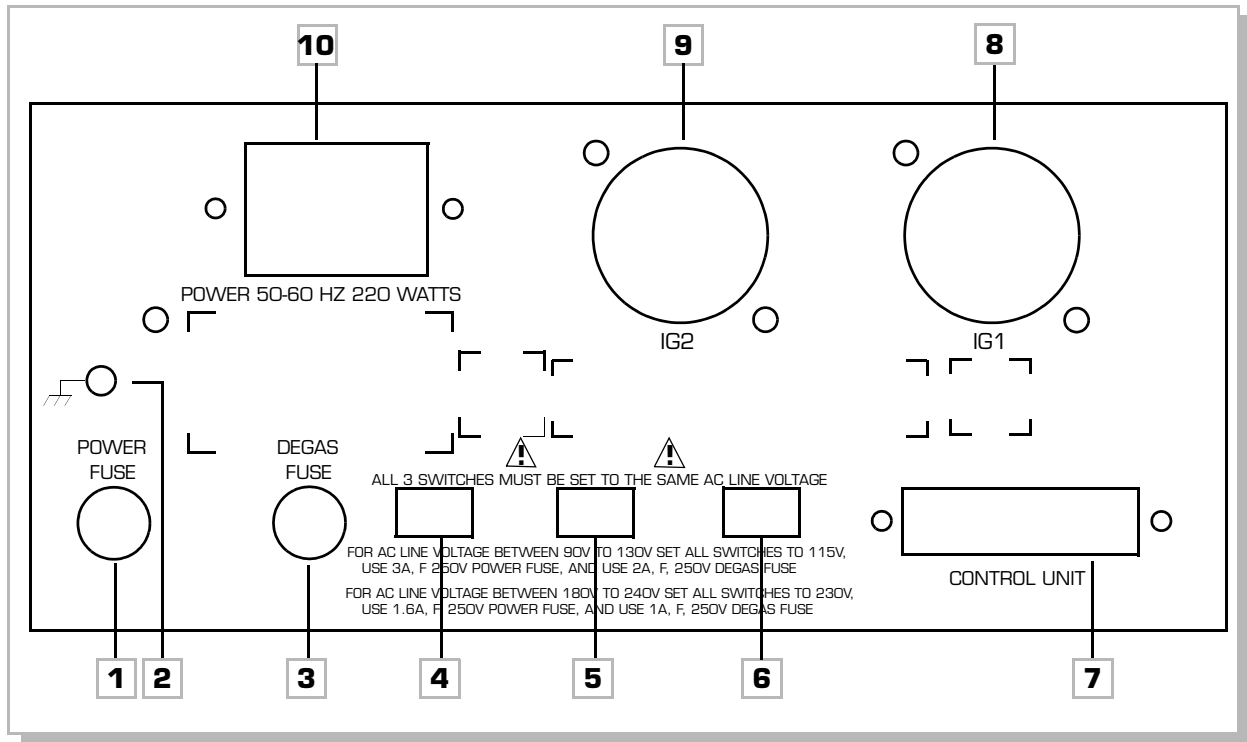

Figure 1-7 Stabil-Ion Power Supply.*

- | | |
|---|---|
| 1. Line power fuse | 6. Line voltage selector switch |
| 2. Grounding lug (connect to earth ground with #12 AWG conductor) | 7. Connector for interconnect cable to Control Unit |
| 3. Degas power fuse | 8. Connector for Stabil-Ion Gauge 1 |
| 4. Line voltage selector switch | 9. Connector for Stabil-Ion Gauge 2 |
| 5. Line voltage selector switch | 10. Connector for power cable |

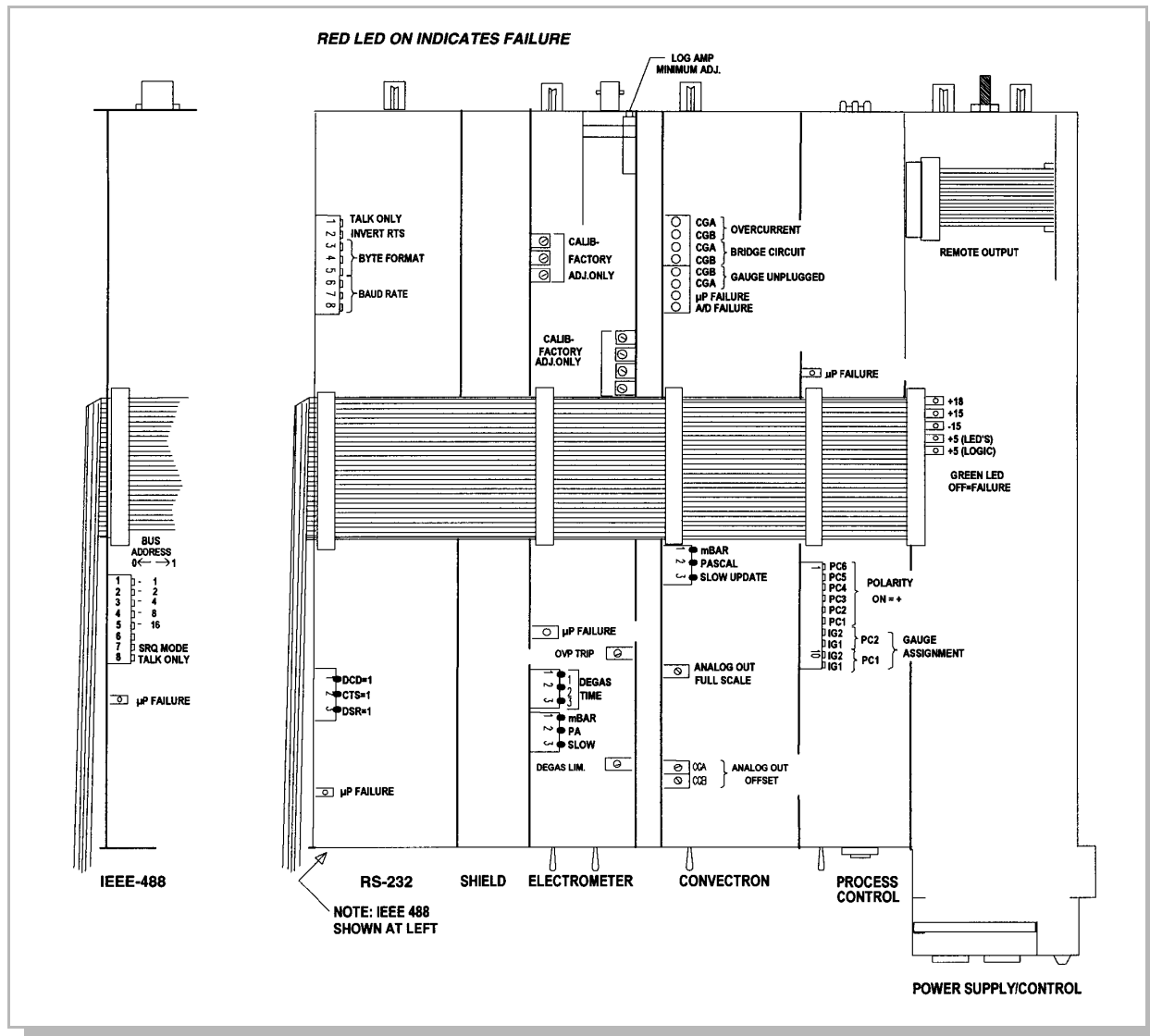

Figure 1-8 Top View of Stabil-Ion Vacuum Gauge Control Unit (Cover and Door Removed).

Initial Setup Procedures

2.1 Control Unit Setup

1. Open the front panel door and determine if any of the following options are installed:
 - Convectron Gauge
 - Process Control
 - RS-232 Computer Interface
 - RS-485 Computer Interface
 - IEEE 488 Computer Interface

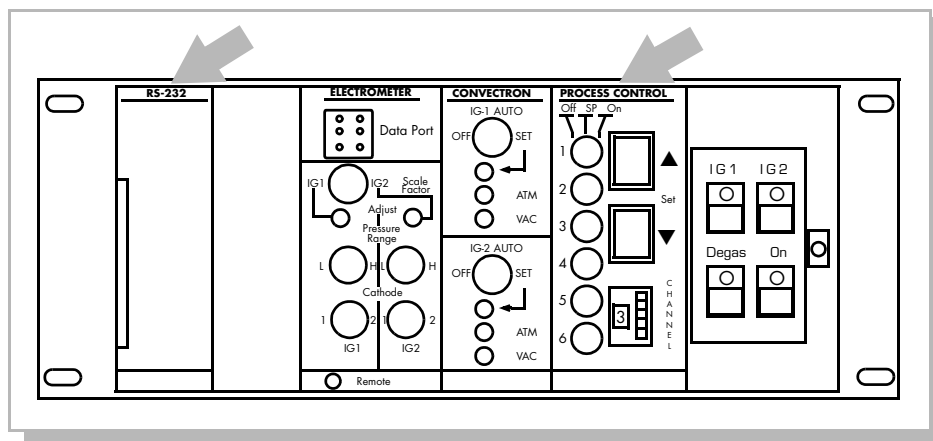

Figure 2-1 Control Unit Front Panel (with Door Open) Showing Location of Computer Interface and Process Control Modules.

2. If none of the above options are present and if the pressure display units of measure are correct (See Figure 2-2.), and you do not wish to change the degas timer from the factory setting of 10 minutes, skip to Chapter 3 Installation.
3. If one or more of the above options is present, or if you wish to change the units of measure or degas time setting, you may find it necessary to re-configure certain switches within the Control Unit.

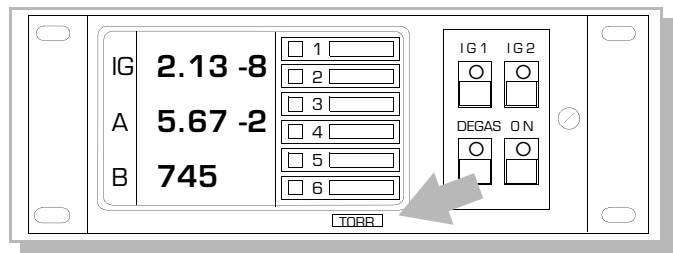

Figure 2-2 Control Unit Front Panel Showing Location of Units of Measure Label.

Review Sections 2.1.3, 2.1.4, 2.1.5, 2.1.6, 2.1.7, and 2.1.8 for the factory default settings for the switches on these options, the pressure display units of measure, and the degas timer to determine if any need changing. Now is a convenient time to make any required switch changes before mounting the Control Unit in its desired location.

2.1.1 Top Cover Removal

1. With power off, remove any cables from Control Unit rear panel.
2. Observe antistatic precautions to avoid damaging static sensitive components inside the chassis. Use a grounded, conductive work surface. Do not handle integrated circuits (IC) devices more than necessary, and only when wearing a high impedance ground strap. (A high impedance helps protect human life in case of inadvertent contact with high voltage.)

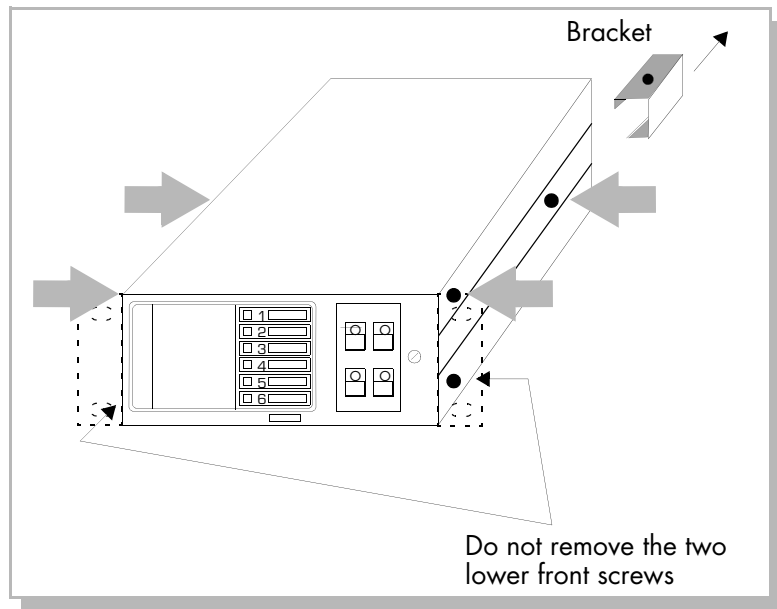

Figure 2-3 Location of Screws for Removal of Top Cover.

3. Remove the four Phillips head screws identified in Figure 2-3. If the unit is equipped with a rear bracket instead of one rear screw, unfasten the Phillips head screw on the bracket, and slide off the bracket.
4. Lift off top cover. Note the layout drawing inside the top cover.

2.1.2 Pressure Units Setup

1. Skip to Section 2.1.3 on page 2-4 if units of measure are as desired. See Figure 2-2 and Figure 2-5.

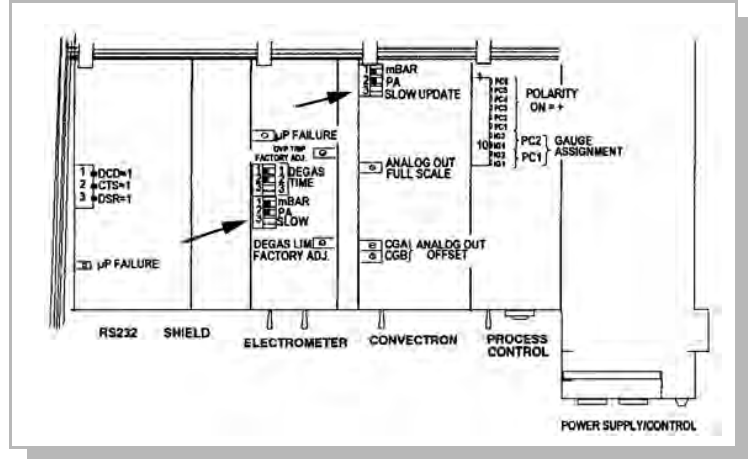

Figure 2-4 Control Unit Top View, Cover Off, Showing Locations of Switches for Pressure Display Units of Measure Selection.

2. If you wish to change the pressure display units of measure, change the settings of the units of measure switches on the Electrometer module, and on the Dual Convector Gauge module if present, as shown in Figure 2-5.

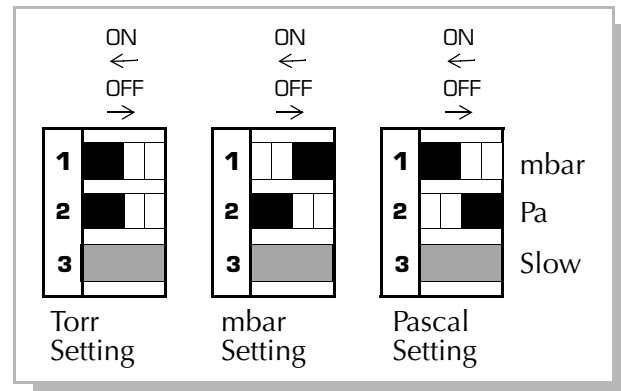

Figure 2-5 Pressure Display Units of Measure Switch Settings.

3. To change the units of measure label, open the door and lift the label card from its slot in the top of the front panel. Units of measure labels are included in the mounting hardware kit.

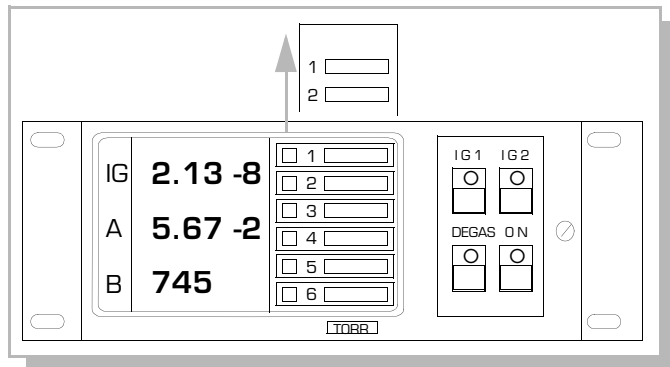

Figure 2-6 Control Unit Front Panel Showing Removal of Units of Measure Label Card.

2.1.3 Pressure Display Rate of Update

1. Skip to Section 2.1.4 on page 2-5 if units of measure are as desired. See Figure 2-2 and Figure 2-8.

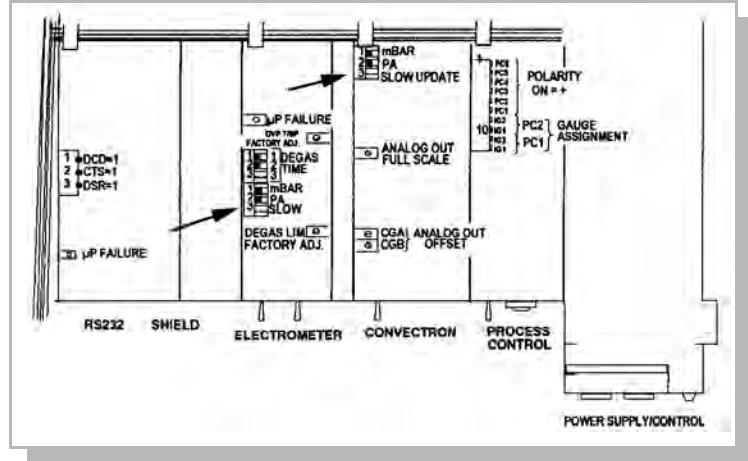

Figure 2-7 Control Unit Top View, Cover Off, Showing Locations of Switches for Pressure Display Rate of Update.

2. If you wish to change the pressure display rate of update, change the setting of the rate of update switch on the Electrometer module, and on the Dual Convectron Gauge module if present, as shown in Figure 2-8. Setting this switch "ON" will enable pressure averaging. The display will update about every three seconds with the switch "ON," and 0.5 seconds with the switch "OFF."

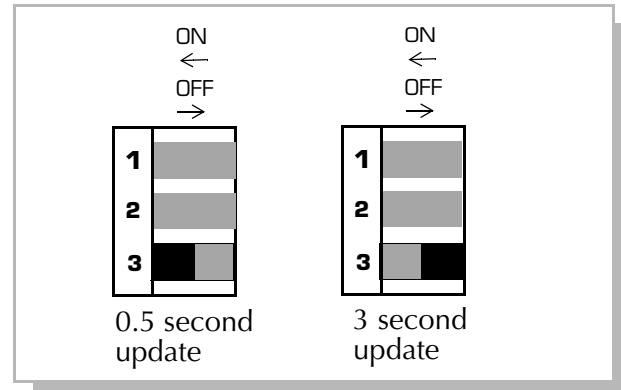

Figure 2-8 Pressure Display Rate of Update Switch Settings.

2.1.4 Process Control Setup



It is the installer's responsibility to ensure that the automatic signals provided by the product are always used in a safe manner. Carefully check the system programming before switching to automatic operation.



Where an equipment malfunction could cause a hazardous situation, always provide for fail-safe operation. As an example, in an automatic backfill operation where a malfunction might cause high internal pressures, provide an appropriate pressure relief device.

1. If you do not have process control capability skip to Section 2.1.5 on page 2-9.
2. Use the catalog number on the front of the Process Control module together with Figures 2-9, and 2-10 to identify the process control capability installed in your unit.
3. Even if the control logic is simple and obvious, we recommend that you develop a logic diagram of the process control function.
4. Prepare a specification table which lists the proposed pressure setting, system measurement point, and relay status for each Process Control channel.
5. Draw a circuit schematic which specifies exactly how each piece of system hardware will be connected to the Process Control relays.

Do not exceed the relay ratings:

Table 2-1 Relay Ratings.

Relay Configuration	SPDT (single pole, double throw)
Relay Contact Rating	5 A, 60 Vdc resistive load, 30 V rms (42.4 Vpk)
Relay Contact Type	5 A (gold plated for low level switching)

NOTE: If the relay contacts are used to switch high currents, the gold plating may be consumed. This may make the contacts unsuitable for low level signal switching in the future.

6. Attach a copy of the Process Control circuit diagram to this manual for future reference and troubleshooting.
7. The required process control connections may be made later. See Section 3.6 on page 3-8.
8. If application assistance is desired, contact a Granville-Phillips Application Engineer at the number listed on the title page of this manual.

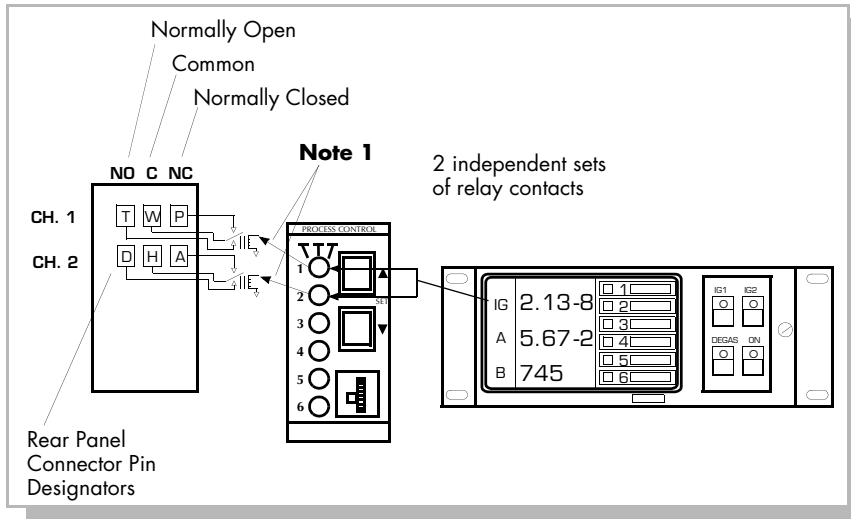

NOTE 1:

Channel 1 is user-assignable to IG1 or IG2, or IG1 and IG2.

Channel 2 is user-assignable to IG1 or IG2, or IG1 and IG2 independent of how Channel 1 is assigned.

Figure 2-9 Two Channel Process Control

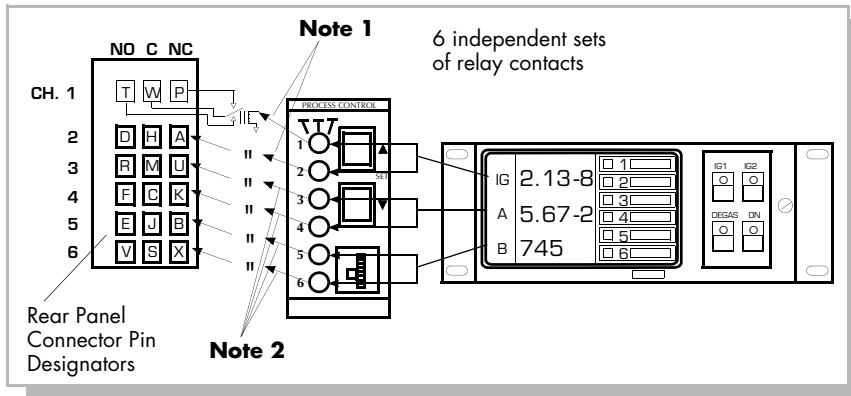

NOTE 2:

Channels 3 and 4 are factory assigned to Convectron Gauge A.

Channels 5 and 6 are factory assigned to Convectron Gauge B.

Figure 2-10 Six Channel Process Control

2.1.4.1 Ion Gauge Assignment for Process Control

A maximum of 6 process control channels are available depending on the particular option you have specified. A channel is defined as the combination of vacuum gauge indication setpoint circuitry and the associated relay which is actuated when the pressure indication corresponds to the setpoint.

Process Control channels 1 (PC1) and 2 (PC2) are controlled by the ionization gauge or gauges. Channel 1 operates relay 1. Channel 2 operates relay 2. Relays 1 and 2 are also shown as K1 and K2 on the printed circuit board for reference during IG assignment. IG1, IG2, or both can be assigned to operate either channel 1 or 2. Use Table 2-2 to assign the IG's to the channels.

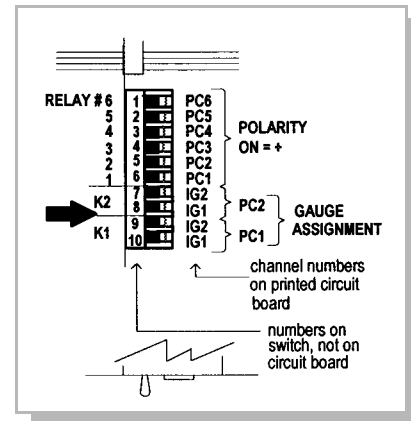

Figure 2-11 Partial Top View of Process Control Module.

Table 2-2 IG Process Control Channel Switch Settings.

Switch Settings	Function	Switch Settings	Function
	Channel 1 can turn <u>on</u> when IG1 is ON or when IG2 is ON. (factory setting)		Channel 2 can turn <u>on</u> when IG1 is ON or when IG2 is ON. (factory setting)
	Channel 1 can turn <u>on</u> when IG1 is ON and will turn <u>off</u> when IG2 is ON.		Channel 2 can turn <u>on</u> when IG1 is ON and will turn <u>off</u> when IG2 is ON.
	Channel 1 will turn <u>off</u> when IG1 is ON and can turn <u>on</u> when IG2 is ON.		Channel 2 will turn <u>off</u> when IG1 is ON and can turn <u>on</u> when IG2 is ON.
	Channel 1 will always be <u>off</u> .		Channel 2 will always be <u>off</u> .

2.1.4.2 Relay Polarity Setting

The relays can be set to activate as pressure either rises above or falls below the setpoint. A DIP switch is provided for each channel. Refer to the numbers on the printed circuit board—not on the switch body—for the channel number. Use Table 2-3 to assign relay polarity settings.

The switches are factory preset as shown below for relay activation below the pressure setpoint. This is most commonly desired when you want the relay to be de-energized under a high pressure condition.

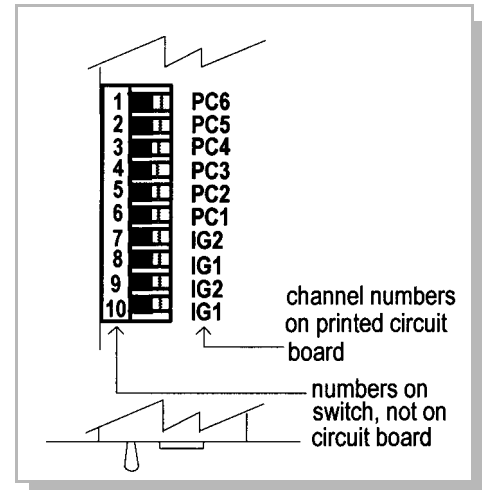

Figure 2-12 Partial Top View of Process Control Module.

Table 2-3 Relay Polarity Switch Settings.

Switch Settings	Channel Activated	Pressure Indication Relative to Setpoint	Switch Settings	Channel Activated	Pressure Indication Relative to Setpoint
	6	below*		3	below*
	6	above		3	above
	5	below*		2	below*
	5	above		2	above
	4	below*		1	below*
	4	above		1	above

* factory setting

2.1.4.3 Process Control Tips

1. The process control override switches can be used to hold relays on or off during initial turn on or during non-typical process conditions.
2. When IG1 and IG2 are off, channels 1 and 2 are inoperative.
3. When Convectron Gauges are disconnected, channels 3-6 are inoperative.
4. The status of relays 1 and 2 will not change during degas. They function as if the pressure reading was frozen when degas began.
5. Relay actuation occurs when the second digit pressure indication differs from the setpoint value by one display unit. A 10% hysteresis is automatically programmed into each setpoint for returning pressures. Table 2-4 illustrates this using an assumed setpoint pressure and assuming the polarity is set for falling pressure activation.

Table 2-4 Setpoint Hysteresis.

Setpoint Pressure	Pressure Change	Relay Actuation Pressure
6.30×10^{-7}	Falling	6.29×10^{-7}
6.30×10^{-7}	Rising	$6.30 \times 10^{-7} + 10\% = 7.00 \times 10^{-7}$

2.1.5 RS-232 Computer Interface Setup

If your Control Unit does not have this capability, skip to Section 2.1.6 on page 2-12.

This available capability permits data output to, and gauge control by, a host computer. Output is either by a command-response mechanism or by a talk-only mode which is invoked via a switch on the RS-232 board. If you have this module in your unit, configure it to your system requirements by setting the switches as directed in Section 2.1.5.1 on page 2-10.

A variety of baud rates and byte framing options are available, as well as switches to force the handshake lines to an “always true” condition.

The 360 Controller RS-232 factory defaults are: 9600 BAUD, 8 data bits, no parity, 1 stop bit; DCD, CTS, and DSR forced “true”.

The interface protocol is set using 8 switches. Refer to Figures 2-13, 2-14, and 2-15 for switch numbering.

NOTE: Internal switches are read upon 360 power up. Changes in settings will take effect upon next power-up cycle.

2.1.5.1 Selecting the Byte Format

Dip switches 6-8 may be used to set the baud rate. The settings are:

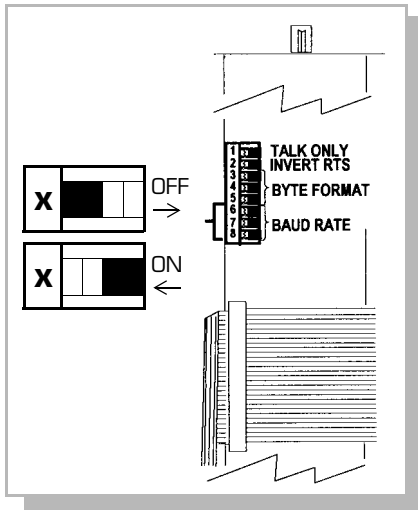

Figure 2-13 Partial Top View of Process Control Module.

Table 2-5 Baud Rate.

S6	S7	S8	Baud Rate
On	On	On	9600*
On	On	Off	4800
On	Off	On	2400
On	Off	Off	1200
Off	On	On	600
Off	On	Off	300
Off	Off	On	150
Off	Off	Off	75

* factory setting

2.1.5.1.1 Character Framing

Switches 3-5 control the number of characters, polarity, and number of stop bits:

Table 2-6 Character Framing.

S3	S4	S5	Character Bits	Parity	Stop Bits
On	On	On	8	None	2
On	On	Off	8	Even	2
On	Off	On	8	Odd	1
On*	Off*	Off*	8*	None*	1*
Off	On	On	7	Even	1
Off	On	Off	7	Odd	1
Off	Off	On	7	Even	2
Off	Off	Off	7	Odd	2

* factory setting

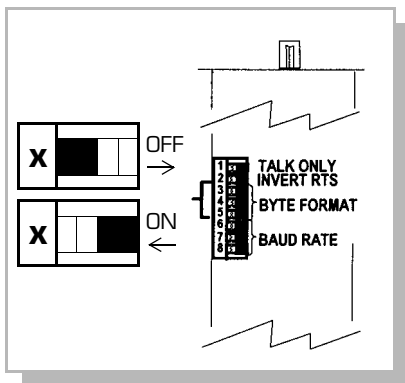

Figure 2-14 Partial Top View of RS-232 Module.

2.1.5.1.2 Talk-Only Mode

The pressure data from all three displays will be output in a single message string, separated by commas, approximately every 5 seconds. If the Convector Module is not present, only the ion gauge pressure will be output.

Table 2-7 Talk-Only Mode.

S1	Mode
Off	Talk-only
On	Command-response*

*factory setting

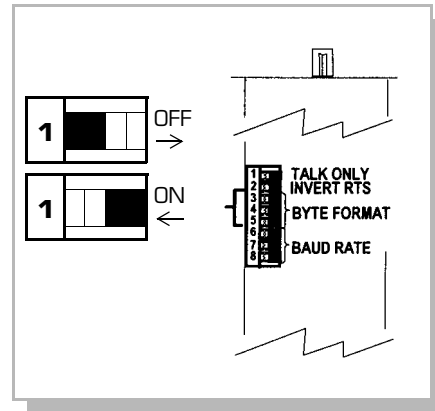

Figure 2-15 Partial Top View of RS-232 Module.

2.1.5.2 Handshaking

Table 2-8 Inputs to 360.

Line	Pin	Description	Internal Switch Function	Factory Setting
CTS & DSR	5	CLEAR to SEND and DATA SET	CTS=1 and DSR=1: When ON, forces the functions TRUE and thus assumes host is always ready to receive.	Both ON
	6	READY: When used, both must be TRUE in order for 360 to send the next byte in its message or data.		
DCD	8	DATA CARRIER DETECT: Must be TRUE at the time each character is received or that character will be ignored by 360.	DCD=1: When ON, forces DCD function TRUE so 360 will receive all characters sent to it (as long as RTS is in de-asserted state).	ON

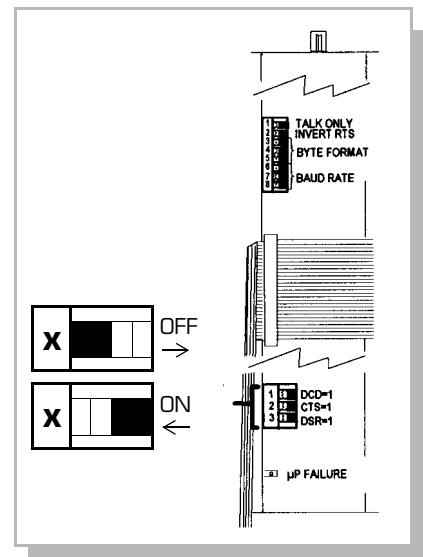

Figure 2-16 Top View of RS-232 Module.

Table 2-9 Outputs from 360.

Line	Pin	Description	Internal Switch Function	Factory Setting
RTS	4	REQUEST TO SEND: De-asserted by 360 on power-up. Asserted by 360 upon receipt of a message terminator as a hold off to prevent the host computer from attempting to transmit data until the message just received has been parsed and a reply has been output. De-asserted after transmitting the terminator of 360's response to that message.	INVERT RTS: When OFF inverts the polarity of the RTS line allowing nonstandard connection directly to host computer CTS line. When ON, set to operate as a modem line per RS-232 standard.	ON
DTR	20	Always asserted by 360. A "power on" indication.		

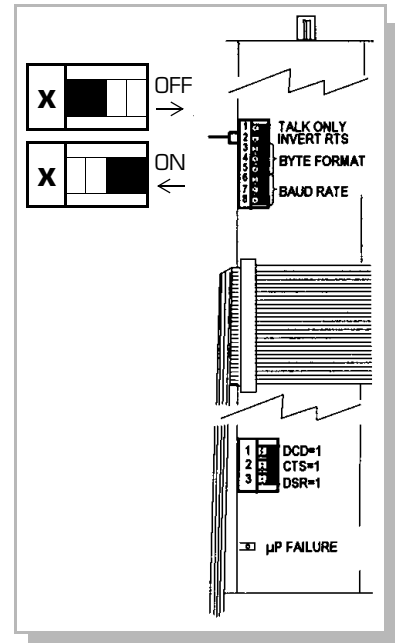

Figure 2-17 Top View of RS-232 Module.

NOTE: When 360 receives a start bit on the received data line, it will input and buffer a character. 360 will continue to receive and buffer characters until the terminator (LF) is received.

2.1.6 RS-485 Computer Interface Setup

If your Series 360 Stabil-Ion Gauge Controller does not have this capability, skip to Section 2.1.7 on page 2-15.

The RS-485 communications option for the Series 360 Stabil-Ion Gauge Controller permits data output to, and gauge control by, a host computer using RS-485 digital communications. Communications handshake is by a command-response mechanism.

A variety of baud rates and byte framing options are available. The RS-485 byte format is configured to your system requirements using configuration switches located on the option board. These switches are accessed by removing the controller top chassis cover.

The RS-485 factory defaults are:

- 9600 BAUD, 8 character bits, no parity, 1 stop bit, Address = 01

Internal switches are read upon power up. Changes in settings will take effect upon next power-up cycle.

2.1.6.1 RS-485 Address

The address dial on the RS-485 module on the back of the controller and Switch S1 determine the controller's RS-485 address. This address can be any hex code from 00 to FF.

The address dial on the RS-485 module on the back of the controller determines the value of the least significant digit and the S1 switches determine the value of the most significant digit. The S1 switch positions are binary and the weight of each switch when OFF is given in Table 2-10.

To prevent data contentions, no two RS-485 nodes should be set with the same address. It is not recommended that address 00 be used because some manufacturers use this address for configuration.

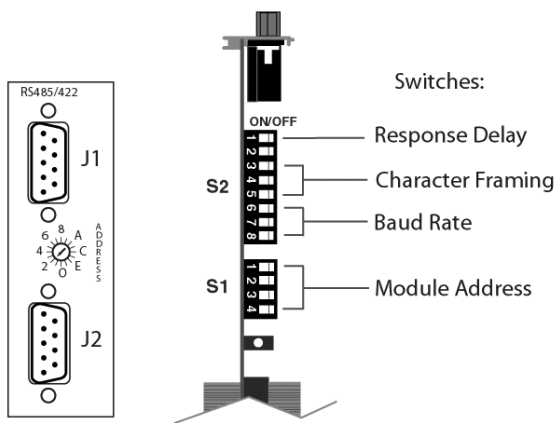

Table 2-10 Switch Weight When OFF

Switch	Weight
S1.1	10 Hex
S1.2	20 Hex
S1.3	40 Hex
S1.4	80 Hex

Figure 2-18 Back Panel and Top View of RS-485 Module

2.1.6.2 Response Delay for the RS-485 Interface

Switch S2.1, Figure 2-18, enables a delay of the response from the module of 10 to 13 MS + 10 bit times when OFF. When S2.1 is ON, the delay is greater than 700 microseconds. The factory default setting is ON, with a delay greater than 700 microseconds.

2.1.6.3 Selecting the Byte Format for RS-485 Communications

2.1.6.3.3 Baud Rate

Baud rate for the RS-485 communications is determined by the settings of switches S2.6, S2.7 and S2.8. See Figure 2-18. Table 2-11 defines the baud rate base on the switch settings. The factory default baud rate setting is 9600.

Table 2-11 Baud Rate Switch Settings

S2.6	S2.7	S2.8	Baud Rate
ON*	ON*	OFF*	9600*
ON	OFF	ON	4800
ON	OFF	OFF	2400
OFF	ON	ON	1200
OFF	ON	OFF	600
OFF	OFF	ON	300
OFF	OFF	OFF	150

2.1.6.3.4 Character Framing for the RS-485 Computer Interface

Character framing for the RS-485 computer interface is determined by setting switches S2.3, S2.4, and S2.5. See Figure 2-18. Table 2-12 defines the character bits, parity, and stop bits based on the switch settings. The factory default setting is S2.3 On, S2.4 Off, and S2.5 Off - Character bits set to 8, Parity None, and Stops bits at 1.

Table 2-12 Character Framing Switch Settings

S2.3	S2.4	S2.5	Character Bits	Parity	Stop Bits
ON	ON	ON	8	None	2
ON	ON	OFF	8	Even	1
ON	OFF	ON	8	Odd	1
ON	OFF	OFF	8*	None*	1*
OFF	ON	ON	7	Even	1
OFF	ON	OFF	7	Odd	1
OFF	OFF	ON	7	Even	2
OFF	OFF	OFF	7	Odd	2

* factory setting

2.1.7 IEEE 488 Computer Interface Setup

If your Control Unit does not have this capability, skip to Section 2.1.8 on page 2-16.

This available capability permits data output to, and gauge control by, a host computer. Output is either by a command-response mechanism or by a talk-only mode which is invoked via a switch on the IEEE 488 board. If you have this capability in your unit, configure it to your system requirements by setting the switches as directed below.

NOTE: Internal switches are read upon 360 power up. Changes in settings will take effect upon next power-up cycle.

To configure the IEEE 488 bus to operate via SRQ interrupts, a switch is provided which will cause the 360 to generate an SRQ and wait for a serial poll before outputting each message.

2.1.7.1 Selecting the Interface Bus Address

Refer to Figure 2-19 and locate switches 1 through 5. Each instrument on the IEEE 488 bus has an address from 0 to 30. The address for this product is set at the factory to "8". The user must ensure that every device on his bus has a unique address. To select an address, switches 1 through 5 are adjusted according to binary weights:

Table 2-13 Interface Bus Address Values When OFF.

Switch Number	5	4	3	2	1
Value when OFF	16	8	4	2	1

Table 2-14 Example Switch Settings.

Switch Number	5	4	3	2	1	Address
Setting	On	Off	On	On	On	8*
	On	On	Off	Off	Off	7
	Off	Off	Off	On	On	28

* Factory default setting

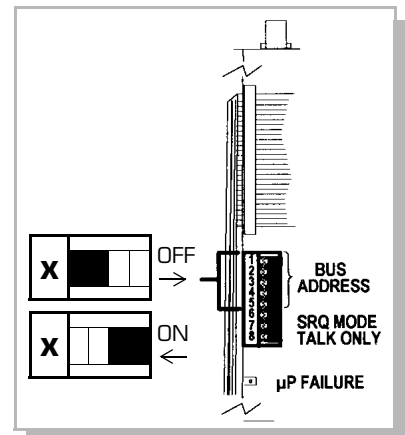

Figure 2-19 Top View of IEEE 488 Module.

2.1.7.2 Talk-Only Mode

Switch 8, if set to **off** during power up, places the interface in talk-only mode. The pressure data from all three displays will be output in a single message string, separated by commas, approximately every 5 seconds. If no Dual Convectron Gauge module is present, only the ion gauge pressure will be output. The factory default is talk-only disabled (switch 8 **on**).

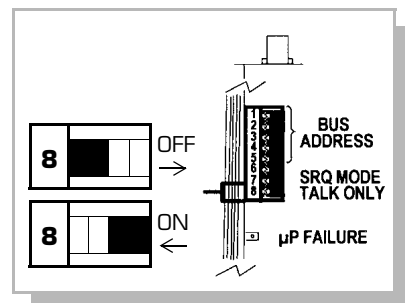

Figure 2-20 Top View of IEEE 488 Module.

2.1.7.3 SRQ Mode

Switch 7, if set to **off** during power up, tells the interface to generate an SRQ interrupt and expect a serial poll before every message output. The SRQ bit will be released when there is a Serial Poll or when the message is read. The factory default is SRQ mode disabled (switch 7 **on**). The serial poll response byte will contain a 1 in bit 4 (this bit is also the MAV (message available) bit). Bit 6 will be set if an error has occurred. In this case the pending message will be an error message.

Switch 6 is not used.

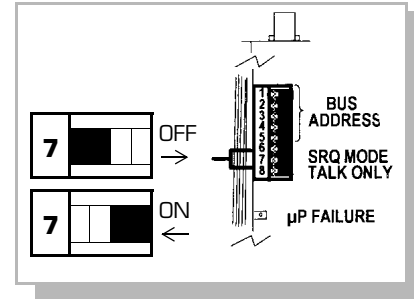

Figure 2-21 Top View of IEEE 488 SRQ Switches

2.1.8 Degas Timer

If you do not wish to change the factory setting, skip to Section 2.1.9 on page 2-17.

NOTE: The degas timer is preset for 10 minutes. This is the recommended setting for most applications.

If a Stabil-Ion Gauge is installed with the Cable Connector on top, degas time must be limited to 10 minutes/hr. to prevent the Connector from overheating.

To change the degas time:

1. Confirm that power is off and all cables are removed from the rear of the Control Unit.
2. Set the degas time switches on the electrometer module as shown below.

Table 2-15 Degas Time Switch Settings.

Degas Time (Min.)	Switch Setting		
	1	2	3
1	Off	Off	On
2	Off	On	Off
5	Off	On	On
10*	On*	Off*	Off*
15	On	Off	On
20	On	On	Off
30	On	On	On

* factory setting

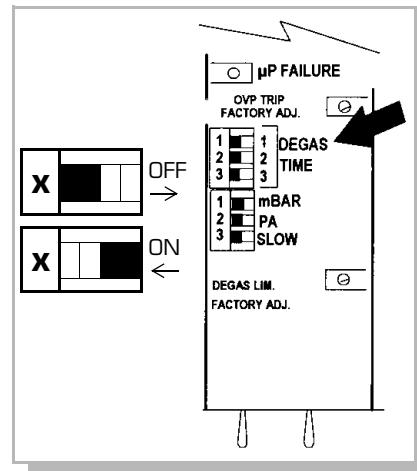

Figure 2-22 Top View of Electrometer Module Showing Degas Time Switches.

2.1.9 Replacing Control Unit Cover

Assuming you have completed the above instructions, the Control Unit setup is now complete. Replace the top cover. Make sure the door hinge pin is seated correctly. Replace the four top cover Phillips head screws (or three screws plus bracket screw).

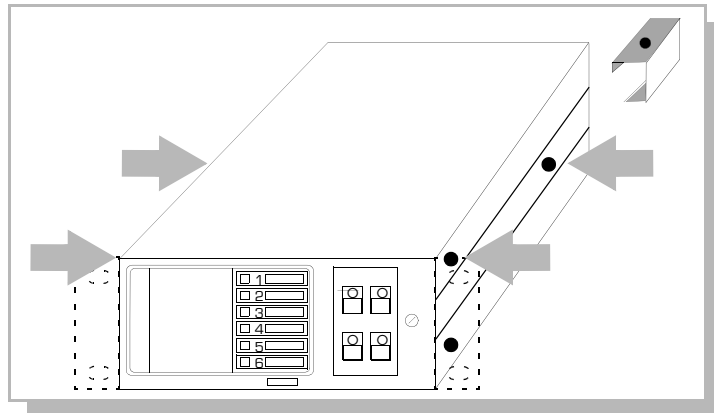

Figure 2-23 Location of Screws for Replacing Top Cover.

2.2 Power Supply Setup

1. With all cables disconnected, check to see that the line voltage selector switches on the back of the power supply are set to local line voltage. Incorrect settings may cause extensive damage to the product.

AC Line Voltage between 90V to 130V

For AC line voltage between 90V to 130V set all switches to 115V as shown to the right. Use 3A, F, 250V Power Fuse, and use 2A, F, 250V Degas Fuse (see Note 1).

90 – 130 V 50/60 Hz



Replacement fuses are available from the vendors below, or from Granville-Phillips at the address on the title page of this manual.

NOTE 1: (115V Nom) Power Fuse is: Littelfuse #312-003, or BUSS #AGC-3, or GP #009325
Degas Fuse is: Littelfuse #312-002, or BUSS #AGC-2, or GP #009324

When going from 230V to 115V, two new fuseholders are required: SHURTER #0131.1666 or GP #006966

AC Line Voltage between 180V to 240V

For AC line voltage between 180V to 240V set all switches to 230V as shown to the right.

Use 1.6A, F, 250V Power Fuse, and use 1A, F, 250V Degas Fuse (see Note 2).

180 – 240 V 50/60 Hz



Replacement fuses are available from the vendors below, or from Granville-Phillips at the address on the title page of this manual.

NOTE 2: (230V Nom) Power Fuse is: Littelfuse #21601.6, or SHURTER #FSF034.1518, or GP #009323

Degas Fuse is: Littelfuse #217001, or SHURTER #FSF034.1516, or GP #009322

When going from 115V to 230V, two new fuseholders are required: SHURTER #031.1663 or GP #006965

2. Replace the fuses whenever the switch settings are changed with correct fuse values as indicated on the power supply panel.
3. Do not connect power cables until the Installation Instructions in Chapter 3 are completed.
4. The 360 VGC is supplied with a convenient IEC 320 AC mains connection receptacle which allows selection of a detachable line cord to match your available mains power.

Installation



It is the installer's responsibility to ensure that the automatic signals provided by the product are always used in a safe manner. Carefully check the system programming before switching to automatic operation.



Where an equipment malfunction could cause a hazardous situation, always provide for fail-safe operation. As an example, in an automatic backfill operation where a malfunction might cause high internal pressures, provide an appropriate pressure relief device.

3.1 Gauge Installation Tips

For best results locate pressure gauges close to the point where pressure is to be measured. Gas sources, long tubulation or other constrictions can cause large errors in indication. Note that if placed near the pump, the pressure in the gauge may be considerably lower than in the rest of the system. If placed near a gas inlet or source of contamination, the pressure in the gauge may be much higher.

To minimize temperature effects, locate pressure gauges away from internal and external heat sources in a region where the ambient temperature is reasonably constant.

Parts of the gauge can get quite hot during degassing, especially if there is poor ventilation. This will not damage the gauge. However, care should be taken to prevent low temperature rated materials such as plastic wire insulation from touching hot parts of the gauge.

3.1.1 EMC Compliance

In order to comply with the standards for immunity as called for by the EMC Directive, careful consideration to grounding and shielding of instrumentation cables is required. User-supplied cables must have the drain shield of the cable connected to chassis ground. Immunity to radiated and conducted RF energy in industrial environments will depend on cable construction and routing. The VGC system will perform within the typical uncertainty of a Stabil-Ion Gauge system when subjected to industrial levels of RF energy.

Snap-on ferrite sleeves (G-P P/N 013746, 4 ea. provided) must be installed on the ion gauge cable at both the gauge tube end and Controller end of the cable. Failure to install these ferrite suppression cores may result in non-compliance with the EU EMC Standards for Industrial Level Immunity.

3.1.2 Cable Installation Statement

It is intended that all wiring either to or from the Stabil-Ion Gauge Controller unit, whether supplied by Granville-Phillips or not, be installed in accordance with the safety requirements of NEC/NFPA 70. Cables provided by Granville-Phillips for connection to sensors or transducers is, at a minimum, designed for use as Appliance Wiring Material (UL category AVLV2), and is constructed of appropriate material and dimensions for the voltages and currents provided by the Stabil-Ion Gauge Controller unit. It is emphasized that it is the user's responsibility to install cables to/from the Stabil-Ion Gauge Controller unit, whether provided by Granville-Phillips, or not, in accordance with the applicable local, state, and national safety requirements.

Raceway and/or conduit may be needed for certain installations.

3.1.3 Environmental Conditions

Indoor Use.

Altitude up to 2000 meters.

Temperature 0 °C to 40 °C.

Maximum relative humidity 80% for temperatures up to 31 °C decreasing linearly to 50% relative humidity at 40 °C.

Transient overvoltages according to INSTALLATION CATEGORY (over-voltage category) II.

POLLUTION DEGREE 2 in accordance with IEC664.

3.2 Stabil-Ion Gauge Installation



Verify that the vacuum port to which the Stabil-Ion Gauge is mounted is electrically grounded. It is essential for personnel safety as well as proper operation that the envelope of the gauge be connected to a facility ground. Use a ground lug on a flange bolt if necessary.

- The Stabil-Ion Gauge is double packaged at the factory for cleanroom compatibility. Handle the gauge carefully to avoid damage to the vacuum port screen after the hard plastic packaging is removed. To reduce the chance of contamination, do not remove a Stabil-Ion Gauge from its inner bag until moments before it is to be connected to the vacuum system.
- Any mounting orientation may be used. However, to minimize the possibility of excessive temperature at the electrical connector when degassing, do not install the Stabil-Ion Gauges with the electrical connector above the gauge. If it is necessary to install the gauge with the connector on top, degas time must be limited to 10 minutes/hour. See Section 2.1.8 on page 2-16. When mounted horizontally, the ventilation slots in the Guard will be oriented for best cooling if the gauge is installed with the locating key in the pin guard on the bottom. See Figure 3-1 and Figure 3-3. Note in Figure 3-3 that the cable will exit in the direction the locating key is oriented.

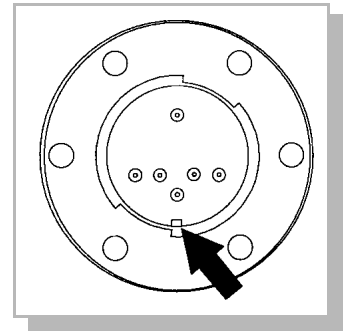

Figure 3-1

Stabil-Ion Gauge Showing Connector Locating Key.

For best results, locate pressure gauges close to the point where the pressure is to be measured. Gas sources, long tubulation or other constrictions can cause large errors in indication. If the gauge is placed near the pump, the displayed pressure may be considerably lower than the rest of the system. If the gauge is placed near a gas inlet or source of contamination, the displayed pressure may be much higher.

To minimize temperature effects, locate pressure gauges away from internal and external heat sources in a region where the ambient temperature is reasonably constant. Avoid mounting the gauge near strong magnetic fields.

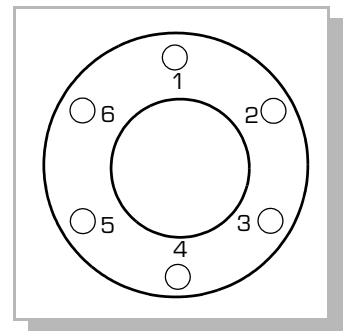

Figure 3-2

ConFlat Flange Bolt Locations.

- Avoid contaminating the Stabil-Ion Gauge. Do not touch the port. Do not talk directly at an open vacuum port. Follow good vacuum practice.
- To minimize the possibility of leaks with ConFlat flanges, use high strength stainless steel bolts and a new, clean OFHC copper gasket. Avoid scratching the seal surfaces. Do not use nonmetal gaskets.
- After finger tightening all bolts, continue tightening about 1/8 turn in crisscross order, e.g., 1, 4, 2, 5, 3, 6, 4, 1, 5, 2, 6, 3, 1.... until the flanges are in contact. After contact, further tighten each bolt about 1/16 turn. See Figure 3-2 on page 3-2.

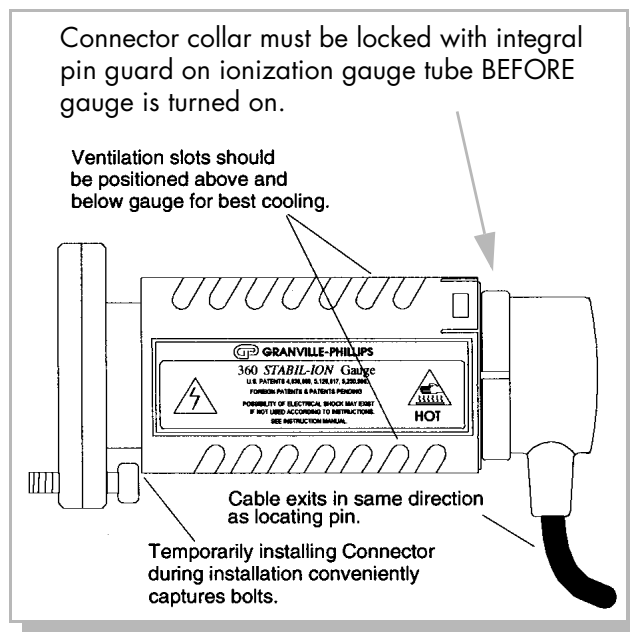

Figure 3-3 Stabil-ion Gauge with Connector and Guard.

3.3 Convecatron Gauge Installation



When high voltage is present, all exposed conductors of a vacuum must be maintained at earth ground.

Under certain conditions, dangerous high voltage can be coupled directly to an ungrounded conductor through a gas almost as effectively as through a copper wire connection. This hazard, which is not peculiar to this product, is a consequence of the ability of an electric current to flow through a gas under certain circumstances. A person may be seriously injured, or even killed by merely touching an exposed ungrounded conductor at high potential.

When high voltages are used within the vacuum system and the Convecatron Gauge envelope is not reliably grounded through its vacuum connection, either a separate ground wire must be added, or the envelope must be shielded to positively prevent human contact. The gauge envelope may be grounded by using a metal hose clamp on the gauge connected by a #12 awg copper wire to the grounded vacuum chamber.

High voltage can couple through a gas to the internal electrodes of a gauge. Do not touch the exposed pins on any gauge installed on a vacuum system where high voltage is present.

If the Convecatron option is used with the Series 360, only Series 275 Convecatron Gauge tubes manufactured in June of 1997 or later can be used on the units bearing the CE mark. Each gauge tube is marked with a date code. This date code must be F7 (June 1997) or after.

- Cleanliness pays. Keep the port cover in place until moments before installation.
- For proper operation above about 1 Torr, install Convecatron Gauges with the gauge axis horizontal. To minimize pressure indication errors, avoid installing the Convecatron Gauge where it will vibrate. Vibration causes convection cooling of the sensor and will cause the pressure indication to be high.

- Do not mount the gauge in a manner such that deposition of process vapors upon the internal surfaces can occur through line-of-sight access to its interior. If condensates may be present, orient the port downward to help liquids drain out.

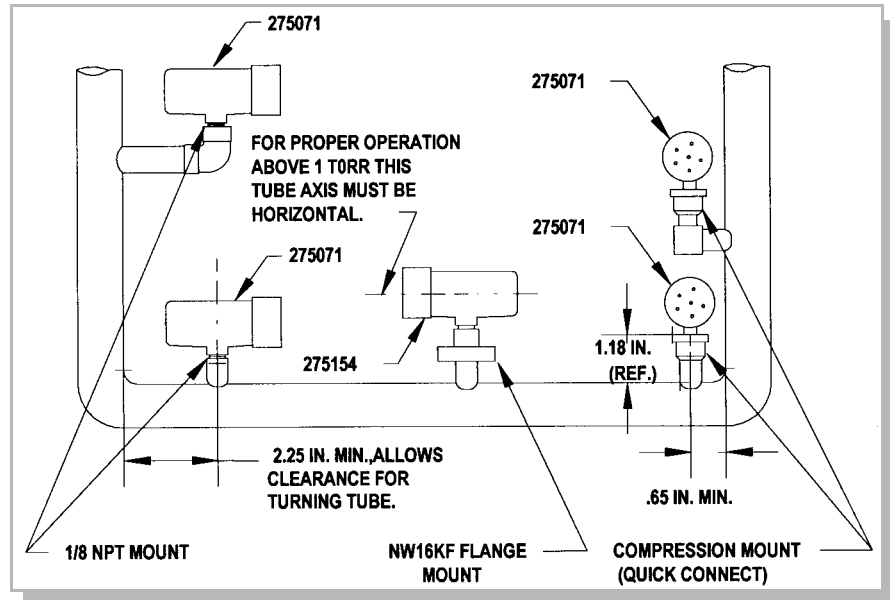

Figure 3-4 Convectron Gauge Installation.

3.3.1 Compression Mount/Quick Connect

Do not use for positive pressure applications. The gauge may be forcefully ejected.

The gauge port is designed to fit a standard 1/2 in. compression/quick connect mounting such as an Ultra-Torr¹ fitting.

3.3.2 1/8 NPT Mount

Fits standard 1/8 NPT female fitting. Wrap the threads of the gauge port with thread sealant tape and hand tighten. Do not use a wrench or tool. Tighten only sufficiently to achieve a seal.

3.3.3 VCR®/VCO® Mount

Remove the plastic or metal bead protector cap from the bead. When using gasket, place it into the female nut where applicable. Assemble components and snug finger-tight. While holding a back-up wrench stationary, tighten the female nut 1/8 turn past finger-tight for 316 stainless steel and nickel gaskets; or 1/4 turn past finger-tight for copper and aluminum gaskets.

3.3.4 NW16KF Flange Mount

The KF mounting system requires an O-ring and centering ring to be placed between the mating flanges. The flanges are then held together with the aluminum flange clamp by tightening the wing nut. Maximum pressure for this style mounting system is 1000 Torr absolute.

3.3.5 ConFlat Flange Mount

- To minimize possibility of leaks with ConFlat flanges, use high strength stainless steel bolts and a new, clean OFHC copper gasket. Avoid scratching the seal surfaces. To avoid contamination, do not use nonmetal gaskets.
- After finger tightening all bolts, continue tightening about 1/8 turn in crisscross order, e.g., 1, 4, 2, 5, 3, 6, 4, . . . until flanges are in contact. After contact, further tighten each bolt about 1/16 turn.

1. Ultra-Torr, VCR, and VCO are registered trademarks of Cajon Co.

3.4 Installing the Control Unit and Power Supply

1. Provide adequate ventilation for the Control Unit to dissipate 15 watts and for the Power Supply to dissipate 50 watts. ALLOW AT LEAST 1 IN. CLEARANCE AROUND THE SIDE AND TOP VENTILATION SLOTS ON THE POWER SUPPLY.
2. Do not mount the Control Unit or Power Supply above other equipment that generates excessive heat.
3. This product is designed to operate over the range 0-50 °C. Ambient temperatures above 50 °C may damage the product. For optimum electrometer calibration stability, the Control Unit ambient temperature should be 25 ±5 °C.

3.4.1 Grounding the System

1. Connect a heavy duty ground wire #12 AWG or larger from the ground lugs on the backs of the Power Supply and the Control Unit to your facility grounding electrode system. This will provide an earth ground for the Power Supply and for the Control Unit in the event either the interconnect cable or power cable are not in place. Do not connect the ground lug to the vacuum system or other component. Connect it directly to the facility grounding system such as a grounded outlet box or a grounded copper water supply pipe. Do not rely on small metal water lines to ground a component. Later on someone may replace the metal tubing with plastic tubing thus unwittingly causing a potentially dangerous situation.



Be aware that an electrical discharge through a gas may couple dangerous high voltage directly to an ungrounded conductor almost as effectively as would a copper wire connection. A person may be seriously injured or even killed by merely touching an exposed ungrounded conductor at high potential.

This hazard is not unique to this product.

2. Provide a connection to ground for other instruments with electrodes in the vacuum system possibly exposed to high voltage electrical discharges.
3. Provide a connection to ground for each ungrounded metal component in, on or around the vacuum system, including the gauge envelopes, which personnel may touch and which can potentially be exposed to high voltage electrical discharges within the vacuum system. For example, a metal bell jar resting on an organic O-ring must be connected to ground if an ionization gauge is to be used or if other high voltage sources are present in the vacuum system.



Compliance with the usual warning to connect the power cable only to a properly grounded outlet is necessary but not sufficient for safe operation of a vacuum system with this or any similar high voltage producing product. Grounding this product does not and cannot guarantee that other components of the vacuum system are all maintained at earth ground.



All conductors in, on, or around the vacuum system that are exposed to potential high voltage electrical discharges must either be shielded at all times to protect personnel or must be connected to earth ground at all times.

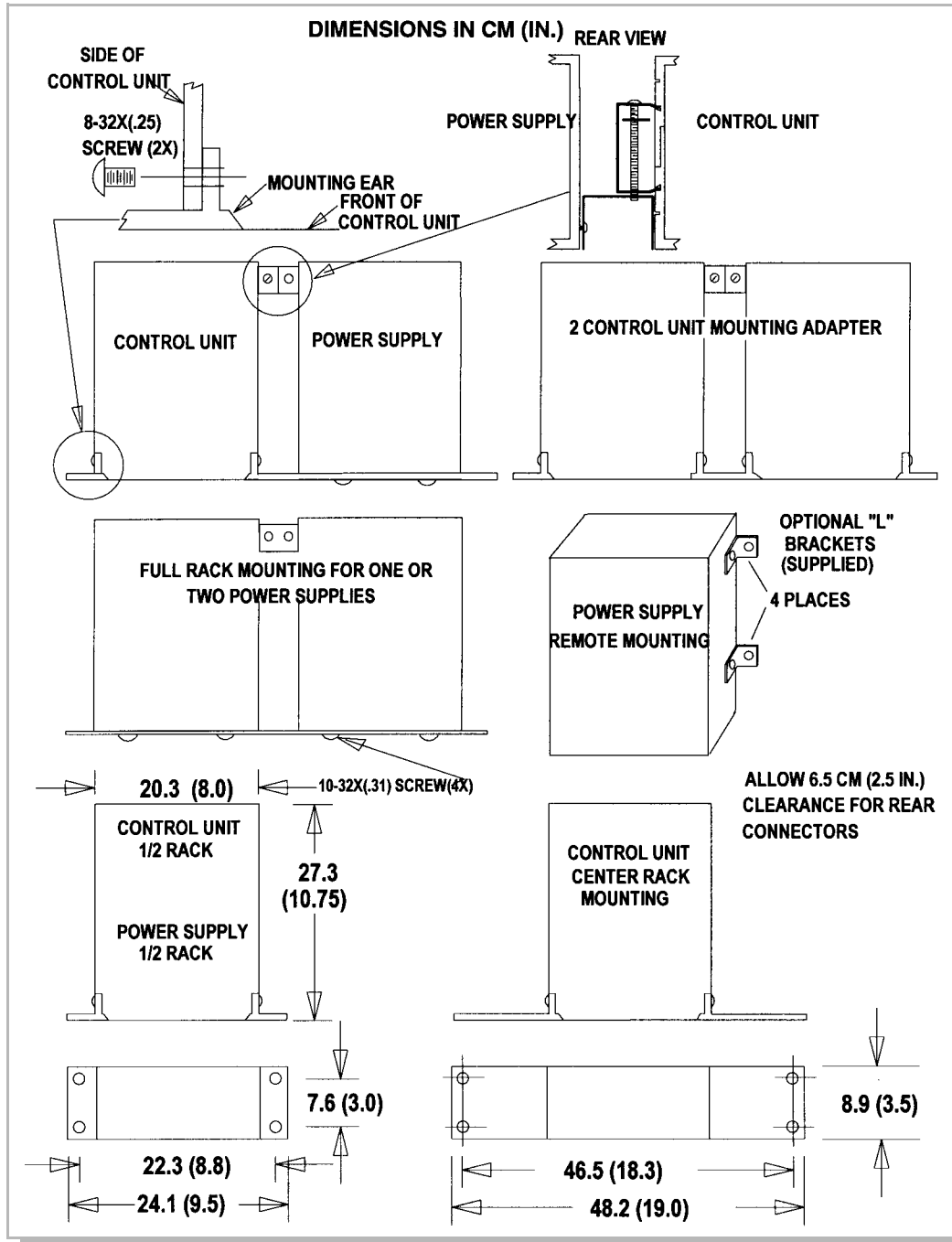

Figure 3-5 Control Unit and Power Supply Mounting.

3.5 Connecting Analog Outputs

3.5.1 Stabil-Ion Gauge Analog Output Signal

A signal voltage proportional to the logarithm of the Stabil-Ion Gauge pressure indication is provided on the back of the electrometer module via a standard 1/8 in. miniature phone jack. A mating connector is supplied in the hardware kit. See Section 4.5 on page 4-10 pertaining to the characteristics of this signal.

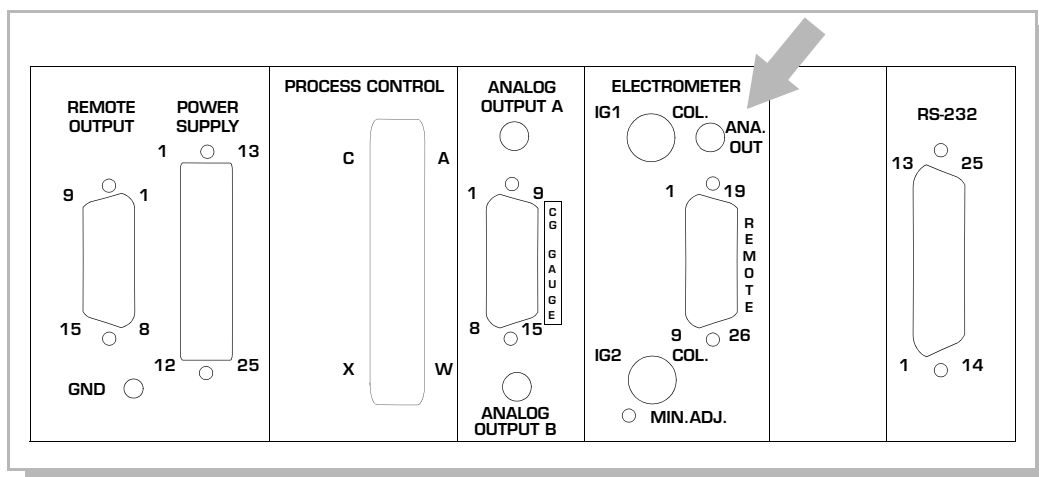

Figure 3-6 Stabil-Ion Gauge Analog Output Connector Location on Rear Panel of Control Unit.

3.5.2 Convectron Gauge Analog Output Signal

If you have Convectron Gauge capability installed, signal voltages proportional to the logarithm of the Convectron Gauge display indications are provided on the back of the Convectron Gauge module via a standard 1/8 in. miniature phone jack. Two mating connectors are supplied with this capability. See Section 4.9 on page 4-23 pertaining to the characteristics of these signals.

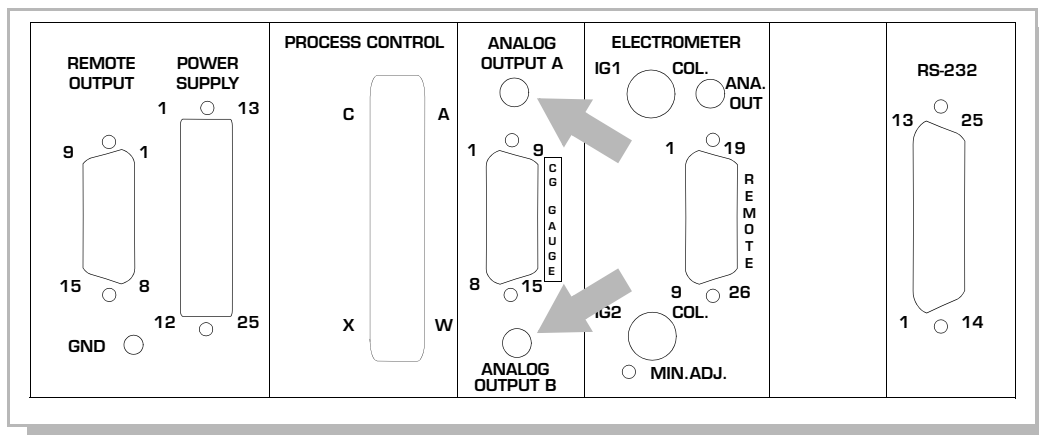

Figure 3-7 Convectron Gauge Analog Output Connector Locations on Rear Panel of Control Unit.

3.6 Connecting Process Control Relays

Instructions for setting up this module are in Section 2.1.4 on page 2-5.

The process control connector is embossed with letters identifying each pin. Table 3-1 shows the letters designating the 3 pins assigned to each of the 6 channels.

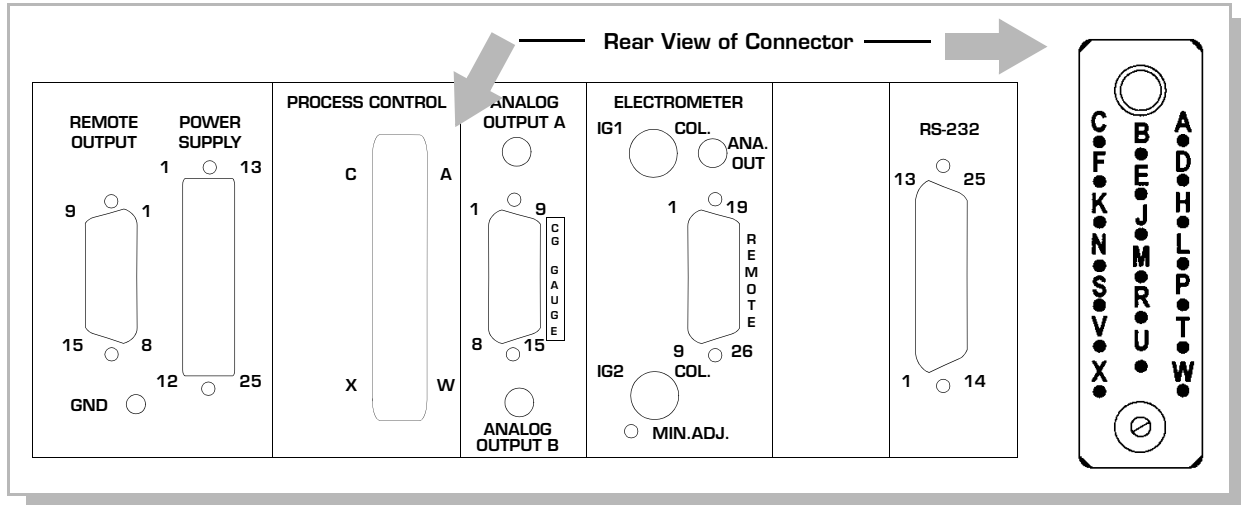



Figure 3-8 Process Control Output Connector Location on Rear Panel of Control Unit.

Table 3-1 Process Control Output Connector Pin Assignments.

Process Control Channel	IG		A		B	
	1	2	3	4	5	6
Common (or Pole)	W	H	M	C	J	S
Normally Closed (NC)	P	A	U	K	B	X
Normally Open (NO)	T	D	R	F	E	V
CHASSIS GND – PIN L			NO CONNECTION – PIN N			

A mating connector is supplied in the hardware kit.

 **It is the installer's responsibility to ensure that the automatic signals provided by the product are always used in a safe manner. Carefully check the system programming before switching to automatic operation.**

 **Where an equipment malfunction could cause a hazardous situation, always provide for fail-safe operation. As an example, in an automatic backfill operation where a malfunction might cause high internal pressures, provide an appropriate pressure relief device.**

- Using Table 3-1 and circuit schematics you have prepared, make up a cable to connect the various system components which are to be controlled. Unambiguous labeling of each lead will help prevent costly mistakes.

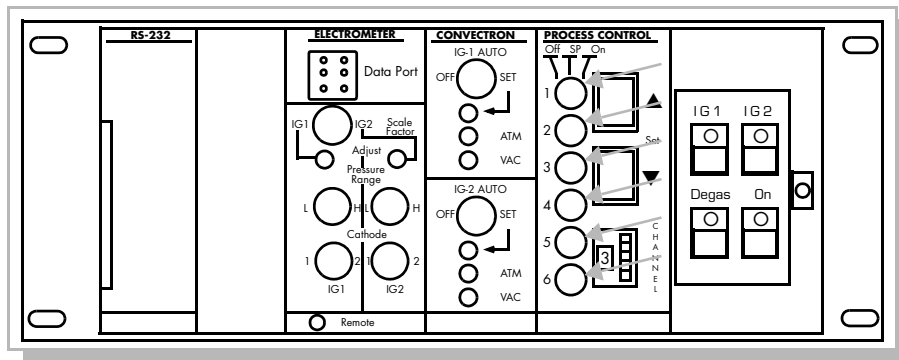

Figure 3-9 Front Panel of Control Unit (with Door Open) Showing Locations of Override Switches.

- Ensure that the Process Control channel override switches are all set to off.
- Connect the component end of the cable to the system component to be controlled.
- Plug the connector into the back of the Control Unit.
- Refer to Section 4.10 on page 4-24 for instructions for setting setpoints.

3.7 Connecting Stabil-Ion Remote Control

This factory installed option permits the following functions to be controlled from a remote location:

- | | |
|-----------------------------------|------------------------------|
| ■ Ionization gauge IG1/IG2 on/off | ■ Pressure range selection |
| ■ Degas on/off | ■ Ionization gauge lockout |
| ■ Cathode select 1 or 2 | ■ Front panel switch disable |

In addition, the following functions are outputted in the form of relay contact closures which can signal the status of the instrument to a remote location, or control external devices.

- | | |
|---------------|---------------------------|
| ■ IG-1 on/off | ■ Degas on/off |
| ■ IG-2 on/off | ■ Circuit fault detection |

The optically isolated control inputs are on a 26 pin remote input connector. The relay contact outputs are accessible on the 15 pin remote output connector.

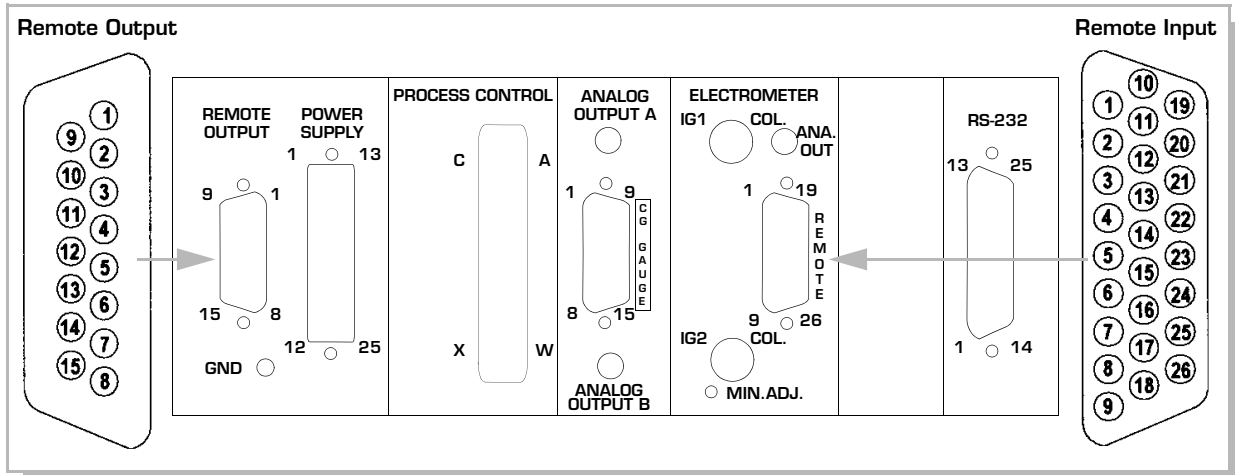

Figure 3-10 Control Unit Rear View Showing Locations of Remote Input and Output Connectors.

3.7.1 Definition of Input States

“Hi” = open circuit or TTL “1” state (to maximize noise immunity, pull up to +5 volts (pin 21)).

“Low” = closed circuit selection to option common or TTL “0” state.

Maximum current = 2 mA per low input.

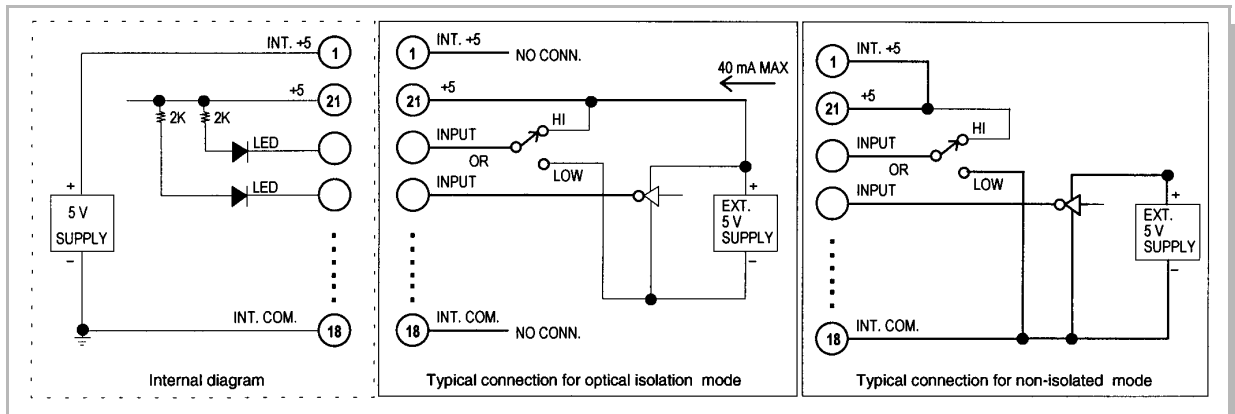

Figure 3-11 Remote Input Connections (Use DA-26P Connector, Supplied).

Table 3-2 Connections to DA-26P Connector.

Pin	Function
Remote Operation Inputs	
22	IG1 On/Off
9	IG2 On/Off
8	Degas On/Off
7	IG Lockout. Turns off IG and prevents turn on from any source.
25	Keyboard Disable. Prevents IG1, IG2, and degas buttons on front panel from functioning.
Remote Parameter Setup Inputs	
26	Remote Enable. Allows the backup cathode and range selection inputs to override the switches on the electrometer module's front panel. The next 4 input functions will have no effect unless this input is held low.
3	Backup Cathode IG1, selects backup cathode (Cathode 2) operation for IG1.
4	Backup Cathode IG2, selects backup cathode (Cathode 2) operation for IG2.
5	Pressure Range, IG1, selects pressure range (emission current) for IG1.
23	Pressure Range, IG2, selects pressure range (emission current) for IG2.
Power	
21	+5 V, optical isolator power: 5 V at 40 mA max.
1	Internal +5 V, access to non-isolated +5 V.
18	Internal Com., access to non-isolated ground.

3.7.2 Using the Remote Inputs

IG ON/OFF Inputs

(pins 22, 9): Either IG can be turned on by the remote inputs (if the pressure in the IG is adequately low, and the IG LOCKOUT input, Pin 7, is HI) by pulling the IG input line LOW after it has been HI for at least 35 msec. The input must then remain LOW until it is desired to turn the IG off.

Either IG can be turned off through the remote input by (1) switching the input HI after it has been low for at least 35 msec., or (2) by turning the other IG on as above, or (3) by pulling the IG lockout input, Pin 7, LOW.

NOTE: The state of this input does not override other IG-on and IG-off commands from the front panel buttons, the Convectron Gauge module, or the computer interface.

Degas ON/OFF Input (pin 8): Degas can be initiated by the remote inputs (if the IG is turned on, and it is measuring less than 5×10^{-5} Torr) by pulling the DEGAS input LOW after it has been HI for at least 35 msec. The input must remain LOW for the duration of the degas.

Degas can be terminated through the remote input by (1) switching the degas input HI after it has been LOW for at least 35 msec, or (2) turning off the IG. Degas can also be terminated by allowing the programmed time to expire.

NOTE: The state of the DEGAS input does not override other degas on/off commands from the front panel button, the computer interface, or the internal timer.

IG Lockout Input (pin 7): HI allows normal IG operation. LOW forces the IGs to turn off and positively stay off.

Keyboard Disable Input (pin 25): HI allows the front panel IG1, IG2, and DEGAS buttons to function normally. LOW prevents response from these buttons.

Remote Enable Input (pin 26): The inputs for selecting the pressure range and the backup cathode will take precedence over the computer interface commands as well as the switch settings on the Electrometer Module whenever this line is held LOW. When this line is open or HI, the remote parameter setup inputs will have no effect.

Backup Cathode Inputs (pins 3, 4): HI = cathode 1 selected. LOW = backup cathode 2 selected.

Pressure Range Inputs (pins 5, 23): HI = high pressure range using 100 μ A emission. LOW = low pressure range using 4 mA emission.

The **REMOTE LED** on the Electrometer module panel indicates parameter control status.

Table 3-3 REMOTE LED Status Indications.

LED Status	Pressure Range and Alternate Cathode are under Control of:
OFF	Panel toggle switches
ON	Remote inputs
FLASHING	Computer interface

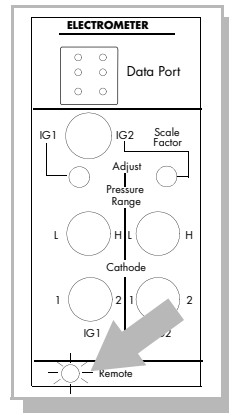

Figure 3-12 Electrometer Module Showing the Remote LED

3.7.3 Using the Remote Outputs

The relay contact outputs are accessible on the 15 pin remote output connector. These contacts provide status indication for IG1 and IG2 on or off, degas on or off, and fault detection. Figure 3-13 shows the pin designations. See Section 6.3 on page 6-4 for a description of fault relay indications.

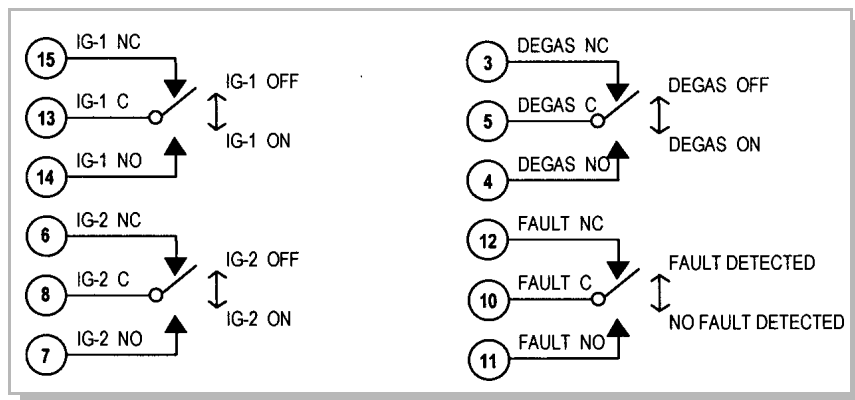

Figure 3-13 Remote Output Connector (Use DA-155 Mating Connectors, Supplied).

3.8 Connecting the RS-232 Computer Interface

Instructions for setting up this interface are in Section 2.1.5 on page 2-9.

The RS-232 computer interface produces the signals shown in Table 3-4.

A mating DB-25S connector is supplied in the hardware kit. Use shielded cable to minimize electromagnetic radiation or susceptibility. Ground the shield to the metal connector shell or to Pin 1. Do not connect the shield to Pin 7.

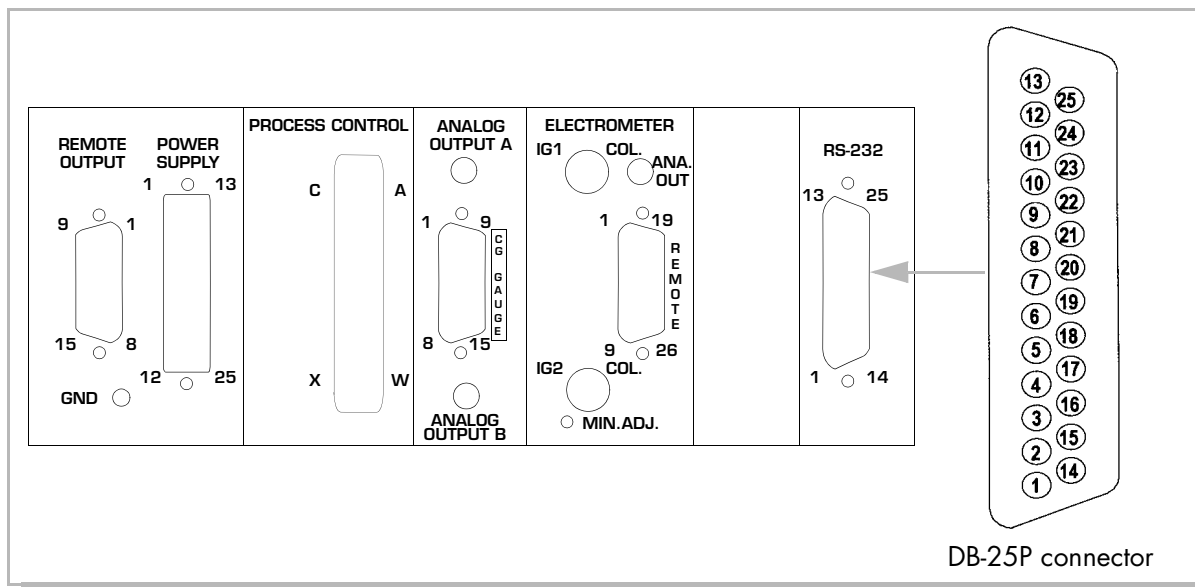

Figure 3-14 Control Unit Rear Panel Showing RS-232 Connector.

Table 3-4 RS-232 Connector Pin Assignments.

Signal	Pin Number	Direction
Protective Ground	1	–
Transmitted Data	2	To Computer
Received Data	3	To 360
Request to Send (RTS)	4	To Computer
Clear to Send (CTS)	5	To 360
Data Set Ready (DSR)	6	To 360
Signal Ground (common return)	7	–
Data Carrier Detect (DCD)	8	To 360
Data Terminal Ready (DTR)	20	To Computer

The DTR line is set true by the 360 Controller on power up to indicate it is on line. When the 360 receives a start bit on the received data line it will input and buffer a character. The DCD line must be true at the time each character is received or that character will be ignored. The 360 will continue to receive and buffer characters until the terminator (LF) is received.

Upon receiving the terminator, the 360 will assert the RTS line as a holdoff, to prevent the host computer from attempting to transmit further data until the message just received has been parsed and a reply has been output.

During output of the reply, the incoming handshake lines CTS, and DSR are tested prior to beginning transmission of each character. The 360 will wait until both are true before beginning transmission of a character, and will not test them again until ready to begin transmitting the next.

After transmitting the terminator, the 360 will negate RTS and wait for the next incoming message.

To summarize:

CTS, DSR

Set the computer to indicate that 360 may output the next byte in its message. As shipped from the factory these lines are forced "TRUE" by the switch settings of the 360 RS-232 printed circuit board. Thus the 360 will automatically assume the host is ready to receive. See Figure 2-16 on page 2-11 for the location of these switches.

DCD

Tested by the 360 when a character is received. The character will be ignored unless DCD is "TRUE". As shipped from the factory, this line is forced "TRUE" by the switch settings.

DTR

Always asserted by the 360. A "power on" indication.

RTS

Negated by the 360 on power-up. Asserted by the 360 upon receipt of a message terminator.
Negated after transmitting the terminator of the 360's response to that message.

RS-232 connections to a 9 pin connector on a Windows-based computer can be made by using a cable as shown in Table 3-5.

Table 3-5 Computer Cable Pin Assignments for a 9-Pin Connector.

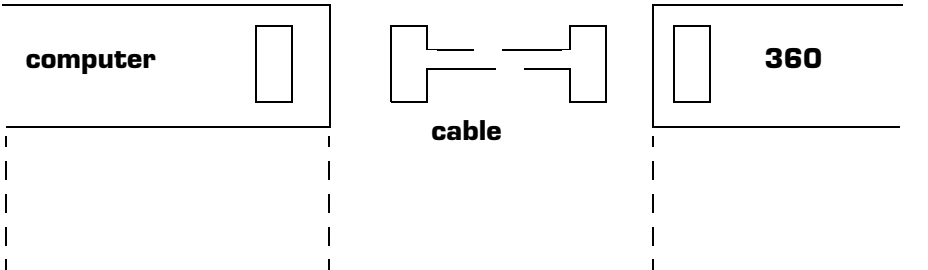

Signal	PC/AT Connector DE9P	Cable Pinout DE9S	DB25S	360 Connector DB25P
RXD	2	2	2	2
TXD	3	3	3	3
Signal Ground	5	5	7	7
CTS	8	8	4	4
RTS	7	7	5	5

If the computer has a 25 pin connector, use the configuration shown in Table 3-6.

Table 3-6 Computer Cable Pin Assignments for a 25-Pin Connector.

Signal	PC/AT Connector DB25P	Cable Pinout DE9S	DB25S	360 Connector DB25P
RXD	3	3	2	2
TXD	2	2	3	3
Signal Ground	7	7	7	7
CTS	5	5	4	4
RTS	4	4	5	5

Section 4.11 on page 4-25 contains instructions for communicating using the RS-232 Computer Interface.

3.9 Connecting the RS-485 Computer Interface

Instructions for setting up this interface are in Section 2.1.6 on page 2-12.

The RS-485 communications option permits data output to, and gauge control by, a host computer using RS-485 digital communications. Communications handshake is by a command-response mechanism.

Information on Commands begins in Section 4.12.1 on page 4-30.

Connectors J1 and J2, Figure 3-15, on the rear of the control unit are wired parallel and are interchangeable. Connection can be made by daisy chaining gauge controllers together with the signal from the host computer going into one connector, then out the other connector to another gauge controller.

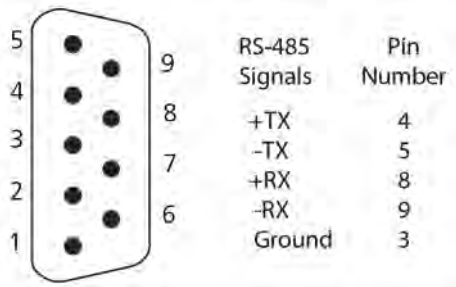

Figure 3-15 RS-485 Connector

The maximum total cable length is 4,000 ft. No more than 32 devices can be connected to one RS-485 communications line. When an RS-485 network is in an idle state, all nodes are in listen (receive) mode. Under this condition there are no active drivers on the network. In order to maintain the proper idle voltage state, bias resistors must be applied to force the data lines to the idle condition. Figure 3-16 illustrates the placement of bias resistors on a host computer, 2-wire configuration, for the typical 5 volt and 24 volt systems.

In a four wire configuration connect TX on the gauge controller to RX on the host computer and connect RX on the gauge controller to TX on the host computer. If the computer sends and receives data on 2 wires, connect the RS-485+ from the computer to both the +TX and +RX Pins (Pins 4 and 8), and connect the RS-485- from the computer to both -TX to -RX (Pins 5 and 9). Figure 3-17 shows the proper wire connections for a 2-wire connection.

When connecting multiple Series 360 Controllers connect TX to TX and RX to RX on all controllers.

The polarity may have to be reversed on the computer and other instruments—you may have to try it both ways. No damage will result if connections are wrong.

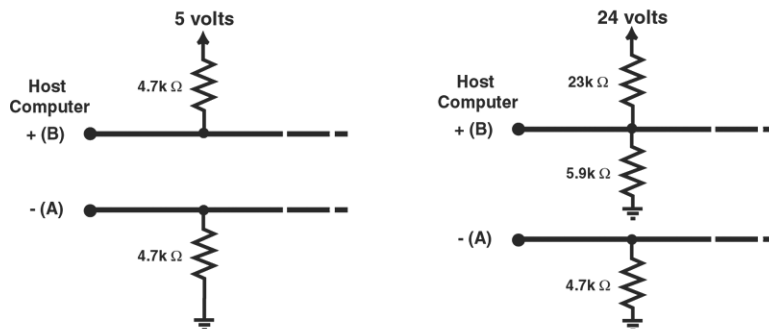

Figure 3-16 RS-485 Bias Resistor

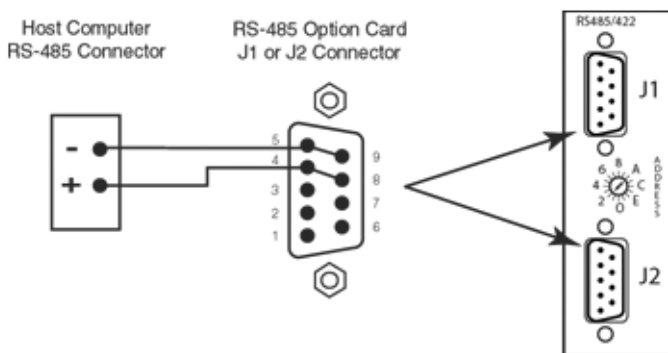

Figure 3-17 RS-485 Connectors

Table 3-7 RS-485 Specifications

Function	Specification
Communications Format	RS-485, half-duplex, asynchronous
Data Rate	9600 (Default), 4800, 2400, 1200, 600, 300, 150 baud
Character Length	8-bit or 7-bit ASCII (Factory default is 8-bit)
Parity	No parity, even or odd (Factory default is None)
Stop Bits	1 or 2 (Factory default is 1)
Handshake	None (Poll/Response)
Address	256 selectable combinations (Factory default is 01)
Number of Connections	Up to 32 devices
Total Cable Length	4,000 feet maximum
Connectors	Two 9-pin D-sub (Parallel)

3.10 Connecting the IEEE 488 Computer Interface

The IEEE 488 Computer Interface uses the industry standard 24 pin ribbon connector. (IEEE 488 Cables are available from Granville-Phillips.) Secure the mating connector from the bus using the captive screws. Instructions for setup of this interface are in Section 2.1.7 on page 2-15.

Instructions for communicating using this interface are in Section 4.13 on page 4-32.

3.11 Connecting the Gauge Cables



Be aware that an electrical discharge through a gas may couple dangerous high voltage directly to an ungrounded conductor almost as effectively as would a copper wire connection. A person may be seriously injured or even killed by merely touching an exposed ungrounded conductor at high potential.

This hazard is not unique to this product.



Be aware that when high voltage is present in any vacuum system, a life threatening electrical shock hazard may exist unless all exposed conductors are maintained at earth ground.

This hazard is not peculiar to this product.



All conductors in, on, or around the vacuum system that are exposed to potential high voltage electrical discharges must either be shielded at all times to protect personnel or must be connected to earth ground at all times.

1. Never touch the connector pins on any vacuum gauge if high voltages are present in the vacuum system. An electrical discharge or plasma may couple high voltage to the pins.
2. If you have Convector Gauge capability, connect a Convector Gauge cable between the Control Unit and each gauge.

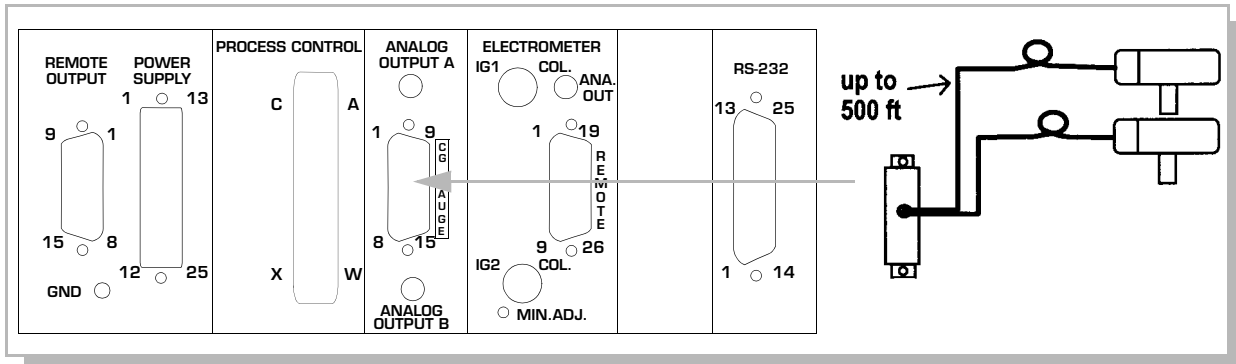



Figure 3-18 Control Unit Rear Panel Showing the Cable Connection to the Convector Gauges.



Warning - If used improperly, Convector Gauges can supply misleading pressure indications that can result in dangerous overpressure conditions within the system. For use with gases other than air or N₂, consult the gas type correction charts in Section 4.6.1 on page 4-12, or use a Memory Module programmed with data for the specific gas being used.

3. Connect the Stabil-Ion cable(s) to the Power Supply first before connecting them to either the gauges or the Control Unit.

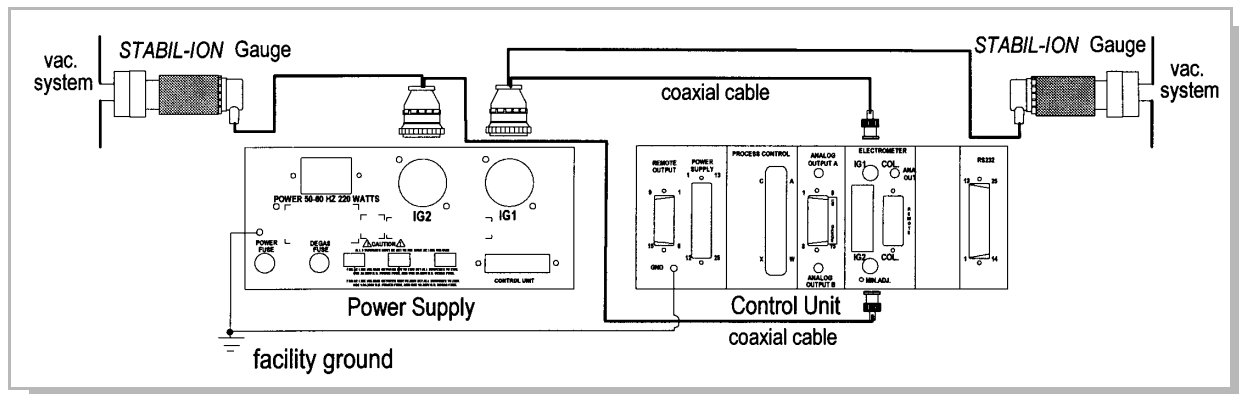

Figure 3-19 Power Supply and Control Unit Rear Views Showing the Cable Connections to the Stabil-Ion Gauges.

4. Connect the coaxial cable(s) to the corresponding connector on the Control Unit: IG1 to IG1, IG2 to IG2.
5. Connect the Stabil-Ion Gauge cable(s) to the Stabil-Ion Gauge(s) as follows:
 - a. Line up the locating notch on the connector locking ring with the matching ridge on the blue connector shell. See Figure 3-20.
 - b. Line up the cable connector with the gauge pin guard. The cable will exit in line with the locating key.
 - c. Insert the cable connector into the pin guard of the Stabil-Ion Gauge.
 - d. Rotate slightly until the locating key engages the cable connector keyway.
 - e. Push on the connector. Make sure the connector fully seats and the locking ring ears engage the pin guard ears.
 - f. Rotate the blue Guard clockwise until it stops against the detent. The cable is now locked to the Stabil-Ion Gauge.

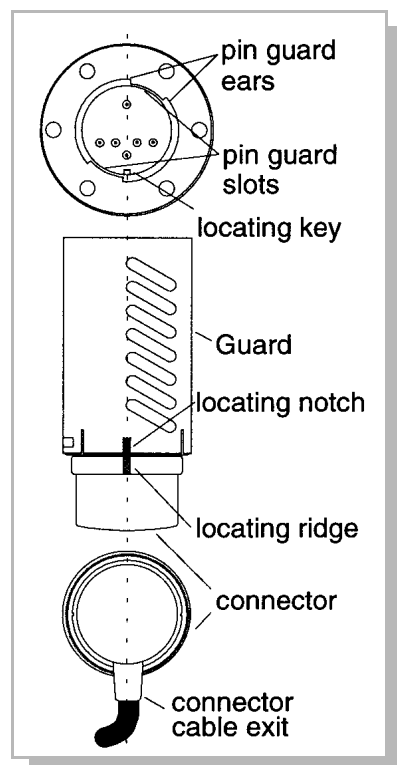



Figure 3-20 Stabil-Ion Gauge Connector Orientation (Prior to Installation).

The Guard is designed to shield gauge surfaces that can rise to above 100 °C. If the Guard must be removed, be sure that the gauge is not located where personnel performing necessary system operations might come in contact with the gauge envelope. The connector and cable assembly must be removed for system baking above 150 °C.

If space does not permit leaving the blue Guard attached to the cable connection during installation, separate the Guard from the cable connector, and install as follows:

- Grasp the Guard with your fingers.
- Place your thumb on the blue connector between two of the tabs on the connector end of the Guard.
- Carefully insert a small flat screwdriver blade under the tab and gently pry outward on one tab and then the other while forcing the blue connector sideways.
- The connector will pop out of the Guard. Use care not to permanently deform the tabs.
- Place the Guard on the Gauge.
- Complete steps "5a" through "5f", above, rotating the connector instead of the Guard in step "5f".
- Push the Guard back on the connector.

 **Do not touch the Stabil-Ion Gauge during degas operation if the Guard has been removed. Serious burns can occur.**

6. To remove the connector from the Stabil-Ion Gauge, rotate the blue Guard counterclockwise about 20° until it hits the stop. Pull the connector straight back from the gauge.
7. Clamp the gauge cables in a fixed position throughout their length to provide strain relief at the connectors and to prevent undesirable effects on performance that might be caused by cable movement.

 **Danger, high voltage – 180V is present in the Power Supply, on the cable, and at the ion gauge when the gauge is turned on. Voltages as high as 850V peak are present during degas.**

Do not operate in an explosive atmosphere.

Do not operate the product in the presence of flammable gases or fumes.

Operation of any electrical instrument in such an environment constitutes a definite safety hazard.

 **Do not use the product to measure the pressure of explosive or combustible gases or gas mixtures. Ionization gauge cathodes operate at high temperatures. The sensor wire of the Convectron Gauges normally operates at only 125°C, but it is possible that Control Unit malfunction can raise the sensor temperature above the ignition temperature of combustible mixtures.**

Danger of explosion or inadvertent venting to atmosphere exists on all vacuum systems which incorporate gas sources or involve processes capable of pressurizing the system above safe limits.

 **Operation of the product with line voltage other than that selected by the proper power supply switches can cause damage to the instrument and injury to personnel.**

3.12 Connecting the Power Cables

1. After completing the set up, connect the interconnect cable to the Control Unit and to the Power Supply. A 0.6 m (2 ft) [or a 3 m (10 ft) for remote mounting] interconnect cable is supplied with your Controller and has identical 25 pin connectors at both ends. Secure the ends at the Power Supply connector and the Control Unit connector using the two captive screws on each connector.

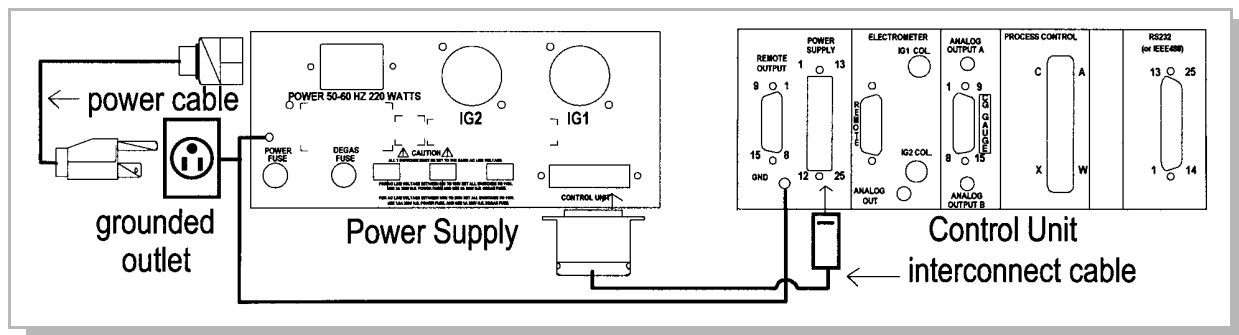

Figure 3-21 Power Supply and Control Unit Rear Views Showing Power Cable Connections.



Compliance with the usual warning to connect the power cable only to a properly grounded outlet is necessary but not sufficient for safe operation of a vacuum system with this or any similar high voltage producing product. Grounding this product does not and cannot guarantee that other components of the vacuum system are all maintained at earth ground.



It is the installer's responsibility to ensure that the automatic signals provided by the product are always used in a safe manner. Carefully check the system using manual operation and the setpoint programming before switching to automatic operation.



Where an equipment malfunction could cause a hazardous situation, always provide for fail-safe operation. As an example, in an automatic backfill operation where a malfunction might cause high internal pressures, provide an appropriate pressure relief device.



Installation and wiring must be in compliance with your local building and electrical codes. CONNECT THE POWER CORD ONLY TO A PROPERLY GROUNDED OUTLET.



Primary Mains disconnect is provided by the A.C. Power Cord. Install unit so there is access to the A.C. Power Cord.

2. Verify that the line voltage switches are set properly. See Section 2.2 on page 2-17.
3. Connect the power cable to a grounded outlet.
4. Assuming you have completed the set up and installation according to the foregoing instructions, the Stabil-Ion System should now be ready to turn on and operate. If you are using the Process Control Option, you must prepare for process control operation before turning on the 360 in automatic mode. See Section 4.10 on page 4-24. Attempting automatic operation with process control before the controls are properly set can cause costly damage and even be dangerous.

Preparing the Stabil-Ion System for Operation

4.1 Preparing for Pressure Measurement with the Stabil-Ion Gauge¹

1. The steps in this Section (4.1) assume:
 - a. Your Stabil-Ion System has been properly set up and installed per the instructions in Chapters 2 and 3.
 - b. The gas in your vacuum system is air or N₂. For other gases you must follow the instructions in Section 4.1.3 on page 4-5 for using Stabil-Ion Gauges and in Section 4.6.1 on page 4-12 for using Convectron Gauges.
 - c. That you are reasonably familiar with the general theory of operation of hot cathode ionization gauges and thermal conductivity gauges.

We recommend you consult a good text book if you are unfamiliar with vacuum technology or require more information on the general theory of operation of an ionization gauge or thermal conductivity gauge. Extremely useful information is provided in the following references.

- Dushman, S., Lafferty, J. M., *Scientific Foundations of Vacuum Technique*, John Wiley & Sons, Inc., Second Edition, New York, 1962.
 - Redhead, P. A., et al., *Ultrahigh Vacuum*, Chapman and Hall, London, 1968.
 - O'Hanlon, J. F., *A User's Guide to Vacuum Technology*, John Wiley & Sons, New York, 1980.
2. Turn on the Stabil-Ion System by pressing the Control Unit power switch labeled ON. See Figure 4-1.
 3. Convectron Gauge equivalent N₂ pressures will be displayed whenever power is applied if the gauges and cables are installed. Make sure the IG1 AUTO and IG2 AUTO switches are in the IG AUTO ON or OFF position and have not been left in the set positions. See Section 4.6 on page 4-11 for information on Convectron Gauge pressure measurement.
 4. Open the front door of the Control Unit and make the following settings on the electrometer module for each Stabil-Ion Gauge channel.

1. For completeness, all available capabilities are assumed present. Not all capabilities may be present in the product you have specified.

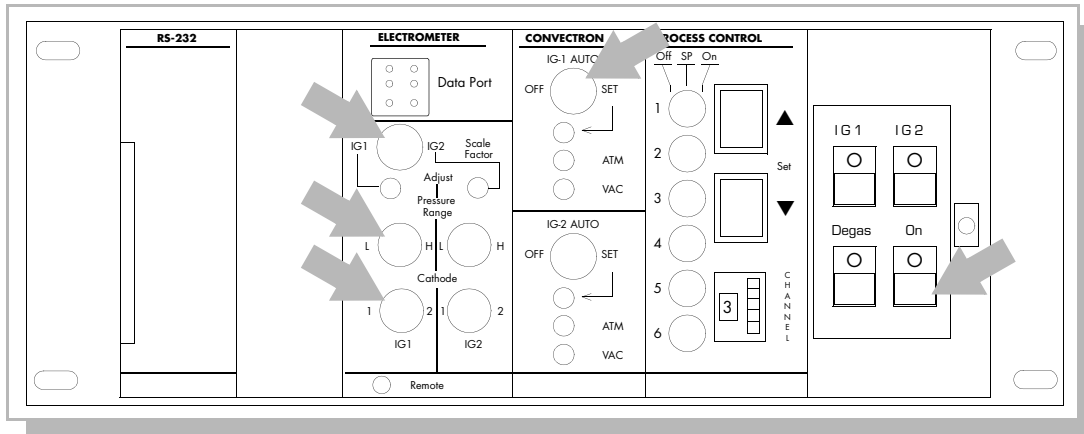

Figure 4-1 Control Unit (with Door Open) Showing Electrometer Module Controls.

- a. **SCALE FACTOR:** Assuming the gas in the system is air or N_2 , adjust IG1 and IG2 scale factors to 1.00 with the scale factor switch set in the respective positions. Then set the scale factor switch at OFF. See Section 4.1.2 on page 4-4 for other gases.
- b. **CATHODE:** Set at **1** for primary cathode (set at **2** for alternate cathode if required). Separate switches are provided for IG1 and IG2.
- c. **PRESSURE RANGE:** Select **H** or **L**. Separate switches are provided for IG1 and IG2.

The **H** range is preferred for applications involving pressure measurement above 1×10^{-4} Torr. The emission current and cathode power are reduced and the upper pressure limit and overpressure IG shut down setpoint are extended. The **H** range provides increased cathode life when the IG is operated at higher pressures.

The **L** range is preferred for applications involving pressure measurement below approximately 1×10^{-7} Torr. It provides the fastest response to pressures below 1×10^{-7} Torr and allows measurement to the x-ray limit of the Stabil-Ion Gauge.

Whether **H** or **L** is preferred between 10^{-4} and 10^{-7} Torr depends on whether the expected pressures will be above 10^{-4} Torr or below 10^{-7} Torr.

The Stabil-Ion Gauge will provide the best stability and lifetime when the pressure range selector switch is set as shown in Table 4-1.

Table 4-1 Optimum Pressure Range Settings for N₂.

Switch Setting	Pressure Extreme (Torr)	Emission	Overpressure Setpoint
H - High Range	above 10 ⁻⁴	0.1 mA	2×10 ⁻² Torr, or mbar; 2 Pa
L - Low Range	below 10 ⁻⁷	4 mA	5×10 ⁻⁴ Torr, or mbar; 5 × 10 ⁻² Pa

For example, if pressures in your application will range from 1 × 10⁻² to say 5 × 10⁻⁸ Torr, leave the range switch on **H**. If much of the time the system pressure will be below approximately 1 × 10⁻⁴ Torr, leave the switch on **L**. We suggest you do not change the range switch frequently because there is a significant stabilization time to obtain steady state conditions.

*NOTE: When the cathode is first turned on, or has been exposed to atmospheric pressure, it is normal for a relatively large burst of gas to be released momentarily. Using the **H** range will help prevent a nuisance shutdown from this burst.*

5. When the pressure in the vicinity of IG1 is less than the overpressure setpoint listed above, as indicated by a Convectron Gauge or another gauge, turn on IG1. See Section 4.7 on page 4-21 for automatic operation.
6. The N₂ equivalent pressure within IG1 will be displayed in the pressure units you have specified (Torr, mbar or Pa). See Section 2.1.3 on page 2-4 to change pressure units.
7. Steps 5 and 6 also apply for IG2 if your Stabil-Ion System is equipped with the Dual Stabil-Ion Operation module.

4.1.1 Alternate ON/OFF Gauge Control

The Stabil-Ion Gauges may be turned on and off in 4 ways:

- Using the front panel push buttons, IG1 and IG2.
- Remotely with the available Remote Control module, see Section 3.7 on page 3-9.
- Automatically using the auto on function of the Convectron Gauge module. See Section 4.7 on page 4-21.
- Using the RS-232, RS-485, or IEEE 488 Computer Interface modules. See Section 4.11 on page 4-25, Section 4.12 on page 4-29, or Section 4.13 on page 4-32.

In addition, the Stabil-Ion Gauge will be automatically turned off by excessive pressure.

4.1.2 Gas Scale Factor Adjustment

If highly accurate pressure measurement of gases is required, we recommend calibration for the specific gas and system to be used. See Section 4.4 on page 4-8. The standard calibration is for N₂. Different gases have different ionization probabilities. If a Stabil-Ion Gauge and Controller are calibrated for N₂, and if argon is the predominant gas in the system, setting the scale factor at 7.75×10^{-1} as shown in Table 4-2 on page 4-5 causes the pressure indications for N₂ to be multiplied by 0.775, thus providing correct pressure indications for argon over most of the pressure range. At pressures above about 1×10^{-5} Torr this method may not provide accurate pressure indications.

For additional information on ionization probabilities, refer to: NASA Technical Note TND5285, "Ionization Gauge Sensitivities as Reported in the Literature," by Robert L. Summers, Lewis Research Center, National Aeronautics and Space Administration.

To prepare for measuring the pressure of gases other than air or N₂ with IG1 or IG2, proceed as follows:

1. Turn off IG1 and IG2.
2. Open the front panel door and set the scale factor switch to IG1 (or IG2).
3. The current scale factor setting for IG1 (or IG2) will be displayed on the first line of the display if neither Stabil-Ion Gauge is on.

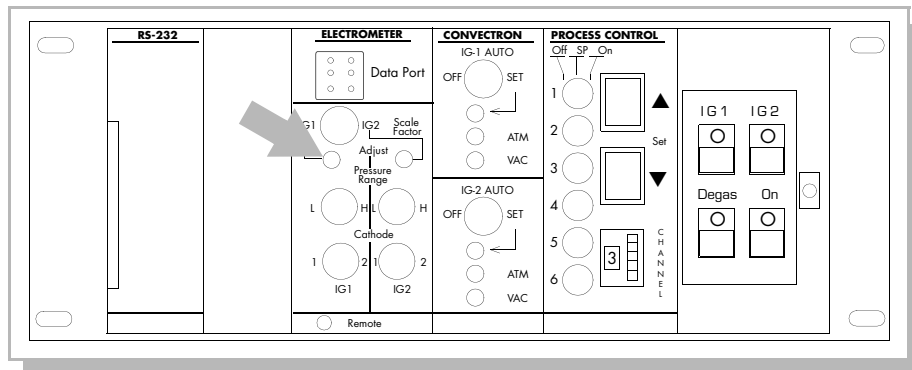

Figure 4-2 Control Unit Front Panel (with Door Open) Showing Scale Factor Display Switch.

4. Set the scale factor adjustment to the appropriate factor listed in Table 4-2.
5. Return the scale factor switch to the center position.
6. Repeat steps 3, 4, and 5 for IG2. IG2 may be set for a different gas than IG1.

Table 4-2 Scale Factors for Use with Ionization Gauges.**(Do not use these scale factors for CONVECTRON Gauges)**

Gas	Scale Factor	Gas	Scale Factor
He	5.56	H ₂ O	8.93×10^{-1}
Ne	3.33	NO	8.62×10^{-1}
D ₂	2.86	Ar	7.75×10^{-1}
H ₂	2.17	CO ₂	7.04×10^{-1}
N ₂	1.00	Kr	5.15×10^{-1}
Air	1.00	SF	4.00×10^{-1}
O ₂	9.90×10^{-1}	Xe	3.48×10^{-1}
CO	9.52×10^{-1}	Hg	2.75×10^{-1}

If the Stabil-Ion Gauge calibration is for a gas type other than N₂ (or air), we suggest placing a label near the first line of the display indicating the gas type or types used for calibration to prevent mix-ups.

4.1.3 Overpressure Shutdown.

This control is factory set so the ion gauge will shut down when the pressure rises above the overpressure setpoint pressures shown in Table 4-1. See Section 6.4 on page 6-5 if you want to change the overpressure setpoint.

4.2 Degassing the Stabil-Ion Gauge



Danger, high voltage – 180V is present in the Power Supply, on the cable, and at the ion gauge when the gauge is turned on. Voltages as high as 850V peak are present during degas.



Be aware that an electrical discharge through a gas may couple dangerous high voltage directly to an ungrounded conductor almost as effectively as would a copper wire connection. A person may be seriously injured or even killed by merely touching an exposed ungrounded conductor at high potential.

This hazard is not unique to this product.





Be aware that when high voltage is present in any vacuum system, a life threatening electrical shock hazard may exist unless all exposed conductors are maintained at earth ground.

This hazard is not peculiar to this product.

- 

All conductors in, on, or around the vacuum system that are exposed to potential high voltage electrical discharges must either be shielded at all times to protect personnel or must be connected to earth ground at all times.
- 

Compliance with the usual warning to connect the power cable only to a properly grounded outlet is necessary but not sufficient for safe operation of a vacuum system with this or any similar high voltage producing product. Grounding this product does not and cannot guarantee that other components of the vacuum system are all maintained at earth ground.
- 

Finite Lifetime - After ten years of normal use or even non-use, the electrical insulation in this product may become less effective at preventing electrical shock. Under certain environmental conditions which are beyond the manufacturer's control, some insulation material may deteriorate sooner. Therefore, periodically inspect all electrical insulation for cracks, crazing, or other signs of deterioration. Do not use if the electrical insulation has become unsafe.
- 

Do not touch the Stabil-Ion Gauge during degas operation if the Guard is removed. Serious burns can occur.

The 360 Stabil-Ion System employs electron bombardment (EB) degassing of gauge electrodes, which is the most direct and efficient means to remove contaminants. High energy electrons striking the anode heat the anode and help remove any foreign materials while the increased cathode power cleans the cathode surface effectively. Of course, it is necessary to pump the contaminants from the gauge during degas. A system pressure below 10^{-5} Torr is required to accomplish this effectively. Measurements below about 10^{-8} Torr require degassing in the 10^{-6} Torr range and again as the system approaches the ultimate pressure.

Degas cannot be activated unless the Stabil-Ion Gauge pressure indication is below 5×10^{-5} Torr (6.6×10^{-5} mbar, or 6.6×10^{-3} Pa) in the High pressure range, or below 1.2×10^{-6} Torr (1.6×10^{-6} mbar, or 1.6×10^{-4} Pa) in the Low pressure range. Degassing above this pressure is of little value and may cause pressure bursts that can cause an electrical gas discharge which can couple high voltage to the vacuum system hardware, shut down the Stabil-Ion Gauge, and in some cases cause damage—or create a shock hazard unless the system is properly grounded.

Degas power may be turned on or off in three ways:

- Using the front panel degas push-button.
- Via the Remote Control input. See Section 3.7 on page 3-9.
- Using an RS-232, RS-485, or IEEE 488 Computer Interface module. See Section 4.11 on page 4-25, Section 4.12 on page 4-29, or Section 4.13 on page 4-32.

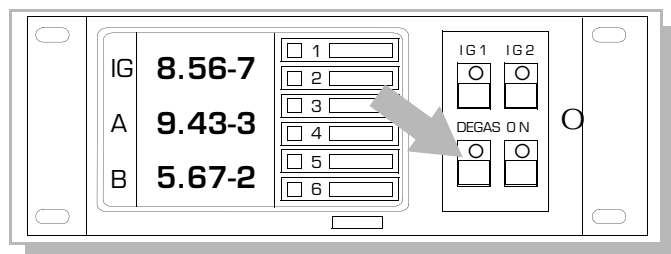

Figure 4-3 Control Unit Front Panel Showing Degas Button.

4.2.1 Pressure Indication During Degas

An approximate indication of pressure within the Stabil-Ion Gauge is provided on the digital display during degas. Observing this pressure indication rise, peak out and then fall is an excellent means of determining the optimum time of degas. The indication may eventually be unrealistically low due to a reverse x-ray current effect or temporary gauge pumping. Degassing purposely changes surface conditions in the gauge. After degassing, permit sufficient time for steady state conditions to be established before attempting to make measurements.

4.2.2 Degas Timer

The degas timer is factory preset for 10 minutes. See Section 2.1.8 on page 2-16 to change this time.

4.2.3 Degas Limiter

For convenience and improved safety, degas power is automatically reduced as gas is liberated to prevent excessive pressure rise and help reduce the possibility of a gas discharge forming. As the electrodes clean up, power is increased to a maximum of 40 W. This feature limits the maximum pressure indication to about 5×10^{-5} Torr during degas.

4.2.4 Gauge Bakeout

Applying an external heat source to the vacuum system and to the gauge envelope can speed the removal of contamination from the interior surfaces. Bakeout temperatures between 150 °C and 300 °C are typically adequate. Do not exceed 450 °C at the Stabil-Ion Gauge envelope. Do not exceed 150 °C at the cable and connector.

4.3 Alternate Cathode Operation

The cathode coating used in the Stabil-Ion Gauge to provide electron emission at relatively low cathode temperatures has a finite operating life—typically two to three years at low pressure. Ion bombardment at higher pressures tends to erode the coating faster than at lower pressures. Stabil-Ion Gauges have a second independent cathode for use when the first cathode finally tires and does not emit sufficiently. The Controller will automatically turn the IG off if the cathode has insufficient emission either due to contamination of the cathode or long use.

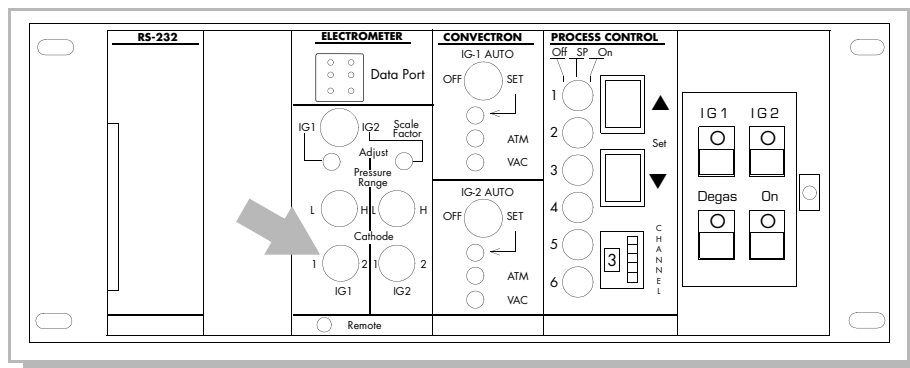

Figure 4-4 Control Unit Front Panel (with Door Open) Showing Alternate Cathode Switch.

4.4 Stabil-Ion Gauge Calibration Memory

The Stabil-Ion Gauge is the first ionization gauge with sufficient long term stability to justify storing calibration data in memory. The calibration data is stored in a nonvolatile memory in the electrometer module. Granville-Phillips calibration data for N₂ is averaged over a number of nominally identical Stabil-Ion Gauges and programmed in memory (Standard Calibration). All Stabil-Ion Systems are supplied with this feature. This is indicated by a sequence of 001, 002 in the top display line after the initial powerup.

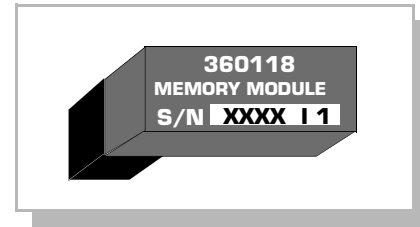

Figure 4-5 Calibration Memory Module.

If the Stabil-Ion Gauge calibration is for a gas type other than N₂ (or air), we suggest placing a label near the first line of the display indicating the gas type or types used for calibration to prevent mix-ups.

4.4.1 Memory Modules for Stabil-Ion Gauge

IG1 and IG2 data is stored independently and must be loaded from separate Memory Modules. Each module contains data for both cathodes in a Stabil-Ion Gauge.

New data for each gauge can be transferred to the internal memory using a Memory Module which has been programmed by Granville-Phillips. The IG destination for the data contained in the Memory Module is predetermined at the time it is programmed and is stored along with the data. The data is individually serialized, and the serial number is printed on the module's label as well as being stored electronically in the memory.

When the Dual Stabil-Ion Gauge option is not installed in the Power Supply (as evidenced by only one IG connector on the rear panel of the Power Supply), two separate Memory Modules can be used for IG1 by selecting either IG1 or IG2 for gauge operation. If you wish to use this special capability of the 360, we recommend that you contact the factory for further explanation.

4.4.2 Using a Memory Module for IG1 or IG2



Protect the Memory Module from static electricity. Touch a grounded, unpainted metal surface on the 360 Control Unit and then touch the surface of the anti-static bag before removing the Memory Module from its bag.

1. Turn off power.
2. Open front panel door.
3. Using a high impedance grounding wrist strap or other effective antistatic protection, remove the Memory Module from its antistatic packaging. Save the antistatic packaging.
4. Plug the Memory Module into the data port with the writing on the module label right-side-up.
5. Turn on power. Within 5 seconds the data in the Memory Module will transfer to main memory.
6. The last 3 digits of the Memory Module identification numbers will be displayed for a few seconds and thereafter for a few seconds each time the Stabil-Ion System power is turned on. If two Memory Modules are utilized, two numbers will be displayed in sequence in the top display—the first for IG1, the second for IG2. If the memory contains standard factory supplied data, the serial number of that data, when displayed, will begin with 0.

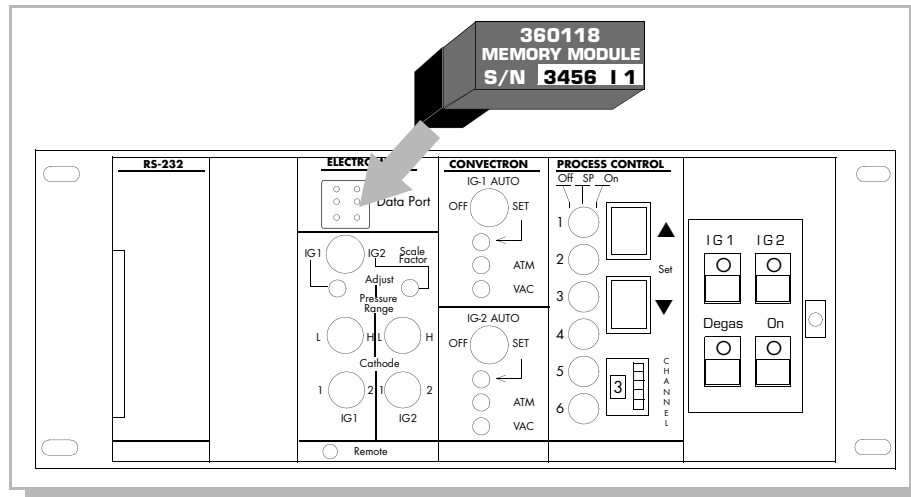

Figure 4-6 Control Unit Front Panel (with Door Open) Showing Memory Module Location.

7. If the Memory Module contains Stabil-Ion Gauge calibration data for the same gas type as is predominately present in the system, set the scale factor on the electrometer to 1.00.

If the Memory Module contains Stabil-Ion Gauge calibration data for N_2 and the gas in the system is predominately of type X, set the scale factor at the appropriate value for gas type X. See Section 4.1.2 on page 4-4.

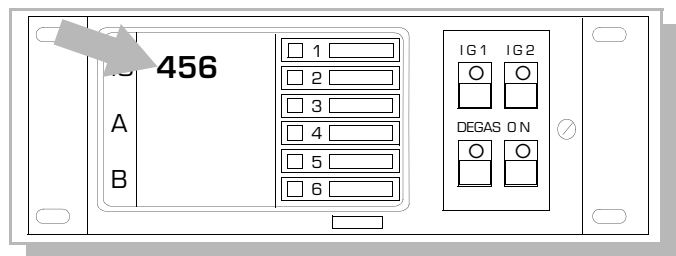

Figure 4-7 Control Unit Front Panel Display Showing Last Three Digits of Memory Module Identification.

8. Turn off power and, using antistatic protection, unplug the Memory Module and return it to its antistatic packaging.
9. Save the Memory Module together with the original calibration data, all properly identified, for possible later use.

4.5 Stabil-Ion Gauge Analog Output Signal

A signal voltage proportional to the logarithm of the Stabil-Ion Gauge pressure indication is provided on the back of the electrometer module via a standard 1/8 in. miniature phone jack.

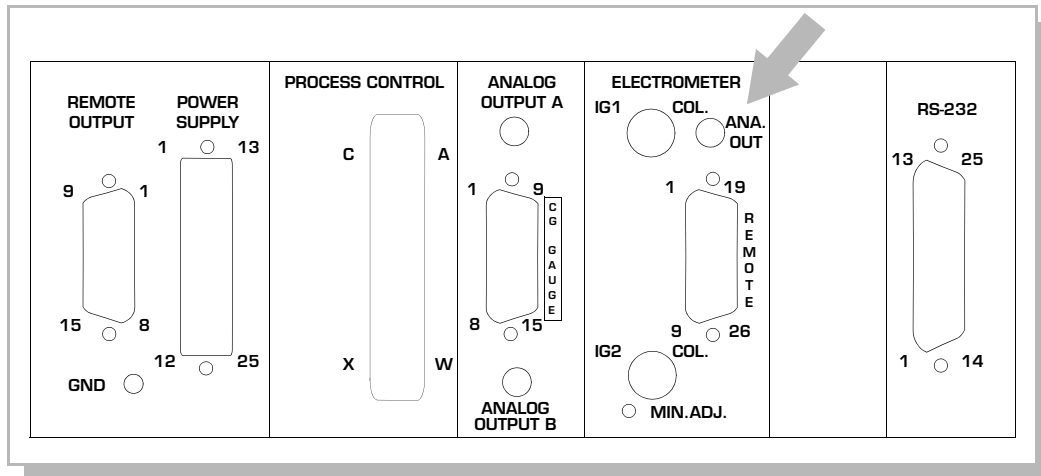

Figure 4-8 Control Unit Rear Panel Showing Location of IG Analog Output.

Normal Measurement Operation

$$\begin{aligned} \text{Pressure indication, } P_i &= 10^{V-11} \text{ Torr or mbar} \\ &= 10^{V-9} \text{ Pascal} \end{aligned}$$

When Degassing

$$\begin{aligned} \text{Pressure indication, } P_i &= 10^{V-13.92} \text{ Torr or mbar} \\ &= 10^{V-11.92} \text{ Pascal} \end{aligned}$$

When gauge is off, V is > 10 volts

This signal voltage is determined by the pressure indicated on the IG display. Thus if the scale-factor is set correctly for a given gas as specified in Section 4.1.2 on page 4-4, the equations above and curves in Figure 4-9 on page 4-11 still apply for the given gas.

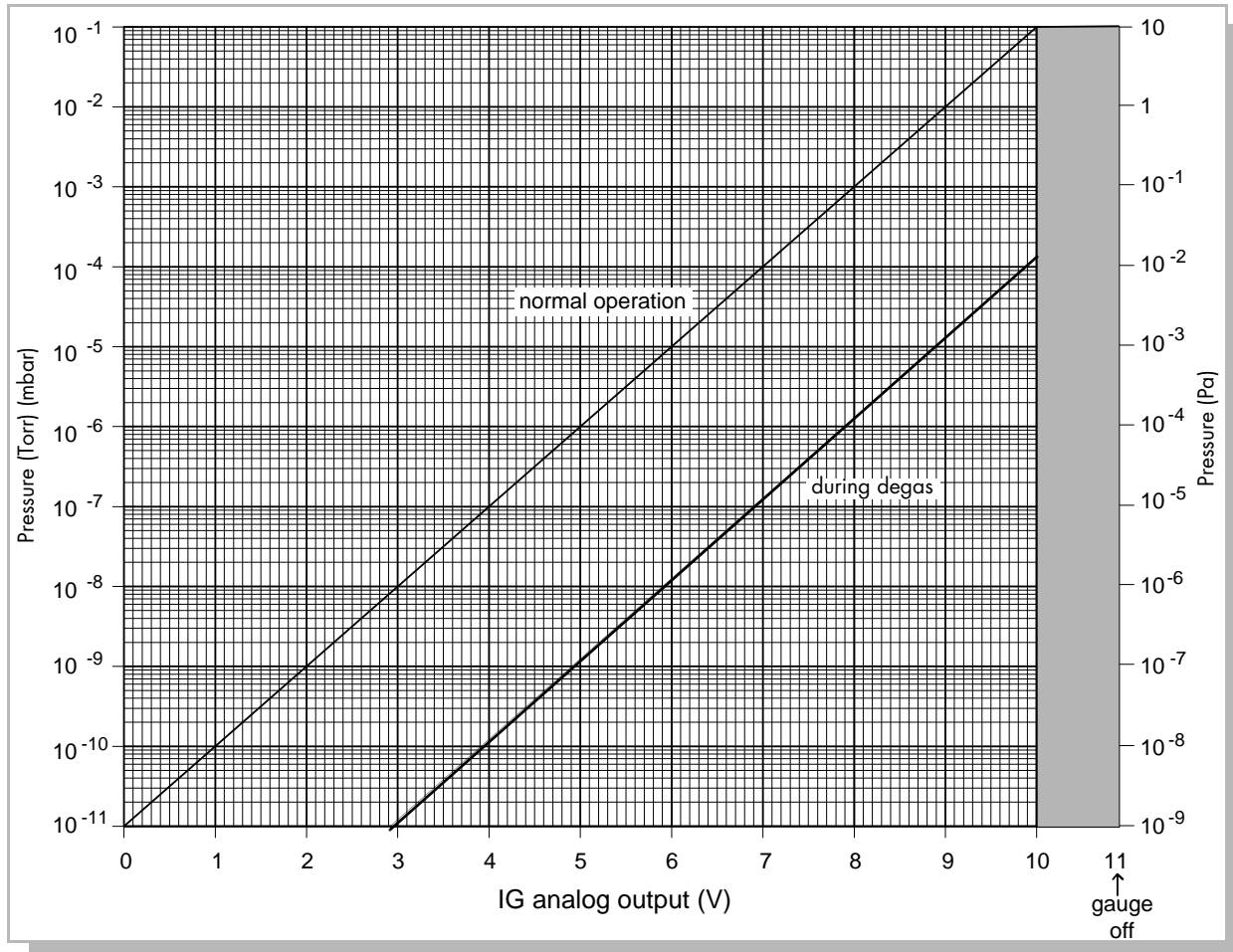

Figure 4-9 Ionization Gauge Analog Output vs. Pressure.

4.6 Preparing for Convectron Gauge Operation

Convectron Gauge pressures are indicated on lines A and B of the 360 Controller display.



Using the N₂ calibration to pressurize a vacuum system above about 1 Torr with certain other gases can cause dangerously high pressures which may cause explosion of the system. See Section 4.6.1 on page 4-12 before using with other gases.

Install suitable devices that will limit the pressure to the level that the vacuum system can safely withstand. In addition, install suitable pressure relief valves or rupture disks that will release pressure at a level considerably below that pressure which the system can safely withstand.

Suppliers of pressure relief valves and pressure relief disks are listed in the Thomas Register under “Valves, Relief”, and “Discs, Rupture”.

Confirm that these safety devices are properly installed before installing the product. In addition, check that (1) the proper gas cylinders are installed, (2) gas cylinder valve positions are correct on manual systems, and (3) the automation is correct on automated systems.

Vacuum gauges with compression fittings may be forcefully ejected if the vacuum system is pressurized.

4.6.1 Understanding Pressure Measurement in Gases other than Nitrogen (or Air)

Convectron Gauges are thermal conductivity gauges of the Pirani type. These gauges transduce gas pressure by measuring the heat loss from a heated sensor wire maintained at constant temperature. For different gases, the heat loss is different at any given true pressure and thus the pressure indication can be very different.

It is important to understand that the indicated pressure of a Convectron Gauge depends on the type of gas, the orientation of the gauge axis, and on the gas density in the gauge. Convectron Gauges are normally supplied calibrated for N₂ (air has approximately the same calibration). With proper precautions, the Convectron Gauge may be used to measure pressure of certain other gases.

The following information in this section applies only when the Convectron Gauge has been calibrated for N₂ with the standard factory memory data, and when the Convectron Gauge is mounted with its axis horizontal.

At pressures below a few Torr, there is no danger in measuring pressure of gases other than N₂ and air, merely inaccurate indications. A danger arises if the N₂ calibration is used without correction to measure higher pressures of some other gases. For example, N₂ or air at 24 Torr causes the same heat loss from the Convectron sensor as will argon at atmospheric pressure. Thus if the pressure indication of the Convectron Gauge is not properly corrected for argon, an operator attempting to fill a vacuum system with 1/2 atmosphere of argon would observe an indication of only 12 Torr when the actual pressure had risen to the desired 380 Torr. Continuing to fill the system with argon to 760 Torr would result in only a 24 Torr indication. Depending on the pressure of the argon gas source, the chamber could be dangerously pressurized while the display continued to read about 30 Torr of N₂ equivalent pressure.

NOTE: The same type of danger likely exists with other thermal conductivity gauges utilizing convection to extend the range to high pressures; and with Convectron Gauges calibrated for gas type Y when used with gas type X.

Understand that, with a Convectron Gauge calibrated for N₂, to measure the pressure of gases other than N₂ and air you must use the conversion curves specifically for the Convectron Gauge to translate between indicated pressure and true pressure. Do not use other data. Never use conversion curves for the Convectron Gauge with gauges of other manufacturers. Their geometry is very likely different and dangerously high pressures may be produced even at relatively low pressure indications. **Also, you must ensure that the atmosphere adjustments for Convectron Gauges A and B are correctly set. See Section 4.8 on page 4-22.**

Figures 4-10 through 4-15 show the true pressure vs. indicated pressure for eleven commonly used gases. The following list will help to locate the proper graph:

Table 4-3 Pressure vs. Indicated N_2 Pressure Curve.

Fig. No.	Pressure Range and Units	Gases
4-10	10^{-4} to 10^{-1} Torr	All
4-11	10^{-1} to 1000 Torr	Ar, CO_2 , CH_4 , Freon 12, He
4-12	10^{-1} to 1000 Torr	D_2 , Freon 22, Kr, Ne, O_2
4-13	10^{-4} to 10^{-1} mbar	All
4-14	10^{-1} to 1000 mbar	Ar, CO_2 , CH_4 , Freon 12, He
4-15	10^{-1} to 1000 mbar	D_2 , Freon 22, Kr, He, O_2

Note that 1 mbar = 100 Pa, so the mbar charts may be used for pascal units by multiplying the values on the axes by 100.

A useful interpretation of these curves is, for example, that at a true pressure of 2×10^{-2} Torr of CH_4 the heat loss from the sensor is the same as at a true pressure of 3×10^{-2} of N_2 (see Figure 4-10). The curves at higher pressure vary widely from gas to gas because the thermal losses at higher pressures are greatly different for different gases.

If you must measure the pressure of gases other than N_2 or air, use Figures 4-10 through 4-15 to determine the maximum safe indicated pressure for the other gas as explained below.

4.6.2 Examples

Example 1 – Maximum safe indicated pressure.

Assume a certain system will withstand an internal pressure of 2000 Torr or 38.7 psia. For safety, you wish to limit the maximum internal pressure to 760 Torr during backfilling. Assume you wish to measure the pressure of Freon 22. On Figure 4-12, locate 760 Torr on the left hand scale, travel to the right to the intersection with the Freon 22 curve, and then down to an indicated pressure of 11 Torr (N_2 equivalent). Thus, in this hypothetical situation, the maximum safe indicated pressure for Freon 22 is 11 Torr.

For the sake of safety, it is prudent to place a warning label on the instrument face which under the assumed conditions would read "DO NOT EXCEED 11 TORR FOR FREON 22".

If the Convectron Gauge calibration is for a gas type other than N_2 (or air), we suggest placing a label near the second and third lines of the display indicating the gas type or types used for calibration to prevent mix-ups.

Example 2 – *Indicated to true pressure conversion.*

Assume you wish to determine the true pressure of helium in a system when the Convectron is indicating 10 Torr. On Figure 4-11, read up from 10 Torr (N₂ equivalent) indicated pressure to the Helium curve and then horizontally to the left to a true pressure of 4.5 Torr. Thus 4.5 Torr Helium pressure produces an indication of 10 Torr (N₂ equivalent).

Example 3 – *True to indicated pressure conversion.*

Assume you wish to set a process control setpoint at a true pressure of 20 Torr of CO₂. On Figure 4-11 on page 4-16, locate 20 Torr on the true pressure scale, travel horizontally to the right to the CO₂ curve and then down to an indicated pressure of 6.4 Torr (N₂ equivalent). Thus the correct process control setting for 20 Torr of CO₂ is 6.4 Torr (N₂ equivalent).

Example 4 – *True to indicated pressure conversion.*

Assume you wish to obtain a helium pressure of 100 Torr in the system. On Figure 4-11, locate 100 Torr on the left hand scale, travel horizontally to the right to attempt to intersect the He curve. Because the intersection is off scale, it is apparent that this true pressure measurement requirement for helium exceeds the capability of the instrument.

For gases other than those listed, the user must provide accurate conversion data for safe operation. The Convectron Gauge is not intended for use above approximately 1000 Torr true pressure.

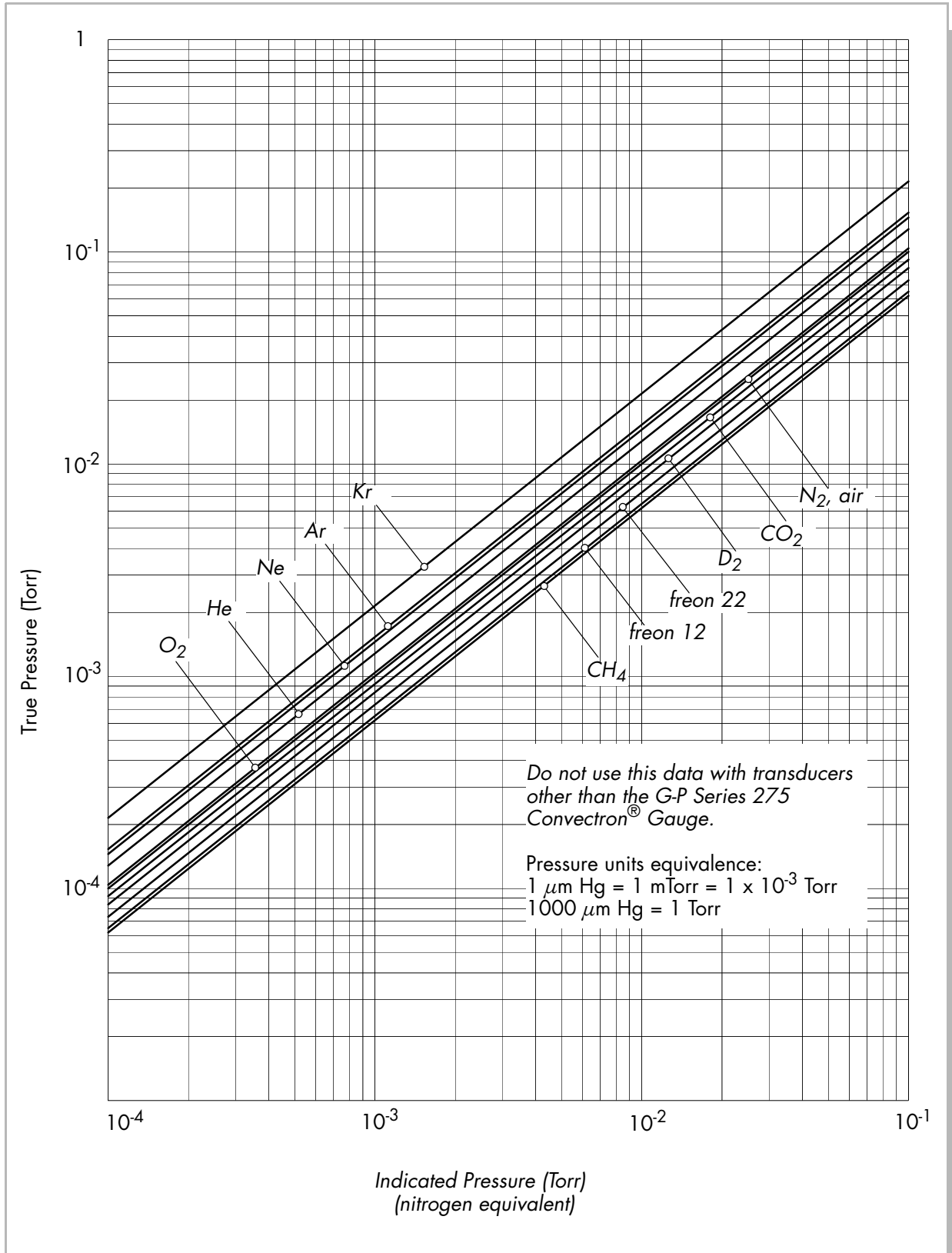

Figure 4-10 Convectron Gauge Indicated vs. True Pressure Curve; 10^{-4} to 10^{-1} Torr.

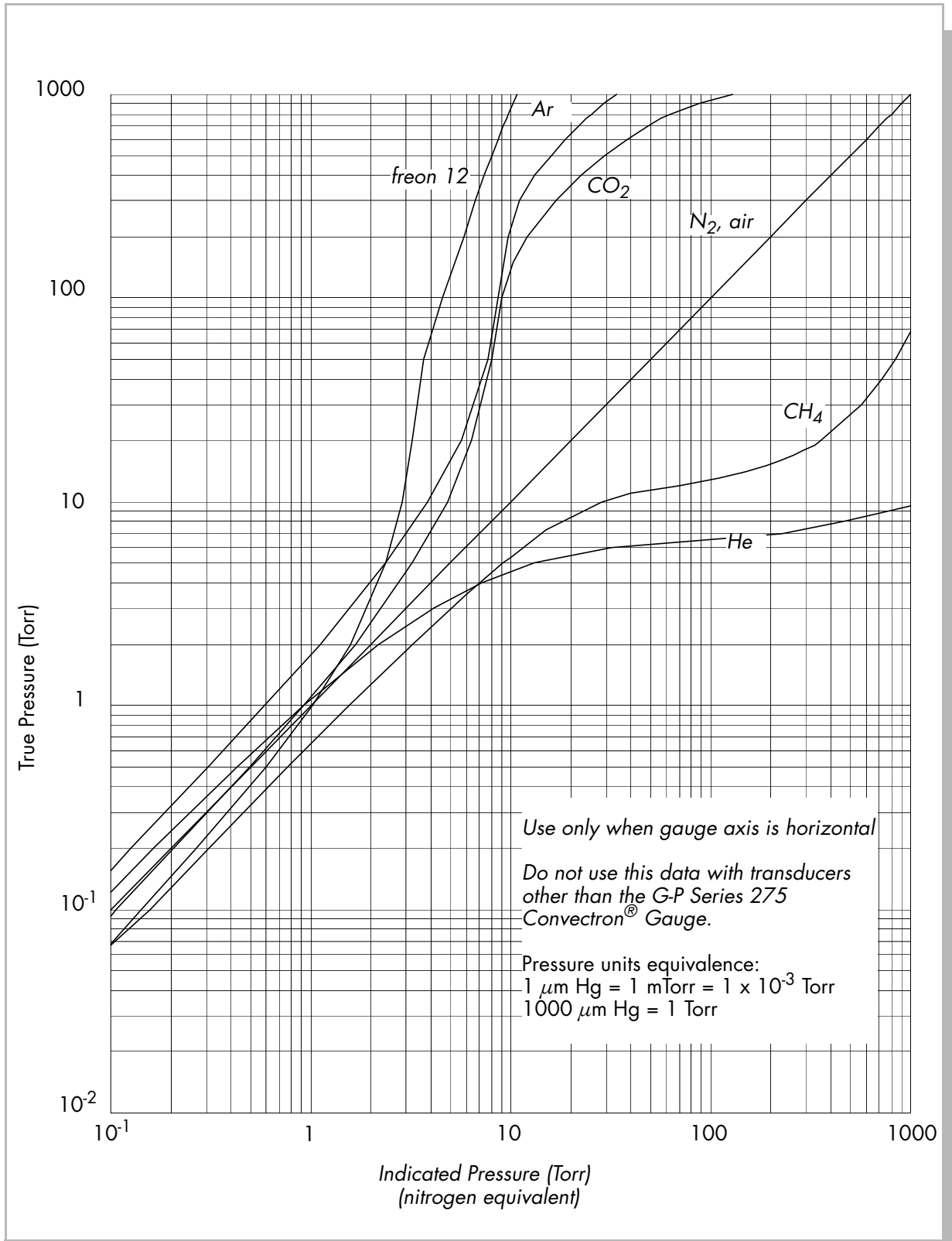

Figure 4-11 Convectron Gauge Indicated vs. True Pressure Curve; 10^{-1} to 1000 Torr.

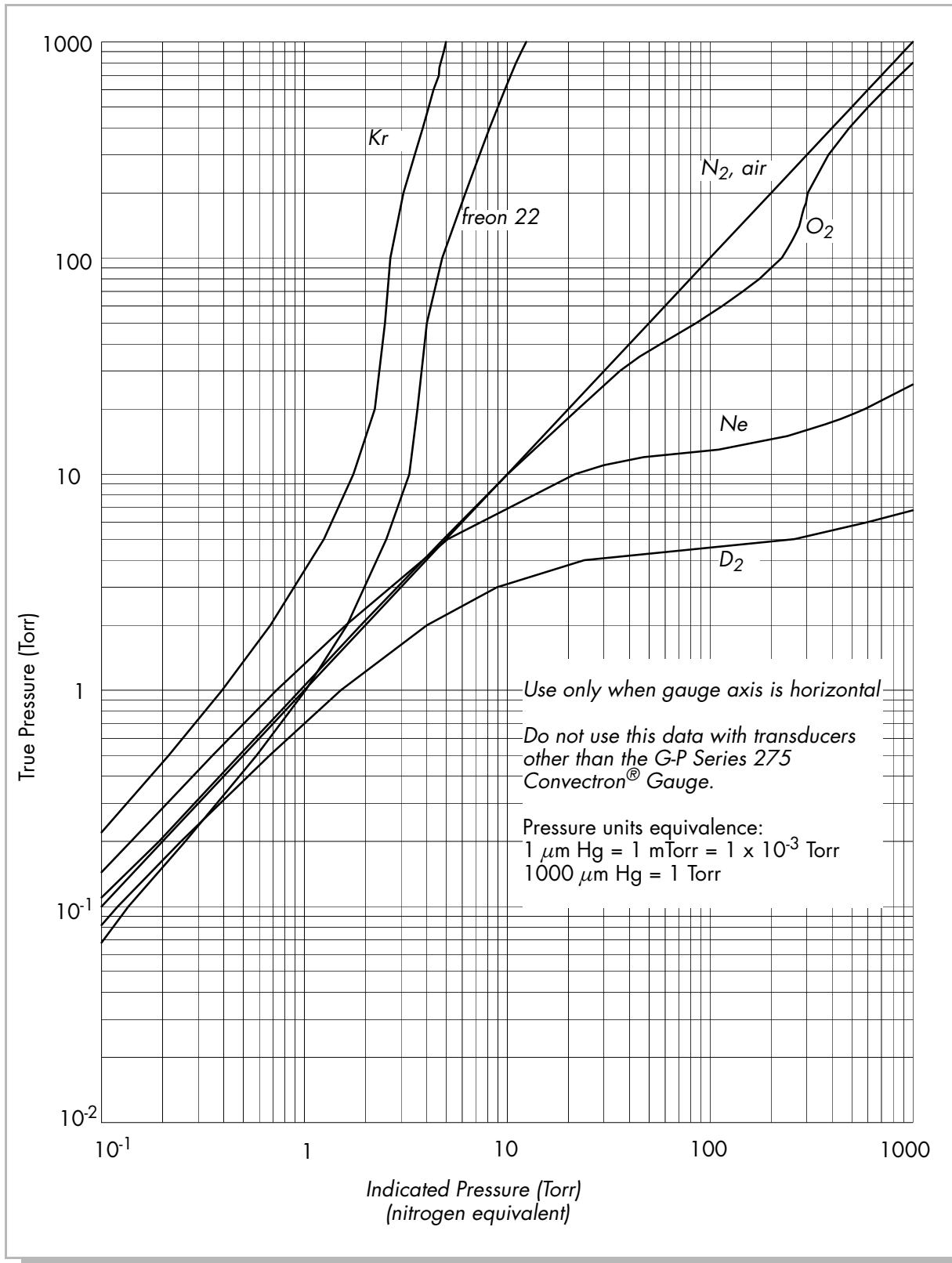

Figure 4-12 Convectron Gauge Indicated vs. True Pressure Curve; 10^{-1} to 1000 Torr.

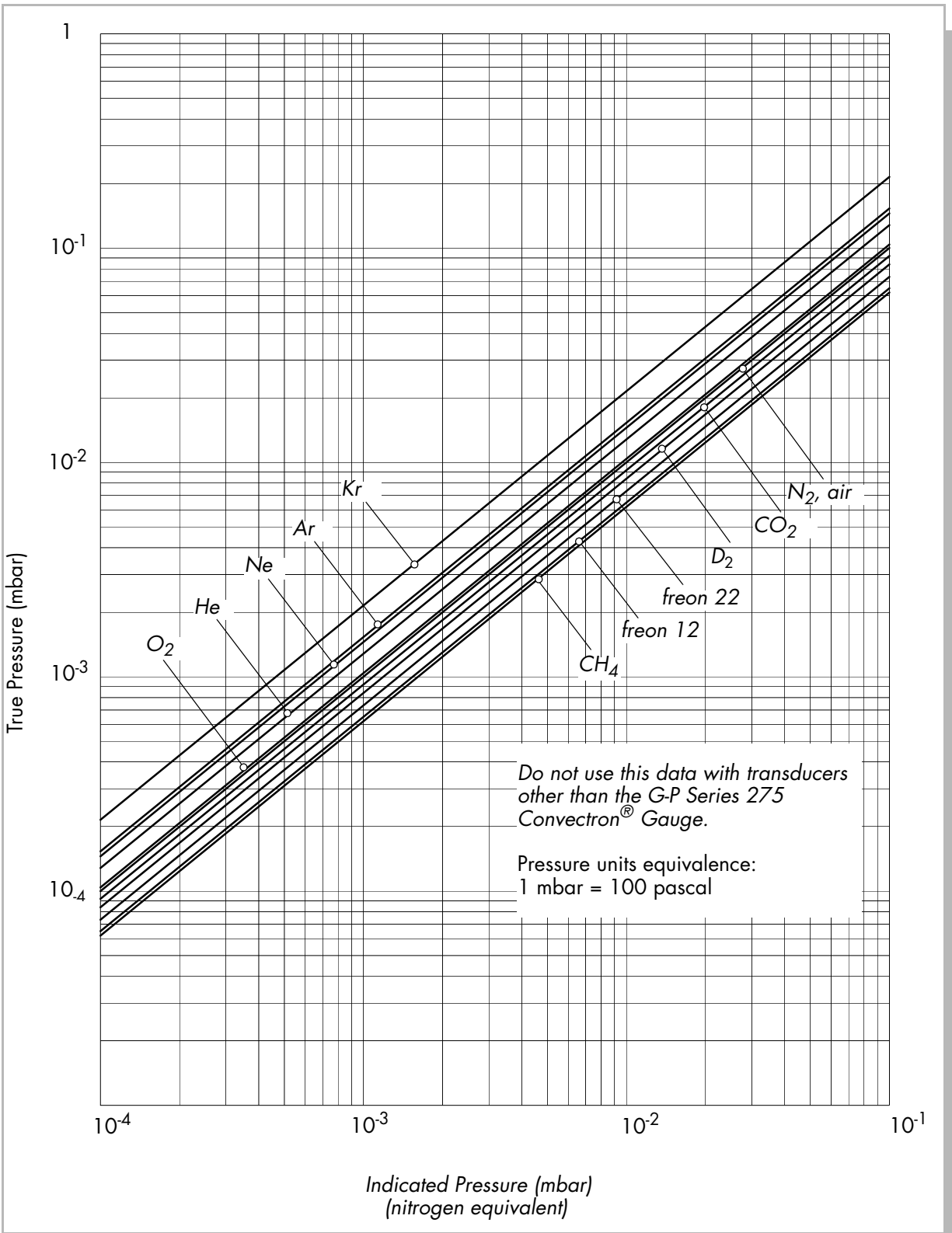

Figure 4-13 Convectron Gauge Indicated vs. True Pressure Curve; 10⁻⁴ to 10⁻¹ mbar.

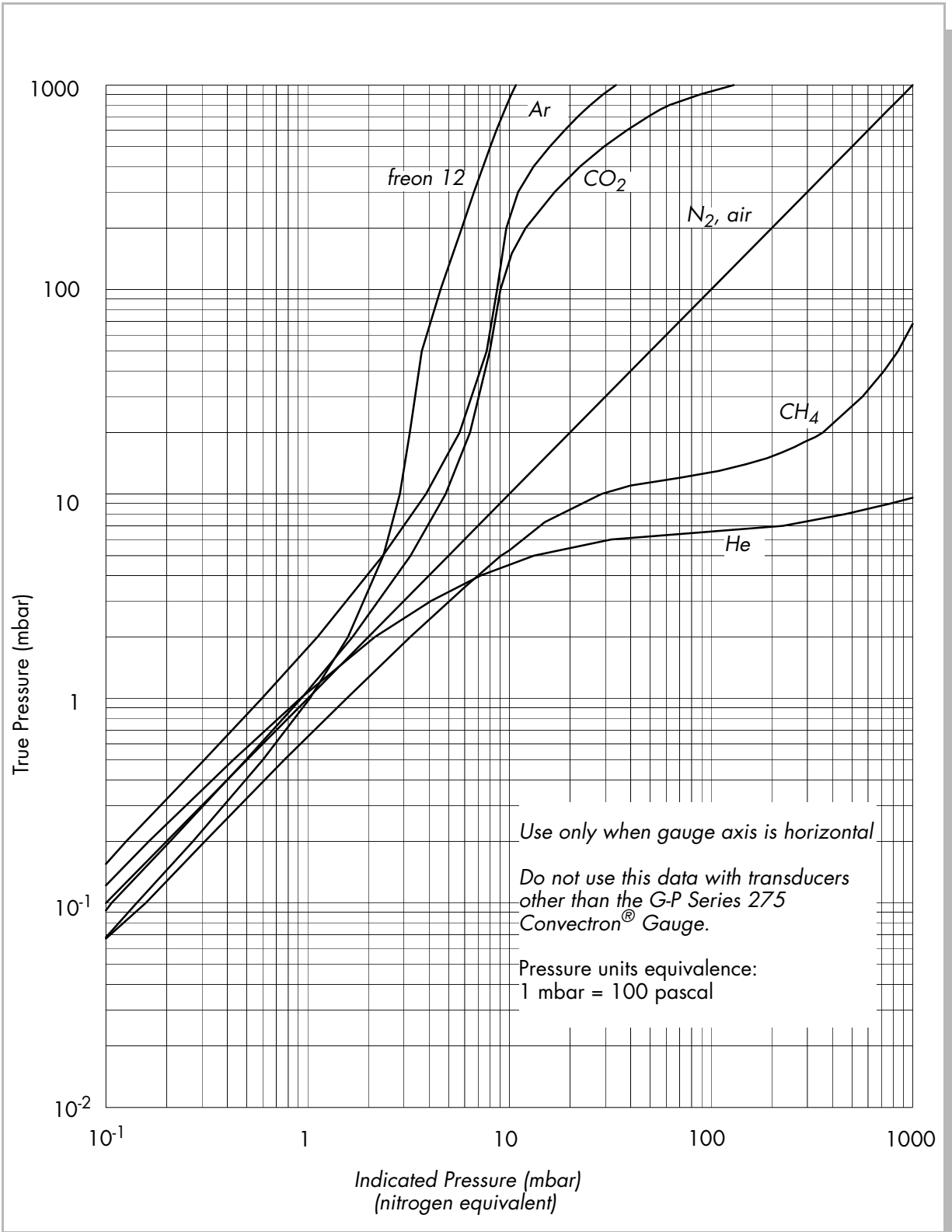

Figure 4-14 Convectron Gauge Indicated vs. True Pressure Curve; 10⁻¹ to 1000 mbar.

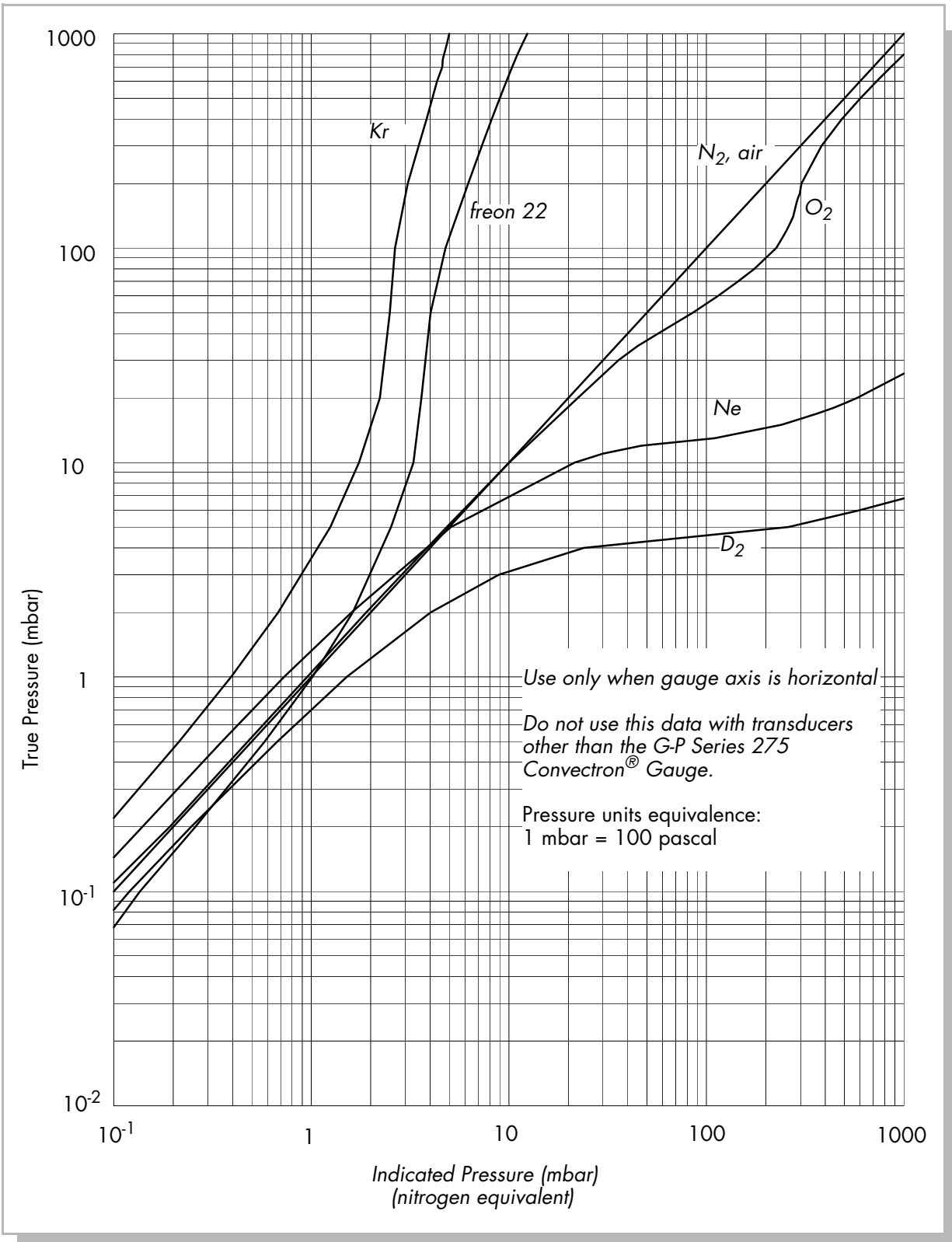

Figure 4-15 Convectron Gauge Indicated vs. True Pressure Curve; 10^{-1} to 1000 mbar.

4.7 Ionization Gauge Auto Turn On/Off



Warning – If used improperly, Convector Gauges can supply misleading pressure indications that can result in dangerous overpressure conditions within the system. For use with gases other than air or N₂, consult the gas type correction charts in Section 4.6.1 on page 4-12.

If a Convector Gauge is exposed to the same pressure environment as the Ion Gauge, then the Convector Gauge may be used to automatically turn on the IG. Convector Gauge A can turn on IG1 and Convector Gauge B can turn on IG2. Stabil-Ion Gauge automatic turn-on occurs when the Convector Gauge pressure drops below the auto turn-on setpoint defined by the auto turn-on setting. The Stabil-Ion Gauge will also be turned off automatically when the pressure rises slightly above the auto turn-on setpoint if the electrometer overpressure setpoint does not trip first.

The automatic on/off function will execute only once per setpoint crossing. For example, if the IG is turned off manually when below the setpoint, the auto-on function will not turn it back on until the Convector Gauge pressure has risen above the setpoint and then dropped below it again.

4.7.1 To Set the On/Off Pressure for IG1/IG2

1. Verify that the pressure indication for Convector Gauge A is reading above the desired setpoint. Alternatively, unplug Convector Gauge A. See note below.

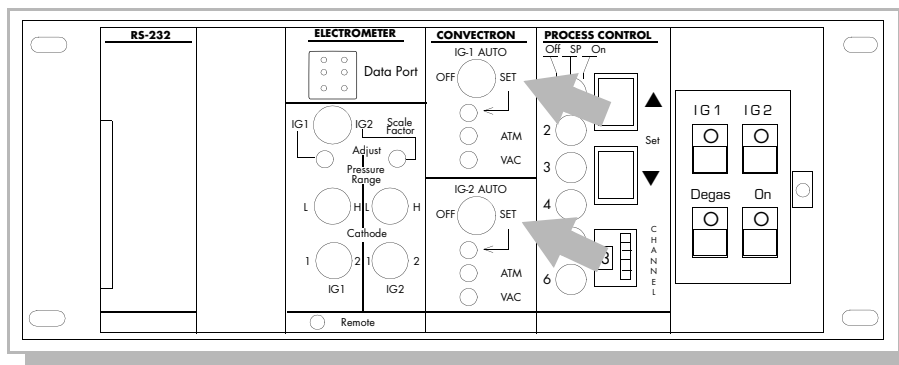

Figure 4-16 Control Unit Front Panel (with Door Open) Showing Ionization Gauge Auto Turn-On/Off Switches.

2. Place the AUTO switch for IG1 in the SET position. See Figure 4-16.
3. The existing turn on pressure is displayed on the A display.
4. Set the desired turn on pressure with the SET adjustment for IG1.
5. To deactivate this capability place the AUTO switch for IG1 in the OFF position.
6. Set the Convector Gauge B/IG2 function the same way.

Do not leave either switch in the SET position as this prevents pressure from being displayed.

4.8 Adjustment of Convector Gauge Zero and Atmospheric Pressure Indications



Using the N₂ calibration to pressurize a vacuum system above about 1 Torr with certain other gases can cause dangerously high pressures which may cause explosion of the system. See Section 4.6.1 on page 4-12 before using with other gases.

Each Convector Gauge is individually computer calibrated for N₂. Adjustment of the zero should not be necessary unless readout accuracy is required below 1×10^{-3} Torr. Adjustment of the atmospheric indication should not be necessary unless compensating for long cables or variations in mounting orientation. The Convector Gauge has a stable, temperature compensated design and each controller is also calibrated to provide accurate readout of N₂ pressure with any gauge when properly installed with the gauge axis horizontal.

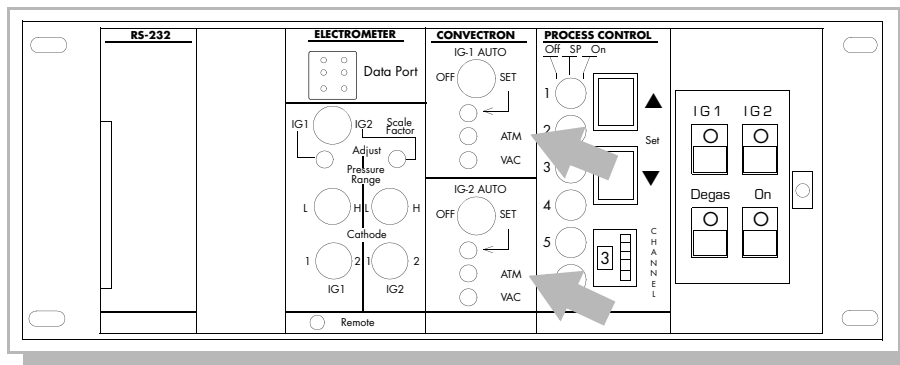

Figure 4-17 Control Unit Front Panel (with Door Open) Showing Convector Gauge Zero and Atmospheric Adjustments.

1. Evacuate Convector Gauge A to a pressure known to be less than 1×10^{-4} Torr.
2. With power on and at vacuum less than 1×10^{-4} Torr for at least 15 minutes, adjust VAC for gauge A (see Figure 4-17) until display A indicates 0.0 0 Torr/mbar or 0.0 0 Pa, not 1.0 -4, 1.0 -2, or 0.0 -0. A display of 0.0-0 indicates the gauge is set below 0.00.
3. Let the pressure in the gauge increase to the local atmospheric pressure.
4. Read the local atmospheric pressure on an accurate barometer nearby.
5. With the power on, adjust ATM adjustment for gauge A until display A indicates the local atmospheric pressure in the pressure units you have selected.
6. Repeat the above steps for Convector Gauge B.

4.9 Convectron Gauge Analog Output Signal

If the Convectron Gauge capability is installed, a voltage output signal proportional to the common logarithm of the pressure indication is provided on the rear panel of the Convectron Gauge module via a standard 1/8 in. miniature phone jack.

If graphed on log-linear axes, the output voltage is linear with respect to the log of pressure. The analog output is 1 volt per decade of pressure with a factory adjusted output of 0 volts at 1.0×10^{-4} Torr.

Offset adjustments are provided on the top edge of the Convectron Gauge module that allow shifting the voltage corresponding to 1×10^{-4} Torr between -7 volts and +1 volt.

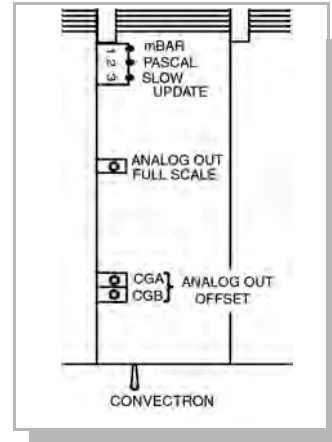

Figure 4-18 Top View of Convectron Gauge Module Showing Analog Output Offset Adjustment.

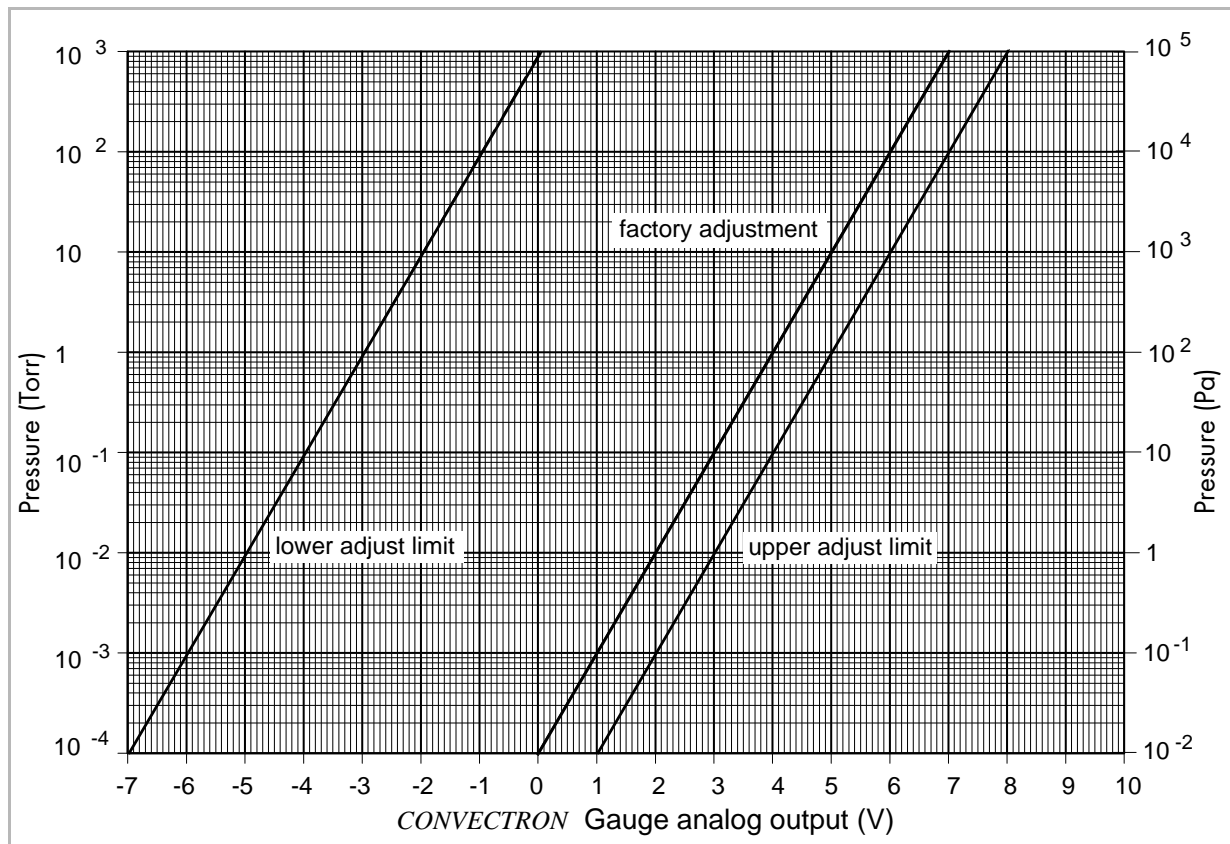

Figure 4-19 Convectron Gauge Analog Output vs. Pressure.

The voltage signal is smooth and continuous throughout all the decades of pressure measurement. This format is useful for computerized data acquisition because a simple equation (finding the common antilogarithm) may be programmed to calculate pressure from the voltage output.

The equation is: $P_i = 10^{V-4}$ Torr/mbar, or $P_i = 10^{V-2}$ Pascal

where P_i = pressure indication,

V = analog output voltage

and: the offset is at the factory adjusted 0V at 10^{-4} Torr (10^{-2} Pa).

If the offset has been adjusted to other than 0V at 10^{-4} Torr (10^{-2} Pa), then the exponent value must be forced to -4 (-2 for Pa) when the pressure is at 1.0×10^{-4} Torr (10^{-2} Pa) by adding or subtracting a number other than -4 from the value of V .

For example, if the offset has been adjusted so that the output voltage is -7 V at 10^{-4} Torr (10^{-2} Pa), then +3 (+5 for Pa) must be used in the equation instead of -4, i.e., $P = 10^{(-7+3)}$. Furthermore for the same offset, if the pressure were, say, 10^{-2} Torr, then the output voltage would be -5V. The pressure would be calculated as $P = 10^{(-5+3)}$.

4.10 Preparing for Process Control Operation

4.10.1 Setpoint Display and Adjustment

Setpoints are stored in non-volatile memory, and are specified by a 2-digit mantissa and 2-digit exponent. They may be set anywhere in the range 1.0×10^{-12} to $9.9 \times 10^{+5}$. This allows for the entire pressure range of the Stabil-Ion System and its units of measure to be covered.

The setpoint is compared directly to the display data, so units of measure are implicit. **Changing the units switch on the Controller will not change the stored setpoints.** They must be reprogrammed to the new units of measure.

If a setpoint is set to above atmosphere, then the relay will always be activated (unless its polarity is reversed, see Section 2.1.4 on page 2-5) except during transient conditions that occur, e.g. when the Stabil-Ion Gauge is first powered up, or a Convectron Gauge is disconnected. If it is desired that a process control relay be held in one state, the manual override switch should be used. If the setpoint is adjusted below 1.0×10^{-12} to 0.0, then it will always be deactivated (unless polarity is reversed).

4.10.2 To Display a Setpoint

1. Be sure the scale factor switch on the electrometer module is in its center position (Figure 4-20), or the calibration data in display line 1 will conflict with the display of setpoints 1 and 2.
2. Adjust the channel select thumbwheel to the number of the process control channel for which you wish to display the setpoint.
3. Press and release either SET button. The setpoint will appear for 2 seconds in the same display line as the associated gauge;
 - Setpoints 1 and 2 appear in the IG display line.
 - Setpoints 3 and 4 appear in display line A.
 - Setpoints 5 and 6 appear in display line B.

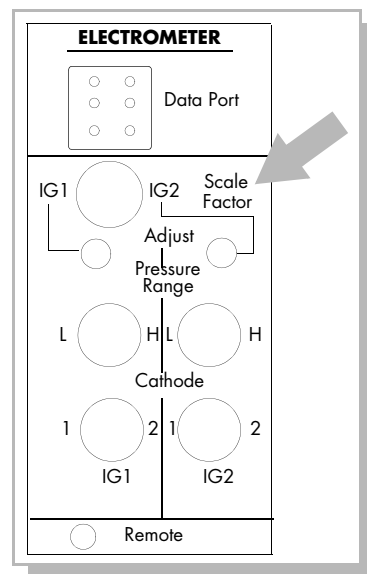

Figure 4-20 Electrometer Module Showing Scale Factor Switch.

4.10.3 To Modify a Setpoint

1. Adjust the channel thumbwheel to the number of the channel for which you wish to change a setpoint.
2. Press and hold the SET button for the direction you wish the setpoint to change; ▲ to raise the setpoint; ▼ to lower it. See Figure 4-21.
3. After holding the SET button in for about 5 seconds, the setpoint will scroll until the button is released. It will scroll slowly until a decade boundary is crossed and then will speed up to facilitate rapid changes across many decades. Release the button when you have entered the desired decade, and then depress it again to scroll slowly within the decade to reach the required setpoint.

After the setpoint button is released, the display will return to pressure data after 2 seconds. At this time the new setpoint will be deposited in non-volatile memory and will not change when the Controller is turned off.

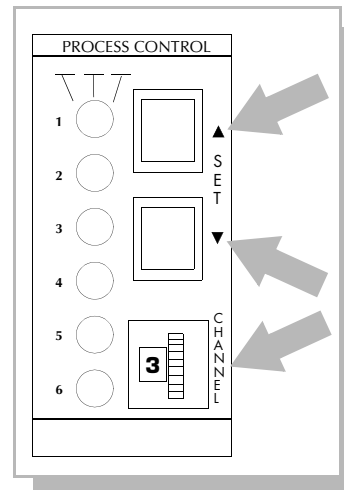

Figure 4-21 Process Control Module Showing Setpoint Set buttons and Channel Select Thumbwheel.

4.11 Preparing for Use of the RS-232 Computer Interface

For set up instructions see Section 2.1.5 on page 2-9.

For connection instructions see Section 3.8 on page 3-13.

Check the user's manual for the host computer to be sure the protocol used is compatible with that established via the switch configuration in the RS-232 module.

Communication with the Control Unit is via ASCII strings. A message consists of a command and a command modifier, followed by a terminator. The message may contain leading spaces, and the command and modifier may be optionally separated by spaces or commas. No spaces may appear within the command or the modifier, only between them.

The terminator expected by the Control Unit is an ASCII carriage-return line-feed, denoted here by CRLF. The carriage-return is optional, and messages terminated with only the line-feed will be accepted. Note that the CRLF terminator is appended automatically by the host computer's interface software to the message string supplied by the user.

If extra characters are found in the message after it has been successfully interpreted but before the terminator, they will be ignored. Characters can be upper- or lower-case. All messages to 360 will receive a reply, consisting of an ASCII string of upper-case letters terminated with CRLF. Pressures will be returned in the format X.XXE±XX.

4.11.1 RS-232 Command Syntax

DG

Definition: Turn degas on or off.

Modifiers: **ON** or **OFF**

Response: **OK** if command accepted, or **INVALID** if rejected.

Example: From computer: **DG ON CRLF**
From 360: **OKCRLF**

NOTES

1. Command is **INVALID** if neither IG is on.
2. A response to the **DG ON** command of **OK** indicates only that a signal requesting degas has been sent to the electrometer. Degas may fail to activate if the pressure is above 5×10^{-5} Torr. Use the **DGS** command (see below) to verify that degas has been successfully initiated.

DGS

Definition: Display degas status.

Modifiers: None

Response: ASCII **1** if degas is on, **0** if degas is off.

Example: From computer: **DGS CRLF**
From 360: **1CRLF**

DS

Definition: Display pressure reading.

Modifiers: **IG1** or **IG2** or **IG** or **CG1** or **CG2**.

Response: ASCII string representing the pressure for the selected gauge.

Example: From computer: **DS CG1 CRLF**
From 360: **1.25E-03CRLF**

NOTES

1. The **DS CG1** and **DS CG2** commands are used to display the pressures from the lower 2 display lines with the Convector Gauge Module installed.
2. If the requested ion gauge is turned off, or is in its first few seconds of operation, or data is requested from a Convector Gauge when none is installed, the Control Unit will return **9.90E+09**.

The **DS IG** command will return pressure from the gauge which is on, and **9.99E+09** if neither is on

IG1

Definition: Turn IG1 on or off.

Modifiers: **ON** or **OFF**

Response: **OK** if command accepted, **INVALID** if rejected.

Example: From computer: **IG1 ONCRLF**
From 360: **OKCRLF**

NOTES

1. The **IG1 ON** command will be rejected as **INVALID** if IG1 is already on, and **IG1 OFF** will be rejected if IG1 is already off.
2. A response to the **IG1 ON** command of **OK** indicates only that a signal requesting that IG1 be turned on has been sent to the electrometer. IG1 may fail to come on, e.g., if the system pressure is too high or if the gauge is disconnected. To verify that IG1 is on, use the **DS IG1** command. If the gauge is off, or in its first few seconds of operation after being turned on, a pressure of **9.99E+9** will be returned.

IG2

Identical to **IG1**, but applies to IG2.

PCS

Definition: Display process control channel status.

Modifiers: **1** or **2** or **3** or **4** or **5** or **6** or **B** or none.

Response: Depends on modifier:

Modifier = single digit (1 through 6); response = single ASCII digit, **0** if the corresponding relay is inactive, **1** if active. See Example 1.

Modifier = **B**; response = a byte of data with bits 0 through 5 set/clear according to whether the corresponding relay is active/inactive. Bit 6 will always be set to guarantee that the returned byte will not appear as a terminator byte. See Example 2.

Modifier absent; response will be a string of 6 ASCII 0's and 1's separated by commas giving the status of all six channels. See Example 3.

Examples: Assume that channels 1 - 3 are active, and 4 - 6 are inactive:

1. From computer: **PCS 1 CRLF**

From 360: **1CRLF**

2. From computer: **PCS B CRLF**

From 360: **GCRLF**

(Note that ASCII "G" corresponds to the bit pattern 01000111 and represents the status of the PC channels in bits 0 through 5).

3. From computer: **PCS CRLF**

From 360: **1,1,1,0,0,0 CRLF**

CATH1

Definition: Select Cathode 1 or Cathode 2 for IG1 operation.

Modifiers: **1** or **2**

Response: **OKCRLF**

Example: From computer: **CATH1 2 CRLF**

From 360: **OKCRLF**

NOTES

This function can be implemented from the electrometer front panel or from the remote setup connector as well as from the computer interface.

CATH2

Identical to **CATH1** except applies to IG2.

PR1

Definition: Select pressure range for IG1 operation.

Modifiers: **L** or **H**

Response: **OKCRLF**

Example: From computer: **PR1 L**

From 360: **OKCRLF**

NOTES

This function can be implemented from the electrometer front panel or from the remote setup connector as well as from the computer interface.

PR2

Identical to PR1 except applies to IG2.

SWS

Definition: Display status of gauge control switches/remotes.

Modifiers: none

Response: **0** (cath1 #1), **0** (cath2 #1), **0** (pr1 low), **0** (pr2 low)
1 (cath1 #2), **1** (cath2 #2), **1** (pr1 high), **1** (pr2 high)

Example: If the Controller is set for pressure range 1 low, pressure range 2 high, cathode 1 #1, and cathode 2 #2, then the response would be: **0, 1, 0, 1 CRLF**

GTL

Definition: Send control back to the electrometer front panel switches.

Modifiers: none

Response: **OK** if command accepted, or **INVALID** if rejected.

LLO

Definition: Local lockout of the electrometer front panel gauge control switches.

Modifiers: none

Response: **OK** if command accepted, or **INVALID** if rejected.

Error Messages

If an error is found in the incoming message, the following messages will be returned in place of the normal response.

OVERRUN ERROR – Returned if the incoming message overflows 360's buffer.

SYNTAX ERROR – Returned if the message fails to parse as a valid 360 command.

4.12 Preparing for use of the RS-485 Computer Interface

Setup Instructions for the RS-485 computer interface are in Section 2.1.6 on page 2-12

The Series 360 Controller uses a command-response half-duplex protocol. If the controller recognizes received data as a valid command, it will check the command string address and compare with its own. If the addresses match, the controller will process the command and then respond. In all configurations, only one twisted pair will have data transmissions in one direction at any time. The timing of the data transfer is shown in Figure 4-22. T0 is 10-13 mS + 10 bit times with S2.1 in the OFF position, T0 is greater than 700 microseconds with S2.1 in the ON position, and T1 is greater than 300 microseconds. Adhering to these timing constraints will ensure data is not overwritten.

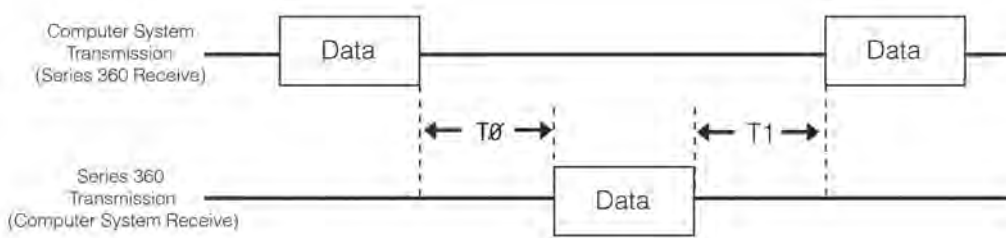

Figure 4-22 RS-485 Data Timing

Consult the user's manual for the host computer to be sure the character framing settings used are in accord with that established via the switch configuration you have chosen for the RS-485 module.

Communication is via ASCII strings. A message to consists of a start character "#", an address "AA", command, and a command modifier, followed by a terminator. The message may contain leading spaces, and the command and modifier may optionally be separated by spaces. No spaces may appear within the command or the modifier, only between them.

The address expected is programmed via the switch settings on the rear of the module. The syntax is "#AA" where AA is an ASCII representation of the hex address of the controller. The terminator expected is an ASCII carriage-return denoted here by CR. Note that the terminator is sometimes appended automatically, by the host computer's interface software, to the message string supplied by the user. If extra characters are found in the message after it has been successfully interpreted but before the terminator, they will be ignored.

All messages will receive a reply, consisting of an ASCII string terminated with CR. Pressure numbers will be returned in the format X.XXE±XX.

Messages may use upper or lower case alpha characters. The controller will always respond with upper case characters.

4.12.1 RS-485 Command Syntax

IG1

Definition: Turn IG1 on or off.

Modifiers: **ON** or **OFF**

Response: **OK** if command accepted, **INVALID** if rejected.

Example: From computer: **IG1 ONCRLF**

From 370: **OKCRLF**

NOTES

1. The **IG1 ON** command will be rejected as **INVALID** if IG1 is already on, and **IG1 OFF** will be rejected if IG1 is already off.
2. A response to the **IG1 ON** command of **OK** indicates only that a signal requesting that IG1 be turned on has been sent to the electrometer. IG1 may fail to come on, e.g., if the system pressure is too high or if the gauge is disconnected. To verify that IG1 is on, use the **DS IG1** command. If the gauge is off, or in its first few seconds of operation after being turned on, a pressure of **9.99E+9** will be returned.

IG2

Identical to **IG1**, but applies to IG2.

DG

Definition: Turn degas on or off

Modifiers: **ON** or **OFF**

Response: **OK** if command accepted, or **INVALID** if rejected.

Example: From computer: **DG ON CRLF**

From 370 **OKCRLF**

NOTES

1. Command is **INVALID** if neither IG is on.
2. A response to the **DG ON** command of **OK** indicates only that a signal requesting degas has been sent to the electrometer. Degas will not activate if the pressure is above 5×10^{-5} Torr. Use the **DGS** command (see below) to verify that degas has been successfully initiated.

DS

Definition: Display pressure reading.

Modifiers: **IG1** or **IG2** or **IG** or **CG1** or **CG2**.

Response: ASCII string representing the pressure for the selected gauge.

Example: From computer: **DS CG1 CRLF**

From 370: **1.25E-03CRLF**

NOTES

1. The **DS CG1** and **DS CG2** commands are used to display the pressures from the lower 2 display lines with the Convector Gauge Module installed.
2. If the requested ion gauge is turned off, or is in its first few seconds of operation, or data is requested from a Convector Gauge when none is installed, the Control Unit will return **9.90E+09**.

The **DS IG** command will return pressure from the gauge which is on, and **9.99E+09** if neither is on.

DGS

Definition: Display degas status.
 Modifiers: None
 Response: ASCII **1** if degas is on, **0** if degas is off.
 Example: From computer: **DGS CRLF**
 From 370: **1CRLF**

PCS

Definition: Display process control channel status.
 Modifiers: **1** or **2** or **3** or **4** or **5** or **6** or **B** or none.
 Response: Depends on modifier:
 Modifier = single digit (1 through 6); response = single ASCII digit, **0** if the corresponding relay is inactive, **1** if active. See Example 1.
 Modifier = **B**; response = a byte of data with bits 0 through 5 set/clear according to whether the corresponding relay is active/inactive. Bit 6 will always be set to guarantee that the returned byte will not appear as a terminator byte. See Example 2.
 Modifier absent; response will be a string of 6 ASCII 0's and 1's separated by commas giving the status of all six channels. See Example 3.

Examples: Assume that channels 1 - 3 are active, and 4 - 6 are inactive:

1. From computer: **PCS 1 CRLF**

From 360 Controller: **1CRLF**

2. From computer: **PCS B CRLF**

From 360 Controller: **G CRLF**

(Note that ASCII "G" corresponds to the bit pattern 01000111 and represents the status of the PC channels in bits 0 through 5).

3. From computer: **PCS CRLF**

From 360 Controller: **1,1,1,0,0,0 CRLF**

4.13 Preparing for Use of the IEEE 488 Computer Interface

For setup instructions see Section 2.1.7 on page 2-15.

For connecting instructions see Section 3.10 on page 3-18.

Communication with the 360 Controller is via ASCII strings. A message to the 360 consists of a command and a command modifier, followed by a terminator. The message may contain leading spaces, and the command and modifier may optionally be separated by spaces or commas. No spaces may appear within the command or the modifier, only between them.

The terminator accepted by the 360 is an ASCII carriage-return line-feed, or New Line denoted here by CRLF. The carriage-return is optional, and messages terminated with only the line-feed will be accepted. Note that the CRLF terminator is, in general, appended automatically by the host computer's interface software to the message string supplied by the user.

A terminator is not required if the last character of the message to the 360 VGC is accompanied by the EOI bus signal. If extra characters are found in the message after it has been successfully interpreted but before the terminator, they will be ignored. Characters can be upper or lower case. Response characters will be upper case.

All messages to the 360 will receive a reply consisting of an ASCII string terminated with CRLF; the LF being accompanied by an EOI. Pressures will be returned in the format X.XXE±XX.

4.13.1 IEEE 488 Command Syntax

DG

Definition: Turn degas on or off.

Modifiers: **ON** or **OFF**

Response: **OK** if command accepted, or **INVALID** if rejected.

Example: From computer: **DG ON CRLF**
From 360 **OKCRLF**

NOTES

1. Command is **INVALID** if neither IG is on.
2. A response to the **DG ON** command of **OK** indicates only that a signal requesting degas has been sent to the electrometer. Degas may fail to activate if the pressure is above 5×10^{-5} Torr. Use the DGS command (see below) to verify that degas has been successfully initiated.

DGS

Definition: Display degas status.

Modifiers: None

Response: ASCII **1** if degas is on, **0** if degas is off.

Example: From computer: **DGSCRLF**
From 360: **1CRLF**

DS

Definition: Display pressure reading.

Modifiers: **IG1** or **IG2** or **IG** or **CG1** or **CG2**.

Response: ASCII string representing the pressure for the selected gauge.

Example: From computer: **DS CG1 CRLF**
 From 360: **1.20E-03CRLF**

NOTES

1. The **DS CG1** and **DS CG2** commands are used to display the pressures from the lower 2 display lines with the Convector Gauge Module installed.
2. If the requested ion gauge is turned off, or is in its first few seconds of operation, or data is requested from a Convector Gauge when none is installed, the 360 will return **9.99E+09**.
 The **DS IG** command will return pressure from the gauge which is on, and **9.99E+09** if neither is on.

IG1

Definition: Turn IG1 on or off.
 Modifiers: **ON** or **OFF**
 Response: **OK** if command accepted, **INVALID** if rejected.
 Example: From computer: **IG1 ONCRLF**
 From 360: **OKCRLF**

NOTES

1. The **IG1 ON** command will be rejected as **INVALID** if IG1 is already on, and **IG1 OFF** will be rejected if IG1 is already off.
2. A response to the **IG1 ON** command of **OK** indicates only that a signal requesting that IG1 be turned on has been sent to the electrometer. IG1 may fail to come on, e.g., if the system pressure is too high or if the gauge is disconnected. To verify that IG1 is on, use the **DS IG1** command. If the gauge is off, or in its first few seconds of operation after being turned on, a pressure of **9.99E+9** will be returned.

IG2

Identical to **IG1**, but applies to IG2.

PCS

Definition: Display process control channel status.
 Modifiers: **1** or **2** or **3** or **4** or **5** or **6** or **B** or none.
 Response: Depends on modifier:
 Modifier = single digit (1 through 6); response = single ASCII digit, **0** if the corresponding relay is inactive, **1** if active. See Example 1.
 Modifier = **B**; response = a byte of data with bits 0 through 5 set/clear according to whether the corresponding relay is active/inactive. Bit 6 will always be set to guarantee that the returned byte will not appear as a terminator byte. See Example 2.
 Modifier absent; response will be a string of 6 ASCII 0's and 1's separated by commas giving the status of all six channels. See Example 3.

Examples: Assume that channels 1 - 3 are active, and 4 - 6 are inactive:
 1. From computer: **PCS 1 CRLF**
 From 360: **1CRLF**

2. From computer: **PCS B CRLF**

From 360: **GCRLF**

(Note that ASCII "G" corresponds to the bit pattern 01000111 and represents the status of the PC channels in bits 0 through 5).

3. From computer: **PCS CRLF**

From 360: **1,1,1,0,0,0 CRLF**

CATH1

Definition: Select Cathode 1 or Cathode 2 for IG1 operation.

Modifiers: **1** or **2**

Response: **OK CRLF**

Example: From computer: **CATH1 2 CRLF**

From 360: **OK CRLF**

NOTES

This function can be implemented from the electrometer front panel or from the remote setup connector as well as from the computer interface.

CATH2

Identical to **CATH1** except applies to IG2.

PR1

Definition: Select pressure range for IG1 operation.

Modifiers: **L** or **H**

Response: **OK CRLF**

Example: From computer: **PR1 L**

From 360: **OK CRLF**

NOTES

This function can be implemented from the electrometer front panel or from the remote setup connector as well as from the computer interface.

PR2

Identical to **PR1** except applies to IG2.

SWS

Definition: Display status of gauge control switches/remotes.

Modifiers: none

Response: **0** (cath1 #1), **0** (cath2 #1), **0** (pr1 low), **0** (pr2 low)

1 (cath1 #2), **1** (cath2 #2), **1** (pr1 high), **1** (pr2 high)

Example: If the Controller is set for pressure range 1 low, pressure range 2 high, cathode 1 #1, and cathode 2 #2, then the response would be: **0, 1, 0, 1 CRLF**

GTL

Definition: Send control back to the electrometer front panel switches.

Modifiers: none

Response: **OK** if command accepted, or **INVALID** if rejected.

LLO

Definition: Local lockout of the electrometer front panel gauge control switches.

Modifiers: none

Response: **OK** if command accepted, or **INVALID** if rejected.

Error Messages

If an error is found in the incoming message, the following messages will be returned in place of the normal response, and if the SRQ mode is used, bit 5 in the serial poll response byte will be set.

OVERRUN ERROR – Returned if the incoming message overflows 360's buffer.

SYNTAX ERROR – Returned if the message fails to parse as a valid 360 command.

Operation of a Stabil-Ion System

The instructions in this chapter assume the instructions for Setup, Installation, and Preparing For Operation have been completed. See Chapters 2, 3, and 4.

1. Press the power ON switch on the Control Unit (see Figure 5-1).
2. If Convectron Gauge capability is installed, Convectron Gauge pressures will be displayed on lines A and B of the display whenever the power switch is on.

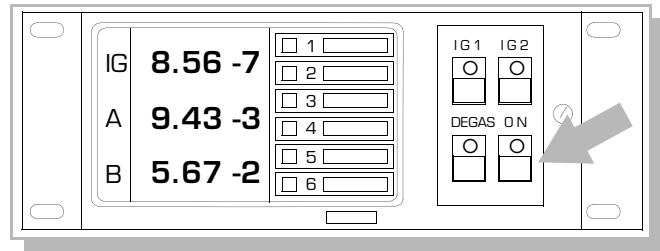

Figure 5-1 Control Unit Front Panel Showing Power ON Button.

Table 5-1 Convectron Gauge Display Formats.

Units	Display Format	Pressure	Example
torr	scientific	< 1 Torr	3.23-3 Torr
	floating point	> 1 Torr	7.15 Torr
mbar	scientific	< 1 mbar	5.18-2 mbar
	floating point	> 1 mbar	88.6 mbar
	scientific	> 999 mbar	1.23+3 mbar
pascal	scientific	< 1 Pa	7.23-1 Pa
	floating point	> 1 Pa	78.3 Pa
	scientific	> 999 Pa	1.25+4 Pa

During a fast pumpdown from atmosphere, thermal effects will prevent the Convectron Gauge from tracking pressure accurately below 10^{-3} Torr. After about 15 minutes, indications in the 10^{-4} range will be valid and response will be rapid. Zero adjustment at vacuum may be performed at this time (or sooner if readings in the 10^{-4} range are not needed).

In the 10^{-4} Torr range, the indication is accurate to about ± 0.1 millitorr provided the instrument has been carefully zeroed at vacuum. See Section 4.8 on page 4-22 for vacuum and atmosphere calibration procedures. For accurate use in the 10^{-4} range, zeroing should be repeated frequently.

3. If you have Convector Gauge capability installed and have prepared your system for automatic operation of the Stabil-Ion Gauge(s) per Section 4.7 on page 4-21, the ionization gauge(s) will turn on and off automatically.
4. For manual operation, press the Stabil-Ion Gauge 1 (or 2) power switch, IG1 (or IG2), on the Control Unit. The pressure in Stabil-Ion Gauge 1 (or 2) will be displayed on the IG line of the display in the chosen pressure units.
5. To degas IG1 (IG1 must be on and the pressure within IG1 must be below 5×10^{-5} Torr), depress the DEGAS switch on the Control Unit (see Figure 5-2). When degassing with cathode 1 selected, both cathodes will operate in order to achieve full degas power and thorough cleaning of both cathodes.

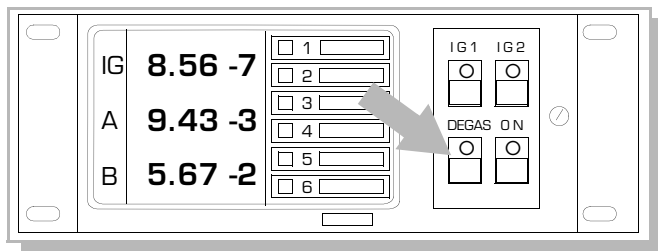

Figure 5-2 Control Unit Front Panel Showing DEGAS Button and LED Indicator.

When cathode 2 is selected, only cathode 2 will be powered during degas, and the power will be reduced to half in order to prevent the second cathode from exceeding its emission rating.

6. When either cathode is nearing the end of its useful lifetime or is badly contaminated, the DEGAS switch LED indicator on the front panel will blink during degassing (see Figure 5-2). This is an indication that the cathode emission properties have deteriorated. This may be due to contamination which has temporarily “poisoned” the cathode coating, or to long term permanent erosion of the coating. If this condition does not disappear after a few days of operation at clean high vacuum or UHV, it is an indication that one or both cathodes are approaching their end of life. See Section 6.6 on page 6-7 for more discussion.
7. Stable pressure measurement requires that all the environmental parameters in, on, and around the vacuum gauge and vacuum system remain unchanged during measurement. Therefore, never attempt meaningful measurements immediately after turning on the Stabil-Ion Gauge or immediately after degassing the gauge. Permit sufficient time for the environmental parameters to stabilize.

Service and Maintenance

6.1 Service Guidelines

Some minor difficulties are readily corrected in the field. Each module has fault indicator LEDs which help localize failures.

If a qualified service person makes repairs at the component level, repairs properly made with equivalent electronic parts and rosin core solder do not void the warranty.

If the product requires service, contact the MKS, Granville-Phillips Division Customer Service Department at +1-800-227-8766 or +1-303-652-4691 for troubleshooting help over the phone.

If the product must be returned to the factory for service, request a Return Material Authorization (RMA) from Granville-Phillips. Do not return products without first obtaining an RMA. In some cases a hazardous materials document may be required. The MKS/Granville-Phillips Customer Service Representative will advise you if the hazardous materials document is required.

When returning a products to Granville-Phillips, be sure to package the products to prevent shipping damage. Circuit boards and modules separated from the gauge assembly must be handled using proper anti-static protection methods and must be packaged in anti-static packaging. Granville-Phillips will supply return packaging materials at no charge upon request. Shipping damage on returned products as a result of inadequate packaging is the Buyer's responsibility.

For Customer Service or Technical Support 24 hours per day, 7 days per week, every day of the year including holidays:

Phone: +1-800-227-8766 or +1-303-652-4691

Email: gp-csr@mksinst.com

MKS, Granville-Phillips Division

6450 Dry Creek Parkway

Longmont, CO 80503 USA

Phone: 1-303-652-4691 or 1-800-776-6543

FAX: 1-303-652-2844

Because the 370 Controller contains static-sensitive electronic parts, the following precautions must be followed when troubleshooting:

- Use a grounded, conductive work surface. Wear a high impedance ground strap for personnel protection.
- Use conductive or static dissipative envelopes to store or ship static sensitive devices or printed circuit boards.
- Do not operate the product with static sensitive devices or other components removed from the product.
- Do not handle static sensitive devices more than absolutely necessary, and only when wearing a ground strap.
- Do not use an ohmmeter for troubleshooting MOS circuits. Rely on voltage measurements.
- Use a grounded, electrostatic discharge safe soldering iron.

NOTE: This product was designed and tested to offer reasonably safe service provided it is installed, operated, and serviced in strict accordance with these safety instructions.



Danger, High Voltage – The high voltages present within the Power Supply are capable of causing injury or death. To avoid electric shock, wait 3 minutes after power is removed before touching any component within the Power Supply. This will permit charged capacitors to discharge.



The service and repair information in this manual is for the use of Qualified Service Personnel. To avoid shock, do not perform any procedures in this manual or perform any servicing on this product unless you are qualified to do so.



Do not substitute parts or modify instrument.

Because of the danger of introducing additional hazards, do not install substitute parts or perform any unauthorized modification to the product. Return the product to a service facility designated by Granville-Phillips for service and repair to ensure that safety features are maintained. Do not use this product if it has unauthorized modifications.

6.2 Damage Requiring Service

Disconnect this product from the wall outlet and any other power sources, and refer servicing to Qualified Service Personnel if any the following conditions exist:

- The gauge cable, power-supply cord, or plug is damaged.
- Liquid has been spilled onto, or objects have fallen into, the product.
- The product has been exposed to rain or water.
- The product does not operate normally even if you have followed the Operation Instructions. Adjust only those controls that are covered in the instruction manual. Improper adjustment of other controls may result in damage and require extensive work by a qualified technician to restore the product to its normal operation.
- The product has been dropped or the enclosure has been damaged.
- The product exhibits a distinct change in performance. This may indicate a need for service.



Replacement Parts - When replacement parts are required, be certain to use the replacement parts that are specified by Granville-Phillips, or that have the same characteristics as the original parts. Unauthorized substitutions may result in fire, electric shock or other hazards.



Safety Check - Upon completion of any service or repairs to this product, ask the Qualified Service Person to perform safety checks to determine that the product is in safe operating order.



Finite Lifetime - After ten years of normal use or even non-use, the electrical insulation in this product may become less effective at preventing electrical shock. Under certain environmental conditions which are beyond the manufacturer's control, some insulation material may deteriorate sooner. Therefore, periodically inspect all electrical insulation for cracks, crazing, or other signs of deterioration. Do not use if the electrical insulation has become unsafe.

Table 6-1 General Symptoms/Possible Causes.

Symptom	Possible Cause
Unit will not power-up, no response to power switch.	Power fuse blown. Incorrect line voltage selection, see Section 2.2 on page 2-17. Power interconnect cable improperly connected. See Figure 3-21 on page 3-21.
Power fuse blows repeatedly.	Incorrect fuse rating. Incorrect line voltage selection, see Section 2.2 on page 2-17.
Fault relay tripped.	Unplugged Convectron Gauge or sensor broken in Convectron Gauge. Convectron Gauge zero badly out of calibration. Microprocessor reset occurring on a module (probable circuit failure). Checksum failure on process control board. (See Section 6.10 on page 6-10.) Cycle power and check all setpoints.
IG will not turn on, or turns on briefly then shuts off.	IG at too high pressure. Auto turn off circuit in Convectron Gauge module is shutting off IG. Emission current setting wrong for pressure in gauge. Improper IG connector hookup. Badly contaminated IG. Damaged or contaminated cathode coating, will not sustain emission. Try alternate cathode. Short in IG cable. Short between IG electrodes. Open cathode in IG. Try alternate cathode.
IG display shows a steady number when IG is off.	Scale factor switch is not in its center position.
Convectron Gauge display reads a fixed (non changing) pressure.	IG AUTO switch is left in the SET position.
Pressure reading is higher than expected.	IG contaminated. Low (L) pressure range is not selected appropriately (pressure is below 10^{-7} Torr). Interference from other ion source. Poor conductance in gauge's vacuum connection to chamber. Gas source in plumbing to gauge, such as leak or contamination. Chamber pressure high because of leak, contamination, or pump failure. Poor location selected for gauge. Faulty gauge or power cable. Faulty electrometer.

Symptom	Possible Cause
Degas will not turn on.	System pressure above 5×10^{-5} Torr. IG not turned on.
IG shuts off when degas is initiated.	Degas fuse blown. Badly contaminated IG.
IG pressure reads extremely low.	Collector unplugged. Bad collector cable. Faulty electrometer.
IG pressure readout very erratic.	IG badly contaminated. Improper IG or Controller grounding. Bad collector cable. Excessive noise source. Interference from other charged particle source in chamber. Faulty electrometer.
Green +18 LED out on control board.	Improper connection of Power Supply cable. +18 volt supply to relays faulty.
Green +15 LED out.	+15 volt supply faulty (power to analog circuitry and RS-232).
Green -15 LED out.	-15 volt supply faulty (power to analog circuitry and RS-232).
Green +5 display LED out.	+5 volt supply to display LED's faulty.
Green +5 logic LED out.	+5 volt logic supply faulty.

6.3 Fault Relay

When supplied with the available factory installed Stabil-Ion Remote Control (Cat. No. 360104), the 360 Control Unit is equipped with a "Fault" relay. The SPDT relay contacts are located on the remote output connector (See Figure 6-1). The relay is energized when no fault condition is detected. The relay is de-energized when:

- There is a fault condition detected by one of the microprocessors.
- There is a microprocessor failure causing the watchdog timer to reset.
- Power is lost due to Power Supply failure.
- Power is removed from the instrument.
- The power switch is turned off.

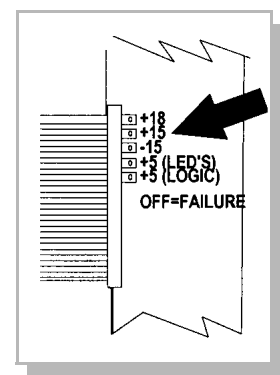

Figure 6-1

Control Board Top View Showing Green Power Indicator LED's.

The source of the fault signal can be determined by observing the fault indicating red LED's and the Power Supply monitor's green LED's located beneath the Control Unit's cover (see Figure 1-8 on page 1-6). A list of specific causes are described in Table 6-2.

Table 6-2 Fault Cause/Action.

Cause	Action
Microprocessor reset occurring on some module (probable circuit failure).	Cycle power. Call Qualified Service Technician.
Unplugged Convector Gauge.	Plug in gauge.
Sensor broken in Convector Gauge.	Replace gauge.
Convector Gauge zero badly out of calibration.	Adjust zero calibration. See Section 4.8 on page 4-22.
Checksum failure on Process Control board.	Cycle power and check all setpoints.

6.4 Overpressure Shutdown

As pressure increases, the ion current to the collector increases until the high density of gas molecules begins to interfere with the ionization process. When some electrons cannot acquire sufficient energy to ionize the gas molecules, the collector current no longer increases with increasing pressure. This pressure is called the “turn around” pressure. Further pressure increases will result in a decreasing ion current.

The Stabil-Ion Controller is factory set so the ion gauge will shut down when the pressure rises above the overpressure setpoint pressures shown in Table 6-3.

For reliable operation in general applications, the overpressure shutdown point is factory set below the Stabil-Ion Gauge turn around point at both emission currents. **Although we strongly recommend that you do not change the factory settings**, the overpressure shutdown can be readjusted for specific applications according to the following procedure.



Caution: If the overpressure shutdown point is increased from the factory settings, an excess pressure rise may go undetected—resulting in possible gauge and/or vacuum system damage. Consult factory if in doubt.

Table 6-3 Overpressure Shutdown Factory Settings.

Pressure Range	Overpressure Point (Torr)
H	2×10^{-2}
L	5×10^{-4}

To adjust the overpressure shutdown point to a different level:

1. Rotate the overpressure adjustment potentiometer clockwise several turns until the overrun clutch clicks.
2. Turn on the ion gauge.
3. Maintain system pressure at the desired shutdown point.

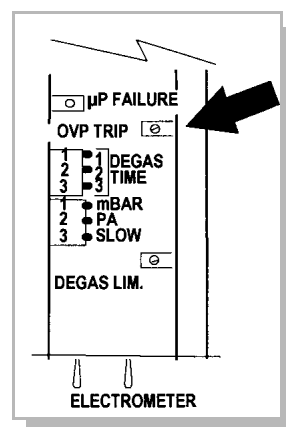

Figure 6-2 Electrometer Module, Top View Showing Overpressure Trip Adjust.

4. Rotate the adjustment pot counter-clockwise slowly until the IG turns off.

6.5 Electrometer Minimum Calibration Adjustment

This test and adjustment should only be done with the cover on and securely fastened to the Control Unit. This adjustment is used to cancel residual input currents so that the logarithmic electrometer amplifier is accurate in its lowest decades. It performs the same function as the zero adjustment on a conventional electrometer even though there is no zero reading on a log amplifier. It is factory set by calibrating the pressure readout to correspond to a very small collector input current. It can be checked in the field without a calibration source using the following procedure:

1. Verify that the scale factor is adjusted to 1.00.
2. Operate a Stabil-Ion Gauge with 4 mA emission (low pressure range).
3. Disconnect the collector lead from the rear panel of the electrometer module.
4. Observe the display for 10 seconds as it settles to a minimum reading. This reading should be between 2.50×10^{-11} and 2.75×10^{-11} Torr.
5. Locate the MIN. ADJ control on the rear panel of the Electrometer Module. See Figure 6-3.
6. Generate a display between 2.50×10^{-11} and 2.75×10^{-11} Torr by making very small adjustments of less than 1/4 turn at a time. It will be difficult to achieve a stable reading because of electronic noise at very low input currents. The optimum point is where the control causes the display to just switch to its minimum reading of 2.50×10^{-11} Torr.

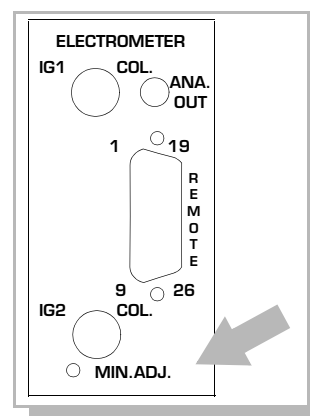

Figure 6-3 Rear View, Electrometer Module Showing MIN. ADJ Control.

6.6 Flashing Degas Light

If the DEGAS LED flashes when degassing with cathode 1 selected, but stays on continuously with cathode 2 selected, this is an indication that only cathode 1 is in poor condition and will eventually fail to maintain normal operating emission. When this occurs, the IG will fail to stay on with cathode 1 selected, and you will need to switch to cathode 2 for normal operation. If the same condition occurs after you have switched to cathode 2, it may indicate that the gauge needs to be replaced, or that there is a contamination source affecting both cathodes. See Step 6 on page 5-2 for more discussion.

6.7 Troubleshooting the Convectron Gauge Module

Table 6-4 Convectron Gauge Module Troubles.

Symptom	Possible Cause
Pressure reading grossly in error.	Controller out of calibration. Unknown gas type. Gauge not mounted horizontally (see Section 3.3 on page 3-3). Sensor damaged (e.g., by reactive gas). Gauge very dirty. Extremes of temperature or mechanical vibration.
CGA over current indicator lit.	Cable short, pins 1-3.
CGB over current indicator lit.	Cable short, pins 1-3.
Bridge circuit indicators lit.	Circuit failure.
CGA unplugged indicator lit.	CGA unplugged; open sensor wire.
CGB unplugged indicator lit.	CGB unplugged; open sensor wire.
Microprocessor reset LED lit or flashing.	Microprocessor failure.
A/D integration failure indicator lit or flashing.	Circuit failure.
Display reads blank.	Gauge unplugged; open sensor wire.

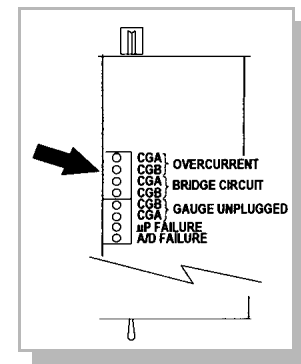

Figure 6-4 Convectron Module, Top View, Showing Trouble Indicator LED's.

6.8 Convectron Gauge Test Procedure

The small diameter sensor wire can be damaged by small voltages. Do not perform electrical continuity tests with instruments applying in excess of 1 volt when the gauge is at vacuum, or 5 volts when at atmospheric pressure.

The Convectron Gauge should show the following resistances (pin numbers are embossed on the gauge base):

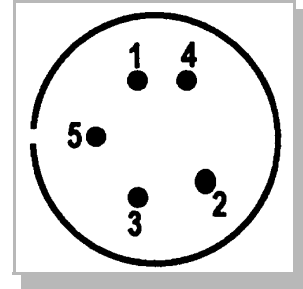

Table 6-5 Convectron Gauge Resistances.

Pressure Range	Overpressure Point (Torr)
Pins 1 to 2	20 to 25 ohms
Pins 2 to 3	50 to 60 ohms
Pins 1 to 5	175 to 190 ohms

Figure 6-5 Convectron Gauge Base.

If the resistance from pin 1 to pin 2 is about 800 ohms, the sensor wire is open.

6.9 Cleaning Contaminated Convectron Gauges



The fumes from solvents such as trichloroethylene, perchlorethylene, toluene, and acetone can be dangerous to health if inhaled. If used, use only in well-ventilated area exhausted to the outdoors. Acetone and toluene are highly flammable and should not be used near an open flame or energized electrical equipment.

The Convectron Gauge may be baked to 150 °C nonoperating while under vacuum with the Connector removed.

All materials have been chosen for ultra high vacuum service, corrosion resistance and bakeability. The envelope is type 304 stainless steel. All metallic joints in the envelope are TIG welded. No solder is used within the envelope. The following materials are exposed to the vacuum: Type 304 stainless steel, Carpenter Alloy 52, Kovar, Kapton, gold plated tungsten, borosilicate glass and Dow-Corning 9015 glass. The blue trim cover is rated at 150 ° C.

When the small sensor wire is contaminated with oil or other films, its emissivity or its diameter may be appreciably altered and a change of calibration will result. Cleaning with trichloroethylene, perchloroethylene, toluene, or acetone is possible but it must be done very carefully so as not to damage the sensor.

Hold the gauge with the main body horizontal and the port projecting upward at an angle of 45°. Slowly fill it with solvent using a standard wash bottle with the spout inserted in the port to where it touches the screen. Let the solvent stand in the gauge for at least ten minutes. **Do not shake the gauge.** Shaking the gauge with liquid inside can damage the sensor wire. To drain the gauge, position it horizontally with the port facing downward. Slightly warming the gauge will help dry the gauge. Then allow the gauge to dry overnight with the port vertically downward and uncapped. Before reinstalling the gauge on the system, be certain no solvent odor remains.

6.10 Process Control Troubleshooting

If the μ P FAILURE LED is lit or flashing (see Figure 6-6), there is a probable circuit failure. Return this product to a service facility designated by G-P for repair.

The setpoints are read from non-volatile memory into RAM when the unit powers up. On power up, a checksum is computed and stored in RAM, and is updated whenever a setpoint is changed. It is then periodically re-computed from the existing setpoints and checked against the pre-existing value. If for any reason (such as a power fluctuation or electrical transient in the system) a setpoint becomes corrupted, this method will trap the error. If this occurs the fault relay will be released if the Remote Input/Output Module is installed and will remain released until power is cycled on the 360 Control Unit.

If a setpoint is found to contain garbled data which cannot be interpreted as a valid setpoint, it will be set to 0, and the fault relay, if present, released.

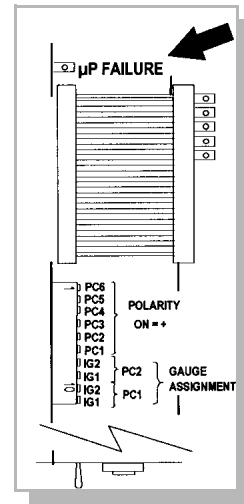

Figure 6-6 Process Control Module, Top View, Showing μ P Failure LED.

6.11 RS-232 Troubleshooting

Because the RS-232 “standard” is found in a bewildering array of configurations, the first thing to do if trouble arises is check the following configuration options:

1. Check switch settings.

Be sure baud rate, character format and framing, and interface protocol are matched to your host computer or terminal's requirements. Note that there may be several mismatched parameters. Check to see if your computer requires the reversed-polarity RTS convention.

2. Check interface wiring.

The pin designations for the RS-232 connector are shown in Table 3-4 on page 3-14. Note that the “received” and “transmitted” data lines are defined as seen by the 360 Control Unit. Many companies supply “null modems” or switch boxes for the purpose of re-configuring the control lines for particular applications.

3. Check command format.

Be sure the strings you output to the 360 are in accord with the syntax defined in Section 4.11 on page 4-25.

Table 6-6 RS-232 Troubleshooting Guide.

Symptom	Possible Cause
Micro-controller reset LED lit or flashing.	Micro-controller failure.
No response or garbled output.	Baud rate incorrect. Character length incorrect or stop bit(s) incorrect. Faulty cable.
OVERRUN ERROR message.	Stop bit(s) incorrect, host software failure.
PARITY ERROR message.	Parity incorrect.
SYNTAX ERROR message.	Message to 360 not in accord with specified syntax. Could also result from failure to assert DCD handshake line.

6.12 RS-485 Troubleshooting

In the event of problems with the RS-485 communications verify the following items for proper configuration.

1. Check configuration switch settings.

Ensure the baud rate, character framing, and interface protocol are matched to the host computer or terminal's requirements. Note that there may be several mismatched parameters.

2. Check command format.

Ensure that the command strings output from the host computer or terminal to the Series 360 Controller are in accordance with the syntax defined by this addendum.

Table 6-7 RS-485 Troubleshooting Guide

Symptom	Possible Cause
Micro-controller reset LED CR1 illuminated or flashing	Micro-controller failure.
No response or garbled output	Baud rate incorrect, character length incorrect, character framing incorrect, or bias resistors do not exist or are incorrect.
Intermittently will not respond	Poor cable connections, ground fluctuations (the maximum common mode potential across the system is 7 volts) and EMI from other sources. Bias resistors do not exist or are incorrect. If the start character is not received properly, the Series 360 controller may not interpret it as a start character and the controller will not respond. Host software must be prepared to re-send a command if a response is not generated within a reasonable period of time.
OVERRUN ERROR message	Stop bit(s) incorrect, host software failure.
PARITY ERROR message	Parity incorrect.
SYNTAX ERROR message	Message to 360 Controller not in accord with specified syntax.

6.13 IEEE 488 Troubleshooting

If your interface fails to function, first verify the following:

1. Switch settings.

Be sure the vacuum system controller knows the address of the 360 as set by the dip switches. Be sure the vacuum system controller does not reserve certain addresses for system devices, e.g., a printer. Be sure the 360 is not in the talk-only mode unless desired for data logging. Be sure, if the SRQ mode is set, that your controller performs a serial poll in response to the SRQ from the 360.

2. Check interface wiring.

Be sure the cable is good; try swapping in a known good cable (IEEE 488 cables are available from G-P). Check for too many devices on the bus or too great a total bus length (> 20 meters). Too many devices could cause problems due to capacitive loading.

3. Check command syntax.

Be sure you are following the syntax specified in Section 4.13 on page 4-32.

Table 6-8 IEEE 488 Troubleshooting Guide.

Symptom	Possible Cause
Micro-controller reset LED lit.	Micro-controller failure.
OVERRUN ERROR message.	Host software failure.
SYNTAX ERROR message.	Message to 360 not in accord with syntax.
No response.	Incorrect address setting. Faulty cable.

6.14 Field Installation of Modules

- 1. Turn off power.**
- 2. With power off, remove any cables from the Control Unit rear panel.**
- 3.** Observe antistatic precautions to avoid damaging static sensitive components inside the chassis. Use a grounded, conductive work surface. Do not handle MOS devices more than absolutely necessary, and only when wearing a high impedance ground strap. Use conductive envelopes to store or ship MOS devices or printed circuit boards. Do not operate the 360 Controller with MOS devices removed from the printed circuit boards.
- 4.** See Section 2.1.1 on page 2-2 for how to remove the top cover.
- 5.** Locate correct position for module.
- 6.** Carefully remove the bus ribbon cable from all modules located to the right (as you face the front panel) of the position where the module is to be installed. Remove connectors slowly using pull tabs.
- 7.** Lift out the filler module at the position where the module is to be installed.
- 8.** Install the module in its proper position making sure all ends lock together.
- 9.** Carefully reconnect the bus ribbon connectors.
- 10.** Select appropriate switch settings. See Chapter 2.
- 11.** Replace the top cover as directed in Section 2.1.9 on page 2-17.

6.15 Troubleshooting Flow Charts

Table 6-9 Troubleshooting Flow Charts.

Fig. No.	Description	Fig. No.	Description
Figure 6-7	Power Turn On.	Figure 6-10	Convectron Gauge Display.
Figure 6-8	Stabil-Ion Gauge Turn On.	Figure 6-11	RS-232/IEEE 488 Interface.
Figure 6-9	Stabil-Ion Gauge Display.		

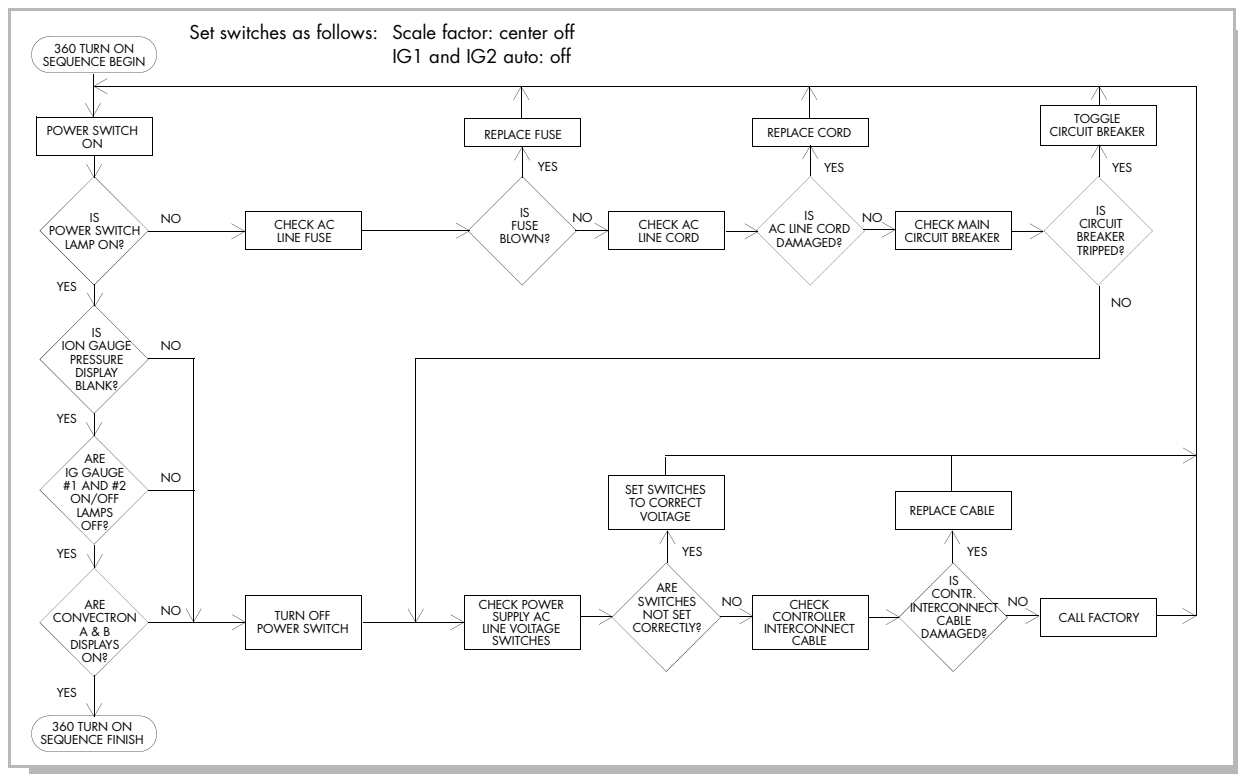

Figure 6-7 Power Turn On.

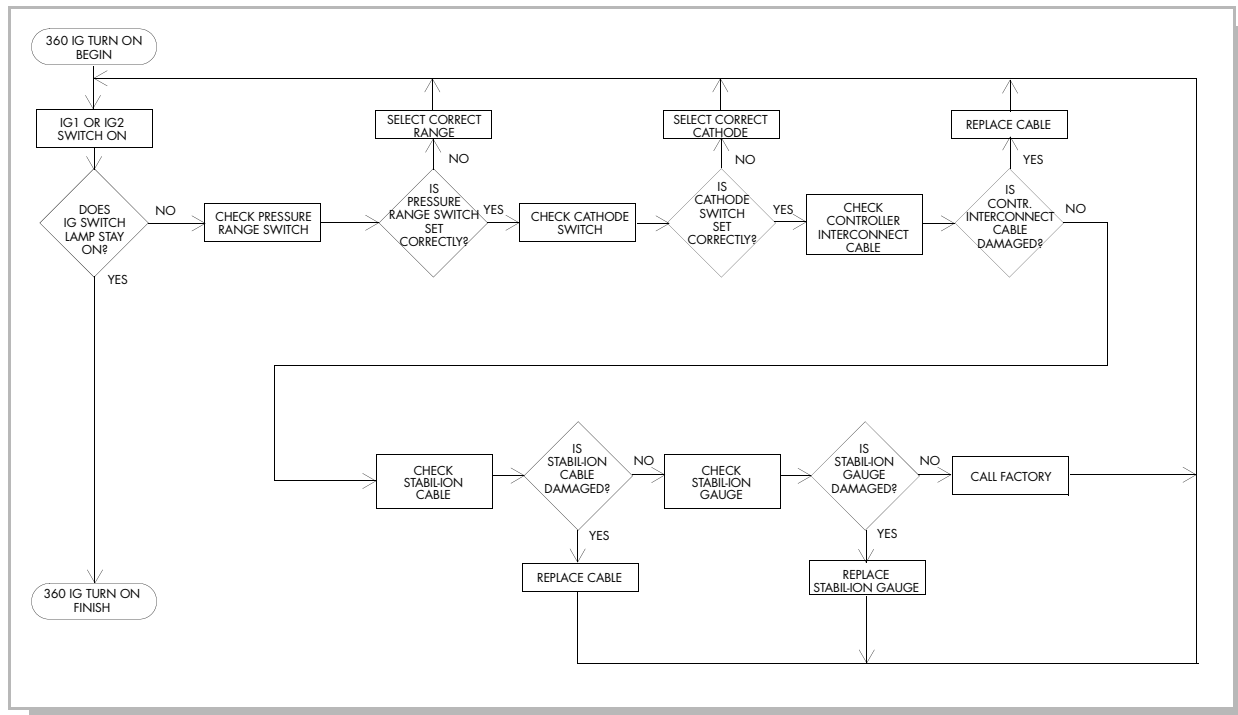

Figure 6-8 Stabil-Ion Gauge Turn On.

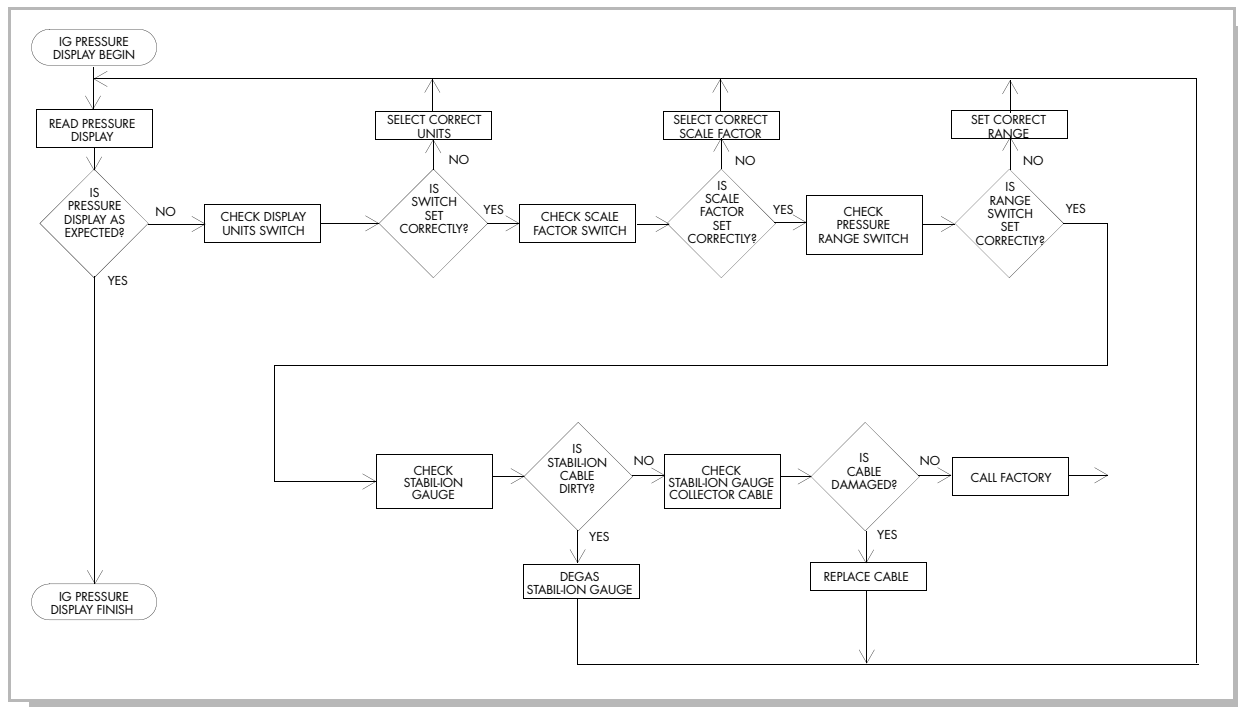

Figure 6-9 Stabil-Ion Gauge Display.

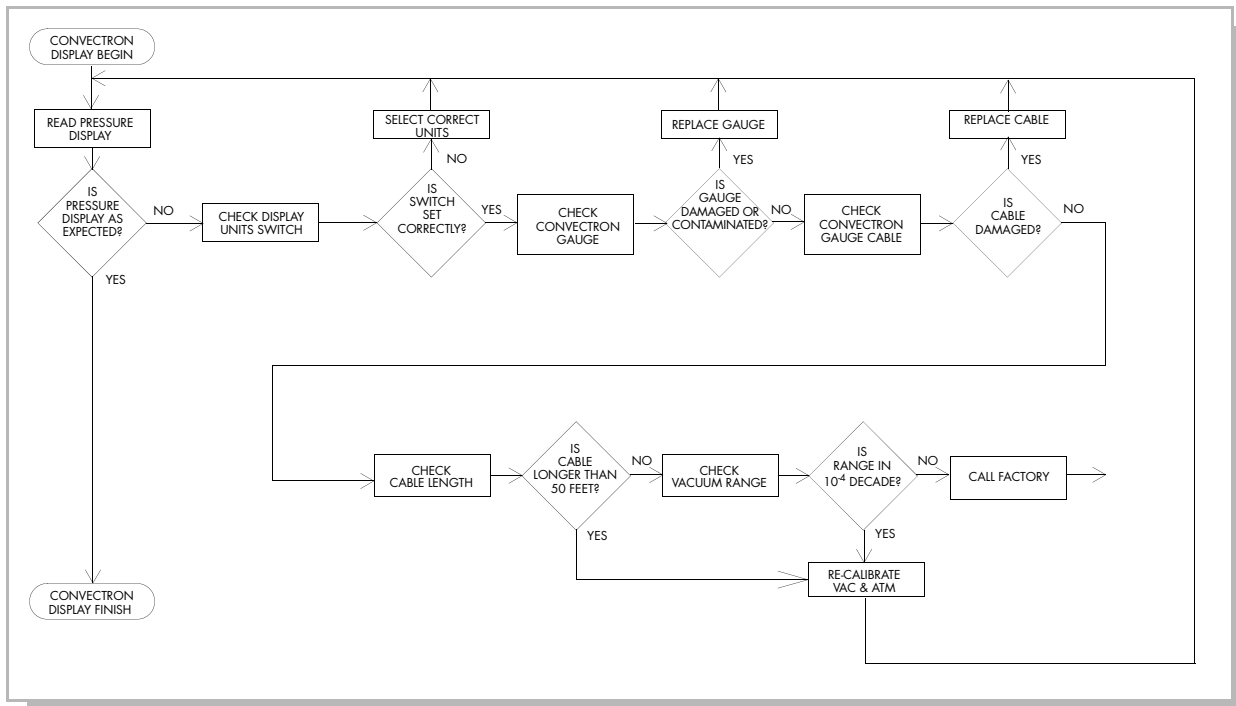

Figure 6-10 Convectron Gauge Display.

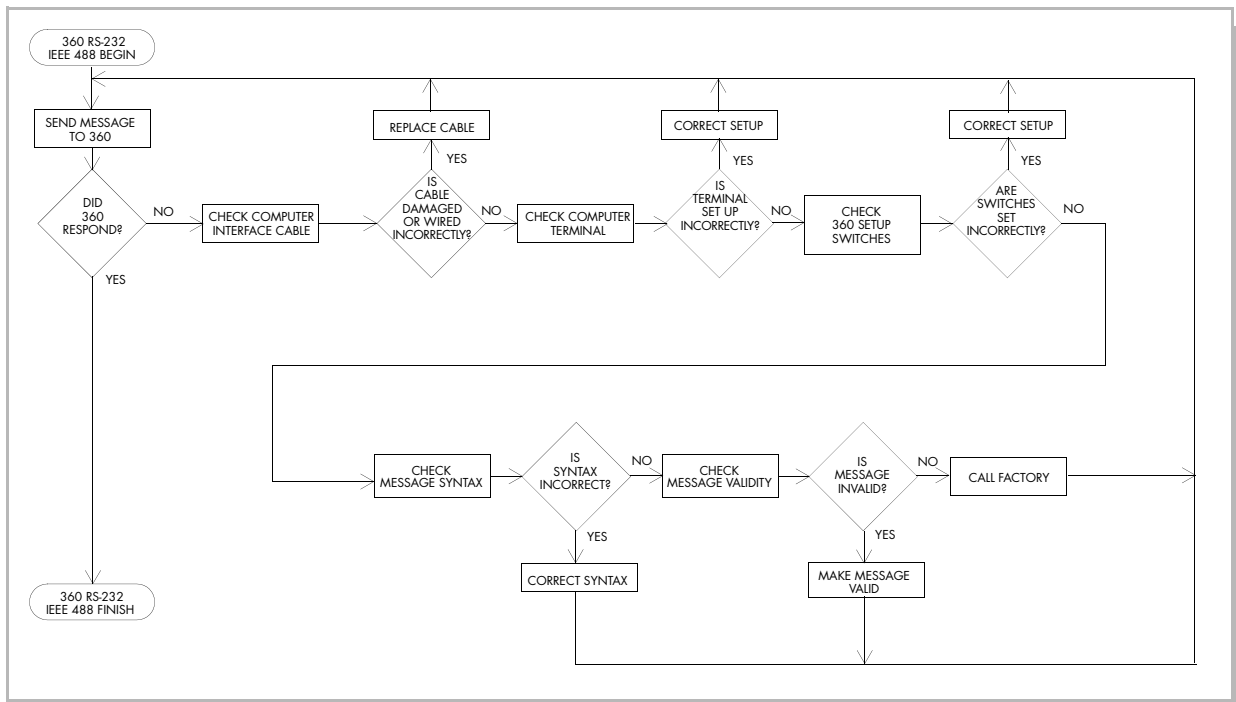

Figure 6-11 RS-232/IEEE 488 Interface.

A

- AC line voltage
 - Between 180V to 240V **2-18**
 - Between 90V to 130V **2-17**
- Analog output
 - CONVECTRON Gauge
 - Connecting **3-7**
 - STABIL-ION Gauge
 - Connecting **3-7**

B

- Bus address **2-15**
- Byte format **2-10**

C

- Cable installation statement **3-1**
- Cathode **4-2**
- Certification, product **1-ix**
- Command syntax
 - IEEE 488 **4-32**
 - RS-232 **4-26**
- Connector
 - STABIL-ION Gauge **3-19**
- Control Unit
 - Drawing **1-2, 1-4, 1-6**
 - Mounting **3-5**
 - Removing top cover **2-2**
 - Set up **2-1**
- CONVECTRON Gauge
 - Analog output - connecting **3-7**
 - Cleaning Contaminated
 - Convector Gauges **6-8**
 - Gases other than nitrogen or air **4-12**
 - Installation **3-3**
 - Mounting **3-3**
 - Operation **4-11, 5-1**
 - Pressure measurement **4-11**
 - Test Procedure **6-8**
 - Vacuum connections **3-4**
 - Zero and atmospheric indications **4-22**

D

- DA-26P Connector **3-11**
- Damage requiring service safety **1-vi**
- Degas
 - Flashing light **5-2**

- Power timer **2-16**
- Display formats **5-1**
- Drawings
 - Control Unit
 - Front panel **1-2, 1-3**
 - Rear panel **1-4**
 - Top view **1-6**
 - Power Supply **1-5**
 - Six channel Process Control **2-6**
 - STABIL-ION Gauge **3-20**
 - Two channel Process Control **2-6**

E

- EMC compliance **3-1**
- Environmental conditions **3-2**

F

- FCC verification **1-ix**
- Field Installation of Modules **6-11**
- Flow Charts
 - Troubleshooting **6-12**

G

- Gases other than nitrogen or air **4-4, 4-12**
- Grounding the system **3-5**
- Guard **3-19**

H

- Handshaking **2-11**

I

- IEEE 488
 - Command syntax **4-32**
 - Computer interface setup **2-15**
 - Connecting **3-18**
 - SRQ mode **2-16**
 - Talk-only mode **2-15**
 - Troubleshooting **6-10**
- IG Process Control channel switch settings **2-7**
- Installation **3-1**
 - CONVECTRON Gauge **3-3**
 - Grounding the system **3-5**
 - STABIL-ION Gauge **3-2**
 - Tips **3-1**

M

- Memory module
 - Stabil-Ion Gauge **4-8**
- Mounting
 - Control Unit **3-5**
 - Control Unit and Power Supply **3-6**
 - CONVECTRON Gauge **3-3**
 - Hardware for **1-2**
 - Power Supply **3-5**

O

- Operation
 - CONVECTRON Gauge **4-11, 5-2**
 - Stabil-Ion Gauge **4-1**
 - STABIL-ION System **5-1**
- Overpressure Shutdown **6-5**

P

- Power cables **3-21**
- Power Supply
 - Mounting **3-5**
 - Set up **2-17**
- Pressure measurement
 - CONVECTRON Gauge **4-11**
 - Stabil-Ion Gauge **4-1**
- Pressure range **4-2**
- Pressure units
 - Display formats **5-1**
- Process Control
 - Connecting relays **3-8**
 - Preparation for operation **4-24**
 - Setpoint display and adjustment **4-24**
 - Setup **2-5**
 - Tips **2-9**

R

- Relay polarity setting **2-8, 2-14**
- Remote Control
 - IG on/off **3-11**
 - Input states **3-10**
 - output connector **3-13**
 - Pressure range **3-12**
 - STABIL-ION Gauge **3-9**
- RS-232
 - Command syntax **4-26**
 - Computer interface setup **2-9**

- Connecting **3-13**
 - Troubleshooting **6-9**
 - RS-485
 - Address **2-13**
 - Baud Rate **2-13**
 - Byte Format **2-13**
 - Character Framing **2-14**
 - Character framing switch settings **2-14**
 - Computer Interface Setup **2-12**
 - Computer Interface-connecting **3-16**
 - Factory defaults **2-12**
 - Troubleshooting **6-10**
- S**
- Safety
 - damage requiring service **1-vi**
 - instructions **1-v**
 - Scale factor **4-2, 4-4**
 - Service form **6-15**
 - Service guidelines **1-ix, 6-1**
 - Setpoint display and adjustment
 - Process Control **4-24**
 - Stabil-Ion
 - Gases other than nitrogen or air **4-4**
 - STABIL-ION Gauge
 - Cables **3-19**
 - Connector **3-1, 3-19**
 - Guard **3-19**
 - Installation **3-2**
 - Picture **1-1**
 - Stabil-Ion Gauge
 - Alternate on/off **4-3**
 - Analog output - connecting **3-7**
 - Gas scale factor **4-4**
 - Operation **4-1**
 - Pressure measurement **4-1**
 - Pressure range settings **4-2**
 - STABIL-ION System
 - Operation **5-1**
- T**
- Tips
 - Installation **3-1**
 - Process Control **2-9**
 - Top cover
 - Removing **2-2**
 - Troubleshooting
 - Convectron Gauge Module **6-7**
 - Flow Charts **6-12**
 - IEEE 488 **6-10**
 - RS-232 **6-9**
 - RS-485 **6-10**
- V**
- Vacuum connections **3-4**
- W**
- Warranty **1-ix**

Series 360

Granville-Phillips® Series 360 Stabil-Ion® Vacuum Measurement Controller



For Customer Service or Technical Support 24 hours per day,
7 days per week, every day of the year including holidays:
Phone: +1-800-227-8766 or +1-303-652-4691

MKS, Granville-Phillips Division

6450 Dry Creek Parkway
Longmont, CO 80503 USA

Phone: 1-303-652-4691 or 1-800-776-6543

FAX: 1-303-652-2844

Email: gp-csr@mksinst.com

Corporate Office

MKS Instruments, Inc.

2 Tech Drive, Suite 201
Andover, MA 01810 USA

Phone: 1-978-645-5500

www.mksinst.com

Instruction Manual

Instruction manual part number 360119

Revision A - September 2014