



115605-P1
Rev F, 10/97
Instruction Manual

MKS Type 651C Pressure Controller



WARRANTY

Type 651C Equipment

MKS Instruments, Inc. (**MKS**) warrants that the equipment described above (the "equipment") manufactured by **MKS** shall be free from defects in materials and workmanship for a period of one year from date of shipment and will for a period of two years from the date of shipment, correctly perform all date-related operations, including without limitation accepting data entry, sequencing, sorting, comparing, and reporting, regardless of the date the operation is performed or the date involved in the operation, provided that, if the equipment exchanges data or is otherwise used with equipment, software, or other products of others, such products of others themselves correctly perform all date-related operations and store and transmit dates and date-related data in a format compatible with **MKS** equipment. **THIS WARRANTY IS MKS' SOLE WARRANTY CONCERNING DATE-RELATED OPERATIONS.**

For the period commencing with the date of shipment of this equipment and ending one year later in the case of defects in materials and workmanship, but two years later in the case of failure to comply with the date-related operations warranty, **MKS** will, at its option, either repair or replace any part which is defective in materials or workmanship or with respect to the date-related operations warranty without charge to the purchaser. The foregoing shall constitute the exclusive and sole remedy of the purchaser for any breach by **MKS** of this warranty.

The purchaser, before returning any equipment covered by this warranty, which is asserted to be defective by the purchaser, shall make specific written arrangements with respect to the responsibility for shipping the equipment and handling any other incidental charges with the **MKS** sales representative or distributor from which the equipment was purchased or, in the case of a direct purchase from **MKS**, with the **MKS** home office in Andover, Massachusetts, USA.

This warranty does not apply to any equipment which has not been installed and used in accordance with the specifications recommended by **MKS** for the proper and normal use of the equipment. **MKS** shall not be liable under any circumstances for indirect, special, consequential, or incidental damages in connection with, or arising out of, the sale, performance, or use of the equipment covered by this warranty.

MKS recommends that all **MKS** pressure and flow products be calibrated periodically (typically every 6 to 12 months) to ensure accurate readings. When a product is returned to **MKS** for this periodic re-calibration it is considered normal preventative maintenance not covered by any warranty.

THIS WARRANTY IS IN LIEU OF ALL OTHER RELEVANT WARRANTIES, EXPRESSED OR IMPLIED, INCLUDING THE IMPLIED WARRANTY OF MERCHANTABILITY AND THE IMPLIED WARRANTY OF FITNESS FOR A PARTICULAR PURPOSE, AND ANY WARRANTY AGAINST INFRINGEMENT OF ANY PATENT.

MKS Type 651C Pressure Controller

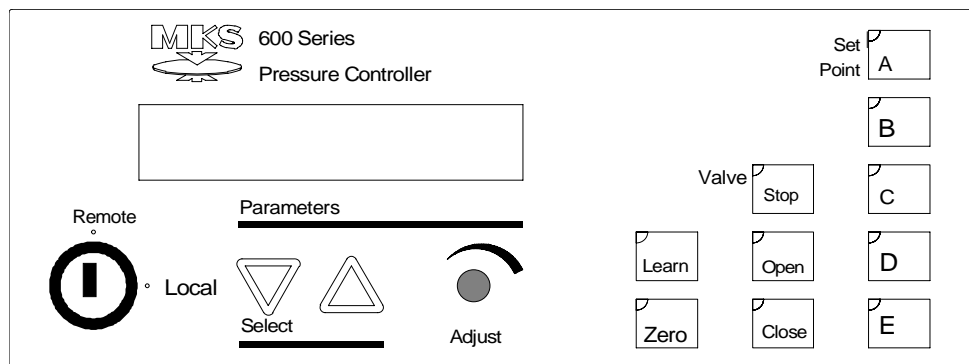

Please Note:

MKS Instruments provides these documents as the latest version for the revision indicated. The material is subject to change without notice, and should be verified if used in a critical application.

Copyright © 1997 by MKS Instruments, Inc.

All rights reserved. No part of this work may be reproduced or transmitted in any form or by any means, electronic or mechanical, including photocopying and recording, or by any information storage or retrieval system, except as may be expressly permitted in writing by MKS Instruments, Inc.

Baratron® is a registered trademark of MKS Instruments, Inc., Andover, MA

This manual is for firmware version 1.8x

Table of Contents

Safety Information.....	1
Symbols Used in This Instruction Manual.....	1
Symbols Found on the Unit	2
Safety Procedures and Precautions	3
Sicherheitshinweise	5
In dieser Betriebsanleitung vorkommende Symbole	5
Am Gerät angebrachte Symbole.....	6
Sicherheitsvorschriften und Vorsichtsmaßnahmen.....	7
Informations relatives à la sécurité.....	9
Symboles utilisés dans ce manuel d'utilisation	9
Symboles apparaissant sur l'appareil	10
Mesures de sécurité et mises en garde	11
Información sobre seguridad.....	13
Símbolos usados en el manual de instrucciones.....	13
Símbolos que aparecen en la unidad.....	14
Procedimientos y precauciones de seguridad	15
Chapter One: General Information.....	17
Introduction	17
How This Manual is Organized.....	18
Customer Support.....	19
Chapter Two: Installation	21
How To Unpack the Type 651 Unit	21
Unpacking Checklist.....	21
Product Location and Requirements.....	22
Operating Environmental Requirements	22
Safety Conditions.....	22
Setup	23
Environmental Requirements.....	23

Checking the Fuses and Line Voltage Selector Switch	24
How To Change the Line Voltage	25
Chapter Three: Overview	27
Front Panel.....	27
Front Panel Components.....	27
Front Panel Display	28
Local and Remote Operation.....	29
Command Priority	29
Control Mode: Self-Tuning or PID Control.....	29
Softstart Control	30
Battery Backups.....	30
Rear Panel.....	31
Rear Panel Components.....	31
Electrical Connections	32
Labels	38
Serial Number Label.....	38
Chapter Four: System Setup.....	39
Overview.....	39
RS-232 Commands and Requests	39
Valve Selection and Calibration.....	40
Setup Menu.....	41
Control Mode	41
RS-232 Communications	42
Sensor Setup.....	43
Analog Set Point.....	45
Valve Position Output.....	45
Set Points A Through E, Pressure/Position Selection	46
Softstart Rates.....	47
Valve Control	48
Chapter Five: Local Operation	49
Overview.....	49
How To View and Adjust Set Points	50

How To Activate Set Points	51
How To Identify an Out-of-Range Condition	51
How To Control the Valve	52
How To Open the Valve	52
How To Close the Valve	52
How To Halt the Valve	52
How To Activate the Learn Function	53
How To Stop the Learn Function	53
How To Zero a Sensor	54
How To Use Special Zero	54
How To Remove Zero	54
How To Set a Process Limit Relay	55
How To View and Adjust a Process Limit Relay	55
How To Disable a Process Limit Relay	55
How To View and Adjust the Analog Set Point	56
How To Zero the Analog Set Point	56
How To Calibrate Full Scale Span for the Analog Set Point	57
How To Set Lead and Gain Parameters	58
How To Calibrate Span of the A/D Converter	59
Chapter Six: Remote Operation	61
Overview	61
RS-232 Commands and Requests	61
Message Syntax	61
Priority of Command Execution	63
How To Change Valve Selection and Calibration	64
How To Determine and Change the Control Mode	65
How To Configure the Sensor Parameters	66
How To Change the Sensor Type	66
How To Change the Sensor Full Scale Voltage	66
How To Change the Sensor Range	67
How To Request the Pressure Reading	68
Converting Pressure Readings to Absolute Pressure Values	68
How To Zero a Sensor	69

How To Use the Special Zero	69
How To Remove the Zero.....	69
How To Activate the Learn Function.....	70
How To Stop the Learn Function	71
How To Determine the Active Set Point.....	72
How To Select the Active Set Point.....	73
How To Select Pressure or Position Control	74
How To Change the Set Point Value	75
How To Adjust the Analog Set Point Value.....	76
How To Set the Analog Set Point Full Scale Range	76
How To Zero the Analog Set Point	77
How To Learn Analog Set Point Full Scale.....	77
How To Set the Full Scale Level of the Analog Set Point	78
How To Calibrate Span of the A/D Converter.....	79
How To Respond To a Checksum Error	80
How To Set the Lead and Gain Parameters.....	81
How To Set The Softstart Control Rate	83
How To Set the Softstart Rate.....	83
How To Use the Softstart Rate.....	83
How To Check the Softstart Rate.....	84
How To Configure the Valve Parameters.....	85
How To Check the Valve Selected.....	85
How To Change and Calibrate the Valve	85
How To Change the Valve Position Output.....	86
How To Change the Valve Control Direction.....	86
How To Control the Valve	87
How To Open the Valve	87
How To Close the Valve.....	87
How To Halt the Valve	87
How To Set a Process Limit Relay	88
How To View and Adjust a Process Limit Relay.....	88
How To Disable a Process Limit Relay.....	88
How To Check the System Status.....	89

How To Check the Firmware Version	89
Digital Logic Control.....	90
I/O Board Digital Circuitry.....	90
Digital Input Priorities.....	92
Digital Functions.....	93
Analog Set Point Inputs.....	95
Chapter Seven: Battery-Backed Memory Module	97
Replacing the Battery-Backed Memory Module.....	97
Opening the Unit.....	97
Removing the CPU Board and Memory Module	98
Installing a New Memory Module and Replacing the CPU Board.....	99
Replacing the Cover	99
Chapter Eight: Valve Failsafe Battery Back-up Option	101
General Information.....	101
Battery Voltage.....	102
Valve Positions.....	102
Startup.....	103
Threshold Voltage Check	103
Battery Voltage Within Range.....	103
Battery Voltage Out-of-Range	104
Operation.....	105
How To Check the Battery Voltage	105
How To Set The Battery Back-up Valve Control.....	106
Expected Battery Life	108
Battery Storage	108
Battery Replacement.....	109
Opening the Unit.....	109
Installing the New Battery	110
Chapter Nine: Maintenance	111
General Information.....	111
How To Replace Fuses	111
Appendix A: Product Specifications	113

Appendix B: Model Code Explanation.....	115
Model Code	115
Appendix C: Product Compatibility	117
Product Compatibility	117
Valves	117
Transducers	117
Adapter Cables	118
Appendix D: Type 651 Displayless Unit.....	119
Type 651 Displayless Unit	119
RS-232 Configuration	120
Internal Switches	120
Opening/Closing the 651 Controller.....	120
Dipswitch Bank Settings.....	122
Appendix E: Initial Settings.....	125
Appendix F: Command and Request Reference.....	127
Command Reference	127
Request and Response Reference.....	134
Index	141

List of Figures

Figure 1: Voltage and Fuse Data for the Low Power Unit.....	25
Figure 2: Voltage and Fuse Data for the High Power Unit.....	26
Figure 3: Front Panel of the 651 Instrument.....	27
Figure 4: Rear Panel of the 651 Instrument.....	31
Figure 5: Serial Number Label	38
Figure 6: I/O Board Digital Input Circuitry.....	90
Figure 7: I/O Board Digital Output Circuitry	91
Figure 8: Location of the Battery-backed RAM Module	98
Figure 9: Initial Display Screen	103
Figure 10: Default Pressure and Position Screen.....	103
Figure 11: Battery Voltage Low Message.....	104
Figure 12: Battery Voltage High Message	104
Figure 13: Fuse Holder.....	112
Figure 14: Front Panel of the 651 Displayless Unit.....	119
Figure 15: Dipswitch Bank Location (Top View)	121
Figure 16: Example of Dipswitch Bank	121

List of Tables

Table 1: Definition of Symbols Found on the Unit	2
Tabelle 2: Definitionen der am Gerät angebrachten Symbole	6
Tableau 3 : Définition des symboles apparaissant sur l'appareil	10
Tabla 4 : Definición de los símbolos que aparecen en la unidad.....	14
Table 5: Fuse Information	24
Table 6: Summary of Front Panel Components.....	28
Table 7: Slot Labels	31
Table 8: Serial RS-232 Interface Connector Pinout.....	32
Table 9: RS-232 Serial Communication Cables	33
Table 10: I/O Connector Pinout.....	34
Table 11: Transducer Connector Pinout.....	36
Table 12: System Interface Cables for MKS Transducers	36
Table 13: Valve Connector Pinout.....	37
Table 14: System Interface Cables for MKS Throttle Valves	37
Table 15: Sensor Range Values	67
Table 16: Priority of Digital Inputs.....	92
Table 17: Digital Input Functions	93
Table 18: Digital Output Functions	95
Table 19: Expected Battery Life	108
Table 20: Capacity Loss of Stored Battery.....	108
Table 21: Transducer Current Available from Low and High Power Units.....	117
Table 22: 651 Adapter Cables.....	118
Table 23: Default Dipswitch Settings	122
Table 24: I/O Board Dipswitch Bank and RS-232 Communications Settings.....	123
Table 25: Initial Settings	125
Table 26: RS-232 Command Summary	128
Table 27: RS-232 Request and Response Summary	134

Safety Information

Symbols Used in This Instruction Manual

Definitions of WARNING, CAUTION, and NOTE messages used throughout the manual.

Warning



The **WARNING** sign denotes a hazard. It calls attention to a procedure, practice, condition, or the like, which, if not correctly performed or adhered to, could result in injury to personnel.

Caution



The **CAUTION** sign denotes a hazard. It calls attention to an operating procedure, practice, or the like, which, if not correctly performed or adhered to, could result in damage to or destruction of all or part of the product.

Note



The **NOTE** sign denotes important information. It calls attention to a procedure, practice, condition, or the like, which is essential to highlight.

Symbols Found on the Unit

The following table describes symbols that may be found on the unit.















Definition of Symbols Found on the Unit			
 On (Supply) IEC 417, No.5007	 Off (Supply) IEC 417, No.5008	 Earth (ground) IEC 417, No.5017	 Protective earth (ground) IEC 417, No.5019
 Frame or chassis IEC 417, No.5020	 Equipotentiality IEC 417, No.5021	 Direct current IEC 417, No.5031	 Alternating current IEC 417, No.5032
 Both direct and alternating current IEC 417, No.5033-a	 Class II equipment IEC 417, No.5172-a	 Three phase alternating current IEC 617-2 No.020206	
 Caution, refer to accompanying documents ISO 3864, No.B.3.1	 Caution, risk of electric shock ISO 3864, No.B.3.6	 Caution, hot surface IEC 417, No.5041	

Table 1: Definition of Symbols Found on the Unit

Safety Procedures and Precautions

The following general safety precautions must be observed during all phases of operation of this instrument. Failure to comply with these precautions or with specific warnings elsewhere in this manual violates safety standards of intended use of the instrument and may impair the protection provided by the equipment. MKS Instruments, Inc. assumes no liability for the customer's failure to comply with these requirements.

DO NOT SUBSTITUTE PARTS OR MODIFY INSTRUMENT

Do not install substitute parts or perform any unauthorized modification to the instrument. Return the instrument to an MKS Calibration and Service Center for service and repair to ensure that all safety features are maintained.

SERVICE BY QUALIFIED PERSONNEL ONLY

Operating personnel must not remove instrument covers. Component replacement and internal adjustments must be made by qualified service personnel only.

GROUNDING THE PRODUCT

This product is grounded through the grounding conductor of the power cord. To avoid electrical shock, plug the power cord into a properly wired receptacle before connecting it to the product input or output terminals. A protective ground connection by way of the grounding conductor in the power cord is essential for safe operation.

DANGER ARISING FROM LOSS OF GROUND

Upon loss of the protective-ground connection, all accessible conductive parts (including knobs and controls that may appear to be insulating) can render an electrical shock.

GROUND AND USE PROPER ELECTRICAL FITTINGS

Dangerous voltages are contained within this instrument. All electrical fittings and cables must be of the type specified, and in good condition. All electrical fittings must be properly connected and grounded.

USE THE PROPER POWER CORD

Use only a power cord that is in good condition and which meets the input power requirements specified in the manual.

Use only a detachable cord set with conductors that have a cross-sectional area equal to or greater than 0.75 mm². The power cable should be approved by a qualified agency such as VDE, Semko, or SEV.

USE THE PROPER POWER SOURCE

This product is intended to operate from a power source that does not apply more voltage between the supply conductors, or between either of the supply conductors and ground, than that specified in the manual.

USE THE PROPER FUSE

Use only a fuse of the correct type, voltage rating, and current rating, as specified for your product.

DO NOT OPERATE IN EXPLOSIVE ATMOSPHERES

To avoid explosion, do not operate this product in an explosive environment unless it has been specifically certified for such operation.

HIGH VOLTAGE DANGER

High voltage is present in the cable, and in the sensor when the controller is turned on.

Sicherheitshinweise

In dieser Betriebsanleitung vorkommende Symbole

Definition der mit WARNUNG!, VORSICHT! und HINWEIS überschriebenen Abschnitte in dieser Betriebsanleitung.

Warnung!



Das Symbol **WARNUNG!** weist auf eine Gefahrenquelle hin. Es macht auf einen Arbeitsablauf, eine Arbeitsweise, einen Zustand oder eine sonstige Gegebenheit aufmerksam, deren unsachgemäße Ausführung bzw. ungenügende Berücksichtigung zu Körperverletzung führen kann.

Vorsicht!



Das Symbol **VORSICHT!** weist auf eine Gefahrenquelle hin. Es macht auf einen Bedienungsablauf, eine Arbeitsweise oder eine sonstige Gegebenheit aufmerksam, deren unsachgemäße Ausführung bzw. ungenügende Berücksichtigung zu einer Beschädigung oder Zerstörung des Produkts oder von Teilen des Produkts führen kann.

Hinweis



Das Symbol **HINWEIS** weist auf eine wichtige Mitteilung hin, die auf einen Arbeitsablauf, eine Arbeitsweise, einen Zustand oder eine sonstige Gegebenheit von besonderer Wichtigkeit aufmerksam macht.

Am Gerät angebrachte Symbole

Der untenstehenden Tabelle sind die Bedeutungen der Symbole zu entnehmen, die an dem Gerät angebracht sind.















Definitionen der am Gerät angebrachten Symbole			
			
Ein (Netz) IEC 417, Nr. 5007	Aus (Netz) IEC 417, Nr. 5008	Erde IEC 417, Nr. 5017	Schutzleiter IEC 417, Nr. 5019
			
Rahmen oder Chassis IEC 417, Nr. 5020	Äquipotentialanschluß IEC 417, Nr. 5021	Gleichstrom IEC 417, Nr. 5031	Wechselstrom IEC 417, Nr. 5032
			
Wechselstrom und Gleichstrom IEC 417, Nr. 5033-a	Geräteklasse II IEC 417, Nr. 5172-a	Drehstrom IEC 617-2 Nr. 020206	
			
Vorsicht! Bitte Begleitdokumente lesen! ISO 3864, Nr. B.3.1	Vorsicht! Stromschlaggefahr! ISO 3864, Nr. B.3.6	Vorsicht! Heiße Fläche! IEC 417, Nr. 5041	

Tabelle 2: Definitionen der am Gerät angebrachten Symbole

Sicherheitsvorschriften und Vorsichtsmaßnahmen

Die untenstehenden allgemeinen Sicherheitsvorschriften sind bei allen Betriebsphasen dieses Instruments zu befolgen. Jede Mißachtung dieser Sicherheitsvorschriften oder sonstiger spezifischer Warnhinweise in dieser Betriebsanleitung stellt eine Zuwiderhandlung der für dieses Instrument geltenden Sicherheitsstandards dar und kann die an diesem Instrument vorgesehenen Schutzvorrichtungen unwirksam machen. MKS Instruments, Inc. haftet nicht für eine Mißachtung dieser Sicherheitsvorschriften seitens des Kunden.

Keine Teile austauschen und keine Veränderungen vornehmen!

Bauen Sie in das Instrument keine Ersatzteile ein, und nehmen Sie keine eigenmächtigen Änderungen am Gerät vor! Schicken Sie das Instrument zu Wartungs- und Reparaturzwecken an einen MKS-Kalibrierungs- und -Kundendienst ein! Dadurch wird sichergestellt, daß alle Sicherheitseinrichtungen voll funktionsfähig bleiben.

Wartung nur durch qualifizierte Fachleute!

Das Gehäuse des Instruments darf vom Bedienpersonal nicht geöffnet werden. Das Auswechseln von Bauteilen und das Vornehmen von internen Einstellungen ist nur von qualifizierten Fachleuten durchzuführen.

Produkt erden!

Dieses Produkt ist mit einer Erdleitung und einem Schutzkontakt am Netzstecker versehen. Um der Gefahr eines elektrischen Schlages vorzubeugen, ist das Netzkabel an einer vorschriftsmäßig geerdeten Schutzkontaktsteckdose anzuschließen, bevor es an den Eingangs- bzw. Ausgangsklemmen des Produkts angeschlossen wird. Das Instrument kann nur sicher betrieben werden, wenn es über den Erdleiter des Netzkabels und einen Schutzkontakt geerdet wird.

Gefährdung durch Verlust der Schutzerdung!

Geht die Verbindung zum Schutzleiter verloren, besteht an sämtlichen zugänglichen Teilen aus stromleitendem Material die Gefahr eines elektrischen Schlages. Dies gilt auch für Knöpfe und andere Bedienelemente, die dem Anschein nach isoliert sind.

Erdung und Verwendung geeigneter elektrischer Armaturen!

In diesem Instrument liegen gefährliche Spannungen an. Alle verwendeten elektrischen Armaturen und Kabel müssen dem angegebenen Typ entsprechen und sich in einwand-freiem Zustand befinden. Alle elektrischen Armaturen sind vorschriftsmäßig anzubringen und zu erden.

Richtiges Netzkabel verwenden!

Das verwendete Netzkabel muß sich in einwandfreiem Zustand befinden und den in der Betriebsanleitung enthaltenen Anschlußwerten entsprechen.

Das Netzkabel muß abnehmbar sein. Der Querschnitt der einzelnen Leiter darf nicht weniger als $0,75 \text{ mm}^2$ betragen. Das Netzkabel sollte einen Prüfvermerk einer zuständigen Prüfstelle tragen, z.B. VDE, Semko oder SEV.

Richtige Stromquelle verwenden!

Dieses Produkt ist für eine Stromquelle vorgesehen, bei der die zwischen den Leitern bzw. zwischen jedem der Leiter und dem Masseleiter anliegende Spannung den in dieser Betriebsanleitung angegebenen Wert nicht überschreitet.

Richtige Sicherung benutzen!

Es ist eine Sicherung zu verwenden, deren Typ, Nennspannung und Nennstromstärke den Angaben für dieses Produkt entsprechen.

Gerät nicht in explosiver Atmosphäre benutzen!

Um der Gefahr einer Explosion vorzubeugen, darf dieses Gerät nicht in der Nähe explosiver Stoffe eingesetzt werden, sofern es nicht ausdrücklich für diesen Zweck zertifiziert worden ist.

Hochspannungsgefahr!

Bei eingeschaltetem Steuerteil liegt im Kabel und im Sensor Hochspannung an.

Informations relatives à la sécurité

Symboles utilisés dans ce manuel d'utilisation

Définition des indications AVERTISSEMENT, ATTENTION et REMARQUE utilisées dans ce manuel.

Avertissement



L'indication AVERTISSEMENT signale un danger potentiel. Elle est destinée à attirer l'attention sur une procédure, une utilisation, une situation ou toute autre chose présentant un risque de blessure en cas d'exécution incorrecte ou de non-respect des consignes.

Attention



L'indication ATTENTION signale un danger potentiel. Elle est destinée à attirer l'attention sur une procédure, une utilisation, une situation ou toute autre chose présentant un risque d'endommagement ou de dégât d'une partie ou de la totalité de l'appareil en cas d'exécution incorrecte ou de non-respect des consignes.

Remarque



L'indication REMARQUE signale des informations importantes. Elle est destinée à attirer l'attention sur une procédure, une utilisation, une situation ou toute autre chose présentant un intérêt particulier.

Symboles apparaissant sur l'appareil

Le tableau suivant décrit les symboles apparaissant sur l'appareil.















Définition des symboles apparaissant sur l'appareil			
			
Marche (sous tension) IEC 417, No. 5007	Arrêt (hors tension) IEC 417, No. 5008	Terre (masse) IEC 417, No. 5017	Terre de protection (masse) IEC 417, No. 5019
			
Masse IEC 417, No. 5020	Equipotentialité IEC 417, No. 5021	Courant continu IEC 417, No. 5031	Courant alternatif IEC 417, No. 5032
			
Courant continu et alternatif IEC 417, No. 5033-a	Matériel de classe II IEC 417, No. 5172-a	Courant alternatif triphase IEC 617-2 No. 020206	
			
Attention : se reporter à la documentation ISO 3864, No. B.3.1	Attention : risque de secousse électrique ISO 3864, No. B.3.6	Attention : surface brûlante IEC 417, No. 5041	

Tableau 3 : Définition des symboles apparaissant sur l'appareil

Mesures de sécurité et mises en garde

Prendre toutes les précautions générales suivantes pendant toutes les phases d'utilisation de cet appareil. Le non-respect de ces précautions ou des avertissements contenus dans ce manuel entraîne une violation des normes de sécurité relatives à l'utilisation de l'appareil et le risque de réduire le niveau de protection fourni par l'appareil. MKS Instruments, Inc. ne prend aucune responsabilité pour les conséquences de tout non-respect des consignes de la part de ses clients.

NE PAS SUBSTITUER DES PIÈCES OU MODIFIER L'APPAREIL

Ne pas utiliser de pièces détachées autres que celles vendues par MKS Instruments, Inc. ou modifier l'appareil sans l'autorisation préalable de MKS Instruments, Inc. Renvoyer l'appareil à un centre d'étalonnage et de dépannage MKS pour tout dépannage ou réparation afin de s'assurer que tous les dispositifs de sécurité sont maintenus.

DÉPANNAGE EFFECTUÉ UNIQUEMENT PAR UN PERSONNEL QUALIFIÉ

L'opérateur de l'appareil ne doit pas enlever le capot de l'appareil. Le remplacement des composants et les réglages internes doivent être effectués uniquement par un personnel d'entretien qualifié.

MISE À LA TERRE DE L'APPAREIL

Cet appareil est mis à la terre à l'aide du fil de terre du cordon d'alimentation. Pour éviter tout risque de secousse électrique, brancher le cordon d'alimentation sur une prise de courant correctement câblée avant de le brancher sur les bornes d'entrée ou de sortie de l'appareil. Une mise à la terre de protection à l'aide du fil de terre du cordon d'alimentation est indispensable pour une utilisation sans danger de l'appareil.

DANGER LIÉ À UN DÉFAUT DE TERRE

En cas de défaut de terre, toutes les pièces conductrices accessibles (y compris les boutons de commande ou de réglage qui semblent être isolés) peuvent être source d'une secousse électrique.

MISE À LA TERRE ET UTILISATION CORRECTE D'ACCESSOIRES ÉLECTRIQUES

Des tensions dangereuses existent à l'intérieur de l'appareil. Tous les accessoires et les câbles électriques doivent être conformes au type spécifié et être en bon état. Tous les accessoires électriques doivent être correctement connectés et mis à la terre.

UTILISATION D'UN CORDON D'ALIMENTATION APPROPRIÉ

Utiliser uniquement un cordon d'alimentation en bon état et conforme aux exigences de puissance d'entrée spécifiées dans le manuel.

Utiliser uniquement un cordon d'alimentation amovible avec des conducteurs dont la section est égale ou supérieure à 0,75 mm². Le cordon d'alimentation doit être approuvé par un organisme compétent tel que VDE, Semko ou SEV.

UTILISATION D'UNE ALIMENTATION APPROPRIÉE

Cet appareil est conçu pour fonctionner en s'alimentant sur une source de courant électrique n'appliquant pas une tension entre les conducteurs d'alimentation, ou entre les conducteurs d'alimentation et le conducteur de terre, supérieure à celle spécifiée dans le manuel.

UTILISATION D'UN FUSIBLE APPROPRIÉ

Utiliser uniquement un fusible conforme au type, à la tension nominale et au courant nominal spécifiés pour l'appareil.

NE PAS UTILISER DANS UNE ATMOSPHÈRE EXPLOSIVE

Pour éviter tout risque d'explosion, ne pas utiliser l'appareil dans une atmosphère explosive à moins qu'il n'ait été approuvé pour une telle utilisation.



DANGER DE HAUTE TENSION

Une haute tension est présente dans le câble et dans le capteur lorsque le contrôleur est sous tension.

Información sobre seguridad

Símbolos usados en el manual de instrucciones

Definiciones de los mensajes de ADVERTENCIA, PRECAUCIÓN Y OBSERVACIÓN usados en el manual.

Advertencia		El símbolo de ADVERTENCIA indica un riesgo. Pone de relieve un procedimiento, práctica, condición, etc., que, de no realizarse u observarse correctamente, podría causar lesiones a los empleados.
Precaución		El símbolo de PRECAUCIÓN indica un riesgo. Pone de relieve un procedimiento, práctica, etc., de tipo operativo que, de no realizarse u observarse correctamente, podría causar desperfectos al instrumento, o llegar incluso a causar su destrucción total o parcial.
Observación		El símbolo de OBSERVACIÓN indica información de importancia. Pone de relieve un procedimiento, práctica, condición, etc., cuyo conocimiento resulta esencial.

Símbolos que aparecen en la unidad

En la tabla que figura a continuación se indican los símbolos que aparecen en la unidad.















Definición de los símbolos que aparecen en la unidad			
			
Encendido (alimentación eléctrica) IEC 417, N.º 5007	Apagado (alimentación eléctrica) IEC 417, N.º 5008	Puesta a tierra IEC 417, N.º 5017	Protección a tierra IEC 417, N.º 5019
			
Caja o chasis IEC 417, N.º 5020	Equipotencialidad IEC 417, N.º 5021	Corriente continua IEC 417, N.º 5031	Corriente alterna IEC 417, N.º 5032
			
Corriente continua y alterna IEC 417, N.º 5033-a	Equipo de clase II IEC 417, N.º 5172-a	Corriente alterna trifásica IEC 617-2 N.º 020206	
			
Precaución. Consultar los documentos adjuntos ISO 3864, N.º B.3.1	Precaución. Riesgo de descarga eléctrica ISO 3864, N.º B.3.6	Precaución. Superficie caliente IEC 417, N.º 5041	

Tabla 4 : Definición de los símbolos que aparecen en la unidad

Procedimientos y precauciones de seguridad

Las precauciones generales de seguridad que figuran a continuación deben observarse durante todas las fases de funcionamiento del presente instrumento. La no observancia de dichas precauciones, o de las advertencias específicas a las que se hace referencia en el manual, contraviene las normas de seguridad referentes al uso previsto del instrumento y podría impedir la protección que proporciona el instrumento. MKS Instruments, Inc., no asume responsabilidad alguna en caso de que el cliente haga caso omiso de estos requerimientos.

NO UTILIZAR PIEZAS NO ORIGINALES NI MODIFICAR EL INSTRUMENTO

No se debe instalar piezas que no sean originales ni modificar el instrumento sin autorización. Para garantizar que las prestaciones de seguridad se observen en todo momento, enviar el instrumento al Centro de servicio y calibración de MKS cuando sea necesaria su reparación y servicio de mantenimiento.

REPARACIONES EFECTUADAS ÚNICAMENTE POR TÉCNICOS ESPECIALIZADOS

Los operarios no deben retirar las cubiertas del instrumento. El cambio de piezas y los reajustes internos deben efectuarlos únicamente técnicos especializados.

PUESTA A TIERRA DEL INSTRUMENTO

Este instrumento está puesto a tierra por medio del conductor de tierra del cable eléctrico. Para evitar descargas eléctricas, enchufar el cable eléctrico en una toma debidamente instalada, antes de conectarlo a las terminales de entrada o salida del instrumento. Para garantizar el uso sin riesgos del instrumento resulta esencial que se encuentre puesto a tierra por medio del conductor de tierra del cable eléctrico.

PELIGRO POR PÉRDIDA DE LA PUESTA A TIERRA

Si se pierde la conexión protectora de puesta a tierra, todas las piezas conductoras a las que se tiene acceso (incluidos los botones y mandos que pudieran parecer estar aislados) podrían producir descargas eléctricas.

PUESTA A TIERRA Y USO DE ACCESORIOS ELÉCTRICOS ADECUADOS

Este instrumento funciona con voltajes peligrosos. Todos los accesorios y cables eléctricos deben ser del tipo especificado y mantenerse en buenas condiciones. Todos los accesorios eléctricos deben estar conectados y puestos a tierra del modo adecuado.

USAR EL CABLE ELÉCTRICO ADECUADO

Usar únicamente un cable eléctrico que se encuentre en buenas condiciones y que cumpla los requisitos de alimentación de entrada indicados en el manual.

Usar únicamente un cable desmontable instalado con conductores que tengan un área de sección transversal equivalente o superior a 0,75mm². El cable eléctrico debe estar aprobado por una entidad autorizada como, por ejemplo, VDE, Semko o SEV.

USAR LA FUENTE DE ALIMENTACIÓN ELÉCTRICA ADECUADA

Este instrumento debe funcionar a partir de una fuente de alimentación eléctrica que no aplique más voltaje entre los conductores de suministro, o entre uno de los conductores de suministro y la puesta a tierra, que el que se especifica en el manual.

USAR EL FUSIBLE ADECUADO

Usar únicamente un fusible del tipo, clase de voltaje y de corriente adecuados, según lo que se especifica para el instrumento.

EVITAR SU USO EN ENTORNOS EXPLOSIVOS

Para evitar el riesgo de explosión, no usar este instrumento o en un entorno explosivo, a no ser que haya sido certificado para tal uso.

PELIGRO POR ALTO VOLTAJE

Cuando el controlador está encendido, se registra alto voltaje en el cable y en el sensor.

Chapter One: General Information

Introduction

The Type 651C instrument is a self-tuning pressure controller for throttle valves. It can supply ± 15 Volts to power and provide a readout for an attached capacitance manometer. The self-tuning feature of the Type 651 unit determines system characteristics necessary for control. This feature takes into account time constants, transfer functions of the valve and plumbing, valve gain, pump speed, and many other important parameters when determining the system characteristics. The 651 unit also includes an adjustable softstart function (to minimize turbulence in the chamber and contamination of the process), Local/Remote transducer zeroing capability, and two process limit relays to indicate if the pressure deviates from the desired trip points.

Located on the front panel is a Key Lock switch used to select front panel or rear panel control. The switch can lock the front panel controls as a safety measure to prevent accidental command entries. The default window display on the front panel shows the pressure readout and the valve position (% open). The pressure readout can be displayed in units of Torr, mTorr, mbar, μbar , Pascal, kPa, cmH_2O , or inH_2O . Five reprogrammable set points are provided, each one having the option of being setup for pressure or position control. Valve open, close, and stop functions are also provided on the front panel for use in system setup and diagnostics.

The 651 instrument has a high-powered driver to operate most MKS type throttle valves, including valves up to 100 mm (4") with vacuum shut-off capability, giving the unit a control range from 10^{-4} to 760 Torr with the appropriate pressure transducers *Appendix C: Product Compatibility*, page 117, lists all MKS products that are compatible with the 651 controller. All MKS unheated and 45° C temperature-controlled, linear Baratron® transducers are compatible with the 651 controller, which is equipped with a low-capacity power supply. The 651 unit can be optionally equipped with a high-capacity power supply, enabling compatibility with 100° C temperature-controlled, linear Baratron transducers. The 651 unit contains a battery-backed memory module which stores configuration and *learned* system information while power is off. There is also an optional valve failsafe battery backup available. The optional battery backup allows user-configuration of the 651 instrument to drive a valve open or closed upon an AC power failure.

How This Manual is Organized

This manual is designed to provide instructions on how to set up, install and operate a Type 651 unit.

Before installing your Type 651 unit in a system and/or operating it, carefully read and familiarize yourself with all precautionary notes in the *Safety Messages and Procedures* section at the front of this manual. In addition, observe and obey all WARNING and CAUTION notes provided throughout the manual.

Chapter One, *General Information*, (this chapter) introduces the product.

Chapter Two, *Installation*, explains environmental requirements and practical considerations to take into account when selecting the proper setting for the pressure control instrument.

Chapter Three, *Overview*, reviews the 651 pressure controller. It describes the components on both the front and rear panels and describes the electrical connections.

Chapter Four, *System Setup*, explains how to connect a valve and set up the 651 pressure controller using the menu selection prompts displayed on the front panel.

Chapter Five, *Local Operation*, describes how to operate the instrument from the front panel and includes detailed instructions for using each of the functions available in Local mode.

Chapter Six, *Remote Operation*, describes RS-232 control and the digital logic operation.

Chapter Seven, *Battery-Backed Memory Module*, provides instructions on how to replace the battery-backed memory module.

Chapter Eight, *Valve Failsafe Battery Backup Option*, provides information on the optional valve failsafe battery backup.

Chapter Nine, *Maintenance*, provides general maintenance procedures.

Appendix A, *Product Specifications*, lists product specifications for the 651 instrument.

Appendix B, *Model Code Explanation*, describes the instrument's ordering code.

Appendix C, *Products Compatibility* supplies information about MKS compatible products.

Appendix D, *Displayless Version*, describes the displayless version and how it differs from the standard 651 unit.

Appendix E, *Initial Settings*, lists the initial settings for the controller.

Appendix F, *Command and Request Reference*, is a summary of the RS-232 commands and responses.

Customer Support

Standard maintenance and repair services are available at all of our regional MKS Calibration and Service Centers, listed on the back cover. In addition, MKS accepts the instruments of other manufacturers for recalibration using the Primary and Transfer Standard calibration equipment located at all of our regional service centers. Should any difficulties arise in the use of your Type 651 instrument, or to obtain information about companion products MKS offers, contact any authorized MKS Calibration and Service Center. If it is necessary to return the instrument to MKS, please obtain an ERA Number (Equipment Return Authorization Number) from the MKS Calibration and Service Center before shipping. The ERA Number expedites handling and ensures proper servicing of your instrument.

Please refer to the inside of the back cover of this manual for a list of MKS Calibration and Service Centers.

Warning

All returns to MKS Instruments must be free of harmful, corrosive, radioactive, or toxic materials.

This page intentionally left blank.

Chapter Two: Installation

How To Unpack the Type 651 Unit

MKS has carefully packed the Type 651 unit so that it will reach you in perfect operating order. Upon receiving the unit, however, you should check for defects, cracks, broken connectors, etc., to be certain that damage has not occurred during shipment.

Note

Do *not* discard any packing materials until you have completed your inspection and are sure the unit arrived safely.

If you find any damage, notify your carrier and MKS immediately. If it is necessary to return the instrument to MKS, obtain an ERA Number (Equipment Return Authorization Number) from the MKS Service center before shipping. Please refer to the inside of the back cover of this manual for a list of MKS Calibration and Service Centers.

Caution

Only qualified individuals should perform the installation and any user adjustments. They must comply with all the necessary ESD and handling precautions while installing and adjusting the instrument. Proper handling is essential when working with all highly sensitive precision electronic instruments.

Unpacking Checklist

Standard Equipment:

- Type 651 Pressure Controller
- Type 651 Instruction Manual (this book)
- Key for the front panel Key Lock switch
- Power Cable

Optional Equipment:

- 651-K1 accessory kit (includes an I/O connector for the rear panel of the unit, a connector cover for the I/O connector, and a screwlock assembly for the I/O connector cover)
- Cables for supported sensors and the MKS Types 253 or 653 valves
- RM-13 or RM-14 rack mount option
- Valve failsafe battery backup (installed in the unit at the factory)
- MKS RS-232 Serial Communications Cable (CB651-10-10)

Note

1. An overall metal braided shielded cable, properly grounded at both ends, is required to meet CE specifications.
2. To order a metal braided shielded cable, add an “S” after the cable type designation. For example, to order a standard cable to connect the 651 controller to a Type 627 transducer, use part number CB259-5-10; for a metal braided, shielded cable use part number CB259S-5-10.

Product Location and Requirements

The Type 651 unit meets the following criteria:

- POLLUTION DEGREE 2 in accordance with IEC 664
- Transient overvoltages according to INSTALLATION CATEGORY II

Operating Environmental Requirements

- Ambient Operating Temperature: 15° to 40° C (60° to 104° F)
15° to 35° C (60° to 95° F) with optional valve failsafe battery back-up
- Main supply voltage fluctuations must not exceed $\pm 10\%$ of the nominal voltage
- Ventilation requirements include sufficient air circulation
- Connect the power cord into a grounded outlet

Safety Conditions

The 651 controller poses no safety risk under the following environmental conditions:

- Altitude: up to 2000 m
- Maximum relative humidity: 80% for temperatures up to 31 °C, decreasing linearly to 50% at 40° C

Setup

Environmental Requirements

Follow these requirements when installing and using a 651 pressure controller.

1. Operating ambient temperature must be in the range of 15° to 40° C (15° to 35° C when equipped with the optional valve failsafe battery backup).
2. Humidity must be kept between 0 and 95%, non-condensing.
3. Position the unit with proper clearance, to allow air cooling, so that the unit can operate within the product temperature specifications listed above.
4. The 651 unit can be mounted in a panel cutout or in either a 9-inch deep or 12-inch deep rack. (The optional valve failsafe battery backup requires 12 inches).
 - A. The RM-13 rack mount option supports a 9-inch deep rack.
 - B. The RM-14 rack mount option supports a 12-inch deep rack.
5. Power and fuse requirements for both the low power and high power units are listed in *Checking the Fuses and Line Voltage Selector Switch*, page 24.

Caution

- A. **Check to make sure the voltage setting is correct for your local electrical source.**
 - B. **Check to make sure the fuse type is appropriate for your voltage setting.**
-

6. A solid system ground should be maintained for proper operation and safety to personnel.

For additional Type 651 controller requirements refer to *Appendix A: Product Specifications*, page 113.

Checking the Fuses and Line Voltage Selector Switch

The 651 unit is shipped with the line voltage set for 115 VAC. If you need to operate the unit with a 230 VAC line voltage, follow the instructions in this section. Refer Table 5 for information on the fuse types.

Fuse Information			
Power Supply Option	Nominal Line	Line Voltage Range	Fuse Type
Low power	115 VAC	90-132 VAC @50/60 Hz 75 VA (max)	0.63A (T), 250V, 5 x 20 mm
	230 VAC	180-264 VAC @50/60 Hz 75 VA (max)	0.315A (T), 250V, 5 x 20 mm
High power	115 VAC	90-132 VAC @48/62 Hz 150 VA (max)	1.25A (T), 250V, 5 x 20 mm
	230 VAC	180-264 VAC @48/62 Hz 150 VA (max)	0.63A (T), 250V, 5 x 20 mm

Table 5: Fuse Information

Note



The fuses are IEC rated (where the name plate value is the expected current *carrying* rating) and not UL or CSA rated (where the name plate value is nearly the current *blowing* rating). Use of UL or CSA rated fuses will cause unnecessary blowing at high loads.

Appropriate replacement fuses include:

- Bussmann GDC-T315 mA or equivalent for the 0.315 A fuse
- Bussmann GDC-T630 mA or equivalent for the 0.63 A fuse
- Bussmann GDC-T1.25 A or equivalent for the 1.25 A fuse

How To Change the Line Voltage

1. Check the current line voltage setting.

Refer to Figure 1 for the location of the voltage selector switch on the *low power* unit, or to Figure 2, page 26, for the location of the switch on the *high power* unit. The label above the switch (on either unit) shows the corresponding voltage range and fuse requirements for either voltage setting.

2. Use a small device, for example, a screwdriver, to set the switch to the left position for operation in the 115 V range, or to the right position for operation in the 230 V range.

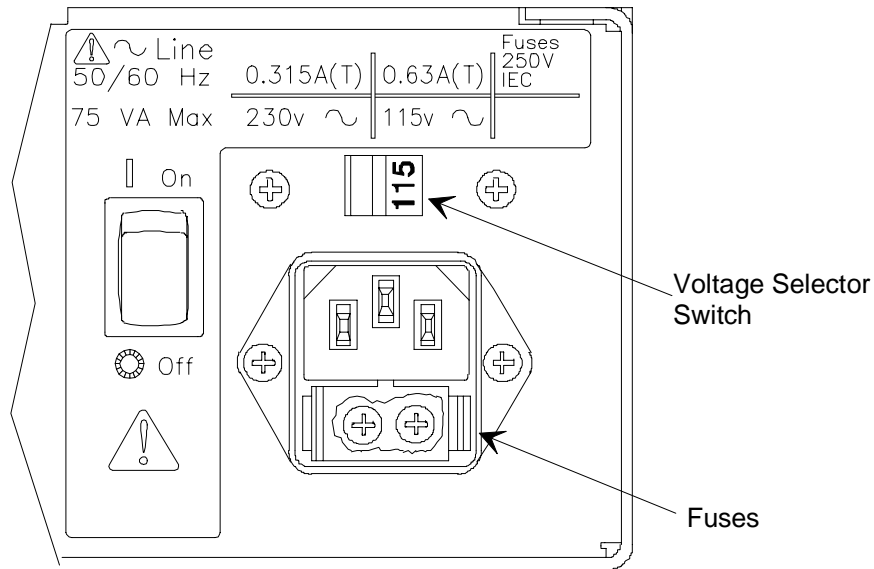

Figure 1: Voltage and Fuse Data for the Low Power Unit

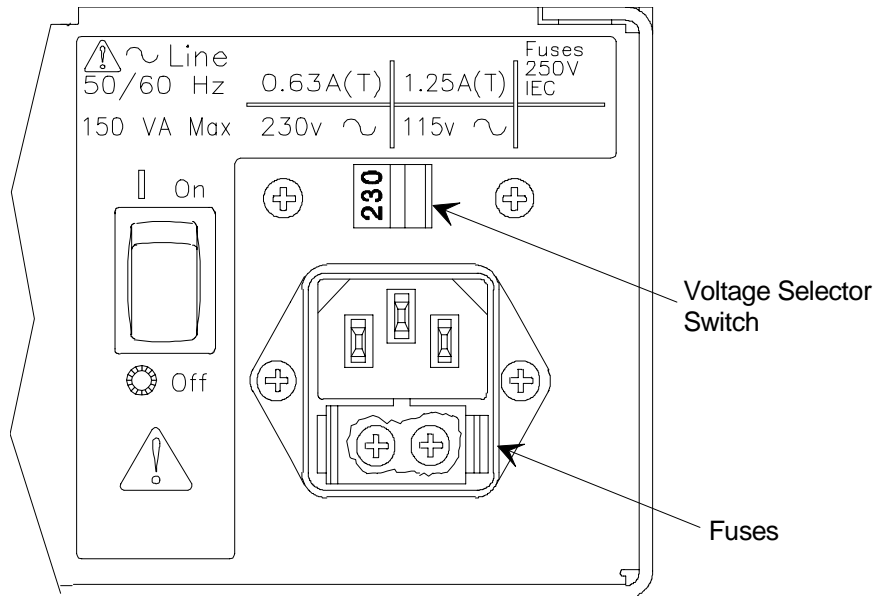

Figure 2: Voltage and Fuse Data for the High Power Unit

The 651 pressure controller is now ready for valve connection and system setup. Refer to *Chapter Three: Overview*, page 27, for an overview of the controller and to *Chapter Four: System Setup*, page 39, for instructions on how to setup and operate the unit.

Chapter Three: Overview

Front Panel

Front Panel Components

Figure 3 labels all the components located on the front panel of the 651 instrument. Table 6, page 28, summarizes the functions of the front panel components.

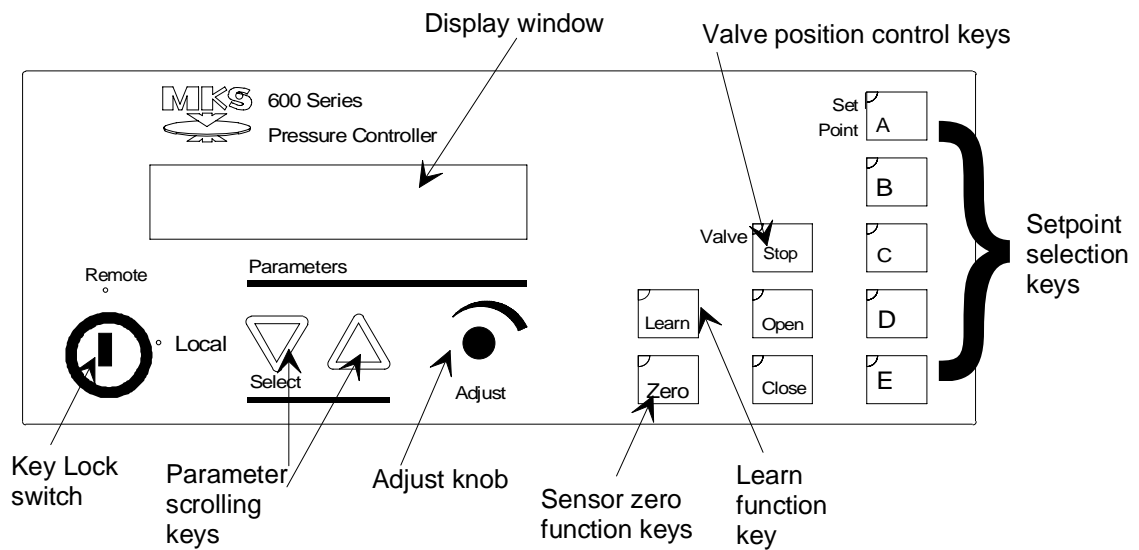

Figure 3: Front Panel of the 651 Instrument

Front Panel Display

The front panel display shows pressure and valve position by default. The down scrolling key, [▽] selects the previous display in the display list. The up scrolling key, [△] scrolls to the next display in the display sequence.

Summary of Front Panel Components	
Front Panel Component	Function
Key Lock switch	Switches between Local (front panel), and Remote (rear panel), control. The switch must be set to Remote to remove the key.
Display window	Displays pressure and the valve position by default. Other displays include information such as set points, trip limits, battery voltage, and softstart rate (depending on how the unit is configured).
Parameter scrolling keys	Used to scroll through displays: [▽] down, and [△] up.
Adjust knob	Used to enter parameter values.
Learn function key	Used to enable the learn function within the 651 unit. In a control system with a positive flow rate, the 651 learn function determines the system characteristics necessary for self-tuning control.
Sensor zero function key	Used to zero an attached sensor.
Valve position control keys	Used to select the valve position. The possibilities are open, close, and stop.
Set point selection keys	Used to select which set point (A through E), is the active set point.
Lights	The lights on the front panel are not visible unless lit. They indicate which parameter(s) (ex. set point A), or function(s) (ex. learn) is currently active.

Table 6: Summary of Front Panel Components

Local and Remote Operation

The Key Lock switch is used to select front panel control (Local) or rear panel control (Remote). When set to Local, control command input and set point parameter modification must be entered via the front panel. Information *requests* (not commands) and 651 unit *responses*, however, may still be sent through the Serial Interface connector on the rear panel. Refer to Table 26, page 128, and Table 27, page 134, for a listing of the request and return message protocol.

When the Key Lock switch is set to Remote, the front panel becomes locked out. This is a useful feature for preventing accidental command entries. It is still possible, however, to scroll through the displays to view existing parameters using the [▽] and [△] keys. When in Remote mode, control command input and set point parameter modification must be entered via the rear panel either by RS-232 command protocol at the Serial Interface connector or through digital logic levels at the I/O connector. Refer to Figure 4, page 31, for the location of the connectors, to Table 8, page 32, for the Serial RS-232 Interface connector pinout, and to Table 10, page 34, for the I/O connector pinout. *Chapter Six: Remote Operation*, page 61, contains more detailed information about RS-232 control and digital logic operation.

Command Priority

The 651 pressure controller responds to the most recent command, whether it is issued in Local mode or Remote mode. In switching from Remote to Local, the 651 instrument will respond to the last command issued in Remote until a new command is issued in Local. In switching from Local to Remote, the 651 instrument will continue to respond to the last command issued in Local until a new command is issued in Remote.

Control Mode: Self-Tuning or PID Control

The 651 instrument can control a vacuum system in one of two ways. When used in the *Self-Tuning* control mode, the 651 instrument determines control parameters based upon the system's characteristics using a unique control algorithm, and does not require the input of lead or gain values. To activate this feature from the front panel, be sure the Key Lock switch is set to Local, and hold down both scrolling keys simultaneously for approximately three seconds, to enter the Setup menu. Scroll through the Setup menu until the Control mode entry appears. The Control mode screen is shown on page 41. To change from PID to Self-Tuning, turn the Adjust knob counterclockwise. Then press the [Learn] key for about three seconds. Once the unit has *learned* the system characteristics, it can operate with the Key Lock switch set to either Local or Remote. Refer to *How To Activate the Learn Function*, page 70, for more information about the [Learn] key.

When used in the *PID* control mode, the 651 unit employs a **P**roportional, **I**ntegral, and **D**erivative (PID) algorithm for control. PID control requires the input of user-defined lead and gain values. Each set point uses its own lead and gain values to optimize response from set point to set point. Although there are default values for lead and gain, you should enter the values for optimum control. To enter lead and gain parameters from the front panel, the Key Lock switch must be set to Local. Select PID Pressure control from the Setup menu to set the lead and gain values. (To enter the Setup menu, hold down both scrolling keys simultaneously for approximately three seconds. Scroll through the Setup menu until the Control mode entry appears. To change from Self-Tuning to PID, turn the Adjust knob clockwise.) Once the lead and gain parameters have been entered, the 651 unit can operate with the Key Lock switch set to either Local or Remote. Refer to *How To Set the Lead and Gain Parameters*, page 81, for instructions on setting lead and gain parameters.

The control mode selection applies to the five internal set points (A through E) and the analog set point.

Softstart Control

The softstart feature is used to reduce the rate at which a control valve moves toward set point. The rate is given as a percent of full speed and can be used on either a pressure or position set point. Once set point is achieved under softstart control, the valve is free to move at full speed. Softstart control can be applied to set points A through E, analog set point, valve open, and valve close. Refer to *Chapter Four: System Setup*, page 39, for instructions on how to set softstart rates from the front panel.

If a set point is established via RS-232 input, the softstart rate for that set point is selected through use of the **I6** value RS-232 command. If an analog set point is established via digital logic input, the softstart rate for the analog set point is controlled by digital logic on pin 7 of the I/O connector. To achieve softstart control of digital logic or analog set points, the *softstart line must be held low*. If the line is *not* held low, the valve will move at 100% full speed. Refer to *Chapter Six: Remote Operation*, page 61, for additional information about softstart control via the rear panel.

Battery Backups

There are two types of batteries used in the 651 instrument: a lithium battery and an optional lead-acid battery. The lithium battery is included inside each 651 unit and is used to power memory for storage of configuration and learned system information while power is off. The optional lead-acid battery allows user-configuration of the 651 instrument to drive a valve open or closed upon an AC power failure.

Rear Panel

Rear Panel Components

Figure 4 labels all the components located on the rear panel of the 651 instrument. The power On/Off switch and the line voltage selector switch are on the back of the 651 unit. The four Type “D” connectors are also located on the rear panel.

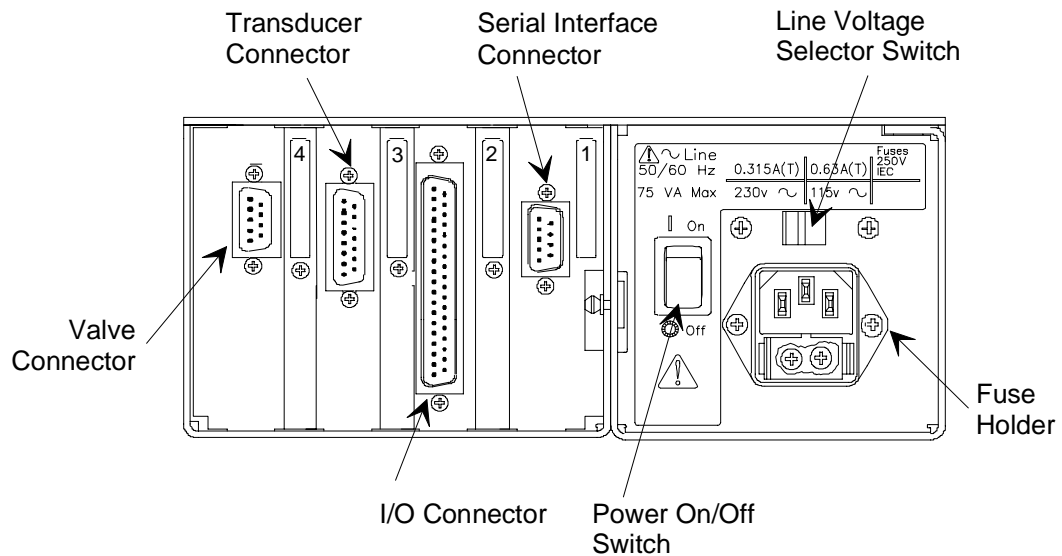

Figure 4: Rear Panel of the 651 Instrument

The connectors are numbered on the rear panel, as listed in Table 7.

Slot Labels	
Slot	Label
Serial Interface connector	1
I/O connector	2
Transducer connector	3
Valve connector	4

Table 7: Slot Labels

Electrical Connections

Tables 8 through 14, on the following pages, list each connector's pinout as well as corresponding MKS cable numbers.

Note



1. An overall metal braided shielded cable, properly grounded at both ends, is required to meet CE specifications.
2. To order a metal braided shielded cable, add an "S" after the cable type designation. For example, to order a standard cable to connect the 651 controller to a Type 627 transducer, use part number CB259-5-10; for a metal braided, shielded cable use part number CB259S-5-10.

Serial RS-232 Interface Connector Pinout	
Pin Number	Function
1	No connection
2	Transmit data
3	Receive data
4	No connection
5	Digital ground
6	Reserved
7	Reserved
8	No connection
9	No connection
<p>A <i>Reserved</i> pin assignment means that the pin has an internal connection and may be assigned a function in the future. The <i>No Connection</i> pin assignment refers to a pin with no internal connection.</p>	

Table 8: Serial RS-232 Interface Connector Pinout

RS-232 Serial Communication Cables	
Serial Interface Cable	Cable Number
651 Serial Communications to 9-pin serial port (pins 2 and 3 straight through)	CB651-10-10
651 Serial Communications to 25-pin serial port (pins 2 and 3 reversed)	CB651-11-10

Table 9: RS-232 Serial Communication Cables

Caution

The MKS RS-232 Serial Communications cable (CB651-10-10) *must* be used for the 9-pin, Serial Interface connector. Unlisted pins on this connector are not compatible with the current Type “D” 9-pin, industry-standard cable.

I/O Connector Pinout	
Pin Number	Function
1	PLO relay #1 - NC contact
2	PLO relay #1 - NO contact
3	PLO relay #2 - NC contact
4	Digital ground
5	Learn system (low)
6	Hold <i>both</i> pin 6 and pin 11 low to select analog set point with position control
7	Softstart (low)
8	Close valve (low)
9	Reserved
10	Analog set point $\div 10$
11	Hold <i>only</i> pin 11 low to select analog set point with pressure control Hold <i>both</i> pin 6 and pin 11 low to select analog set point with position control
12	Select set point E (low)
13	Select set point D (low)
14	Select set point C (low)
15	Select set point B (low)
16	Select set point A (low)
17	Reserved
18	Reserved
19	Valve open status (hi = open)
20	PLO relay 1 - common contact
21	PLO relay 2 - common contact
22	PLO relay 2 - NO contact
23	Valve closed status (hi = closed)
24	Reserved

Table 10: I/O Connector Pinout
(Continued on next page)

I/O Connector Pinout (<i>Continued</i>)	
Pin Number	Function
25	Remote zero (low)
26	Stop valve (low)
27	Open valve (low)
28	PLO #2 status (low = out of limit)
29	PLO #1 status (low = out of limit)
30	+15V Output
31	-15V Output
32	Power ground
33	+ Set point input
34	- Set point input
35	Analog ground
36	Pressure output voltage
37	Position output voltage
<p>A <i>Reserved</i> pin assignment means that the pin has an internal connection and may be assigned a function in the future. The <i>No Connection</i> pin assignment refers to a pin with no internal connection.</p>	

Table 10: I/O Connector Pinout

Transducer Connector Pinout	
Pin Number	Function
1	+15V Supply
2	+ Pressure input
3	Reserved
4	Reserved
5	Power ground
6	-15 V Supply
7	+15 V Supply
8	Reserved
9	-15 V Supply
10	Reserved
11	Digital ground
12	- Pressure input
13	Reserved
14	Reserved
15	Chassis ground

Table 11: Transducer Connector Pinout

System Interface Cables for MKS Transducers	
Transducer Type Number	Cable Numbers
122/124/223/225/622/623	CB112-2-10
127/128/624/625/626/627/628	CB259-5-10
120	CB120-1-10
220	CB112-10-10
121/221	CB112-14-10

Table 12: System Interface Cables for MKS Transducers

Valve Connector Pinout	
Pin Number	Function
1	Motor winding A low
2	Motor winding A high
3	Limit switch ground
4	Open limit switch signal
5	Closed limit switch signal
6	Motor winding B high
7	Motor winding B low
8	+15 V @25 mA (for Opto switches)

Table 13: Valve Connector Pinout

System Interface Cables for MKS Throttle Valves	
Valve Type Number	Cable Number
253A	CB652-2-10
653A	CB652-1-10

Table 14: System Interface Cables for MKS Throttle Valves

Labels

Serial Number Label

The Serial Number Label, located on the side of the instrument, lists the serial number and the product model number, and displays the CE mark signifying compliance with the European CE regulations.



Figure 5: Serial Number Label

The product model number (code) is identified as “651CXYZCD”, where:

- 651C = Type number
- X = Display
- Y = Interface
- Z = Valve Driver
- C = Power Supply
- D = Option

Refer to *Appendix B: Model Code Explanation*, page 115, for more information.

Chapter Four: System Setup

Overview

The 651 pressure controller is configured entirely through menu selection via display lists that appear on the front panel. It is not necessary to open the unit to set any switches. Valve connection and calibration, sensor range and pressure units, etc. are selected by scrolling through the display lists and making adjustments using the controls on the front panel. At initial power up the display screen, listing the current software/firmware version, appears for about five seconds.

The system then defaults to its *pressure and position* display and is ready for valve connection and setup (or normal operation once the system has been configured).

PRES 4.90 Torr
POS 35.0 %

RS-232 Commands and Requests

System setup and control can also be accomplished through RS-232 communications. Refer to Table 26, page 128, for a list of RS-232 commands, and Table 27, page 134, for a list of RS-232 requests and responses.

Valve Selection and Calibration

Prior to its use, the appropriate valve must be connected and identified by the 651 controller. The 651 controller is initially configured to work with a 653 valve. Follow the steps below to select another valve.

Caution



This procedure involves cycling the valve from the open to the close position. Be certain that the system can withstand valve cycling before proceeding. This test can be performed prior to installing the 651 controller and the valve in the system.

1. Be sure that the valve is connected to the 651 unit and the Key Lock switch is set to Local.
2. Press the  and the valve [CLOSE] key simultaneously for about three seconds.

VALVE TYPE:

653

3. Use the Adjust knob to scroll through the display list until the type of valve connected to your unit appears.

The display list includes the following valves:

253 STD

253 FAST

653

4. With the correct valve type displayed, press the [STOP] key to select and calibrate the appropriate valve. The valve will move (open and close) as it is being calibrated, then stop at completion.

Note



Be sure to select the correct valve, otherwise the 651 pressure controller will not function properly.

Setup Menu

The Setup menu enables you to change the configuration of the 651 controller. The initial configuration is listed in *Appendix E: Initial Settings*, page 125. The instructions in this section assume that you will enter the commands from the front panel, so be sure that the key lock switch is set to local.

The Setup menu includes display lists from which selections can be made under the following topics:

- Control mode - PID or Self-Tuning
- Baud rate, parity, and delimiter
- Sensor range and pressure units of measure
- Sensor signal and type
- Analog set point input range and valve signal output
- Set point types A through E, pressure or valve position
- Softstart rates for set points A through E, analog set point, valve open, and valve close
- Direction of valve control

It is possible to exit the Setup menu and return to the system's default display, *pressure and position*, by pressing any key at any time. The Setup menu input can be resumed or restarted by pressing [▽] and [△] simultaneously for about three seconds. Press [▽] or [△] to scroll to the previous or next topic in the Setup menu and use the Adjust knob to select the desired parameters.

Control Mode

The 651 controller is initially configured for PID control. Follow the steps below to change the control mode setting to Self-Tuning control.

1. Press [▽] and [△] simultaneously for about three seconds. The following display appears.

CONTROL	
MODE:	PID

2. Use the Adjust knob to choose either *PID* or *Self-Tuning* control.
3. If you choose Self-Tuning control, press the [LEARN] key for roughly three seconds.

The 651 unit will “learn” the characteristics of your valve. Once the learn process is complete, you can operate the 651 unit in either the Local or Remote mode.

RS-232 Communications

The 651 controller is initially configured with a baud rate of 9600, no parity, 8 data bits, and CRLF delimiter. Follow the steps below to change any of the RS-232 communication parameters.

1. From the *control mode* display, scroll to the next topic in the Setup menu.

BAUD RATE: 9600

2. Select the desired baud rate. The display list includes the following baud rate settings:

300

1200

2400

4800

9600*

* *initial setting*

3. Scroll to the next topic.

PARITY: NONE

4. Choose either *none* (8 data bits, no parity) or *even* (7 data bits, even parity) and scroll to the next topic. The initial setting is 8 data bits, no parity.

DELIMITER: CRLF

5. Choose either CRLF (carriage return/line feed), or CR (carriage return). The initial delimiter is CRLF.

Sensor Setup

The 651 controller is initially configured to use Torr as the pressure units, 100 Torr as the sensor full scale range, 0 to 10 Volts for the sensor input signal, and 0 to 5 Volts for the analog set point input. Follow the steps below to change any of these parameters.

1. Be sure that the sensor is connected to the 651 unit.
2. From the *delimiter* display, scroll to the next topic.

SENSOR RANGE:
10.000

3. Scroll through the display list until the range of the sensor connected to the unit appears.

Note



To view the range of a sensor in pressure units of *mbar* for a sensor calibrated in *Torr*, select the equivalent *mbar* unit of measure. For example, select 13.332 for a sensor calibrated to 10.000 Torr.

To display a 1 Torr sensor in *mTorr*, the appropriate sensor range and pressure unit must be entered during setup. For example, 1000 *mTorr* must be entered to display a 1 Torr sensor in *mTorr*.

The display list includes the following sensor ranges:

.10000	
.20000	
.5000	
1.0000	1.3332
2.0000	2.6664
5.000	
10.000	13.332
50.00	
100.00*	133.32
500.0	
1000.0	1333.2
5000	6666
10000	13332

* *initial value*

4. Scroll to the next topic.

PRESSURE UNITS:
Torr

5. Scroll through the display list until the unit of measure that the sensor has been calibrated to, appears. The display list includes the following pressure units:

Torr*	kPa
mTorr	Pa
mbar	cmH ₂ O
μbar	inH ₂ O

* *initial setting*

6. Scroll to the next topic.

SENSOR SIGNAL:
10 VOLTS

7. Scroll through the display list until the sensor full scale voltage appears. The display list includes the following selections:

1 Volt

5 Volts

10 Volts*

* *initial value*

8. Scroll to the next topic.

SENSOR TYPE:
ABSOLUTE

9. Choose either *absolute* or *differential*.

Analog Set Point

1. From the *sensor type* display, scroll to the next topic in the Setup menu.

ANALOG SETPT RANGE:
10 VOLTS

2. Choose either 5 Volts or 10 Volts full scale signal.

The initial setting is 0 to 5 Volts. Refer to *How To View and Adjust the Analog Set Point*, page 56, or *How To Adjust the Analog Set Point Value*, page 76, for more information.

Valve Position Output

1. From the *analog setpt range* display, scroll to the next topic in the Setup menu.

VALVE SIGNAL OUTPUT:
10 VOLTS

2. Choose either 5 Volts or 10 Volts full scale for valve position output. The 651 controller is initially configured for 0 to 10 Volts.

Set Points A Through E, Pressure/Position Selection

The 651 controller is initially configured to use *pressure* control for all set points, A through E. Follow the steps below to change configuration of any of the set points.

1. From the *valve signal output* display, scroll to the next topic in the menu selection.

SETPOINT A TYPE:
PRESSURE

2. Choose either *pressure* or *position* for set point A and scroll to the next topic.

SETPOINT B TYPE:
POSITION

3. Choose either *pressure* or *position* for set point B.
4. Continue to scroll through the menus in the manner just described, until set points A through E have each been set at either *pressure* or *position*. Refer to *How To View and Adjust Set Points*, page 50.

Note

The function of the analog set point, *pressure* or *position*, is controlled by the digital logic level on Pin 6 of the I/O connector. Refer to *Digital Logic Control*, page 90, for information about establishing the analog set point.

Softstart Rates

Softstart rates for set points A through E, analog set point, valve open, and valve close can be established via the Setup menu. If it is not necessary to utilize softstart control in your process, the softstart rate should be left at 100% (of F.S.).

1. From the set point E *pressure* or *position* display, scroll to the next topic in the menu selection.

SOFT START RATE
SETPT A: 100.0 %

2. Select the softstart rate (between 0.1 and 100%) desired for set point A, then scroll to the next topic.

SOFT START RATE
SETPT B: 100.0 %

3. Select the softstart rate (between 0.1 and 100%) desired for set point B.
4. Continue to scroll through the menus in the manner just described, until set points A through E have each been set at the desired softstart rates.
5. From the *softstart rate* selected for set point E display, scroll to the next topic in the menu selection.

SOFT START RATE
ANLG SETPT: 100%

6. Select the softstart rate (between 0.1 and 100%) desired for analog set point.
7. Continue to scroll through the menus in the manner just described, to set the softstart rates for valve open and valve close.

Valve Control

A valve can be controlled to open and close in a *direct* or *reverse* direction. *Direct* action of valve control is defined as valve open at 100% of the valve position's full scale, and valve close at 0%. *Reverse* action of valve control is defined as valve open at 0% of the valve position's full scale and valve close at 100%. The 651 controller is initially configured to use direct action to control the valve.

1. From the valve close *softstart rate* display, scroll to the next topic in the menu selection.

VALVE DIRECTION:
DIRECT

2. Choose either *direct* or *reverse* direction.



System setup is now complete. Press the [STOP] key to exit the Setup menu and return to the default display, *pressure* and *position*. *Chapter Five: Local Operation*, page 49, discusses *Local Operation* via the front panel and *Chapter Six: Remote Operation*, page 61, provides information about *Remote Operation* of the 651 pressure controller.

Chapter Five: Local Operation

Overview

Local operation of the 651 Pressure Controller is similar to *System Setup* outlined in the previous chapter, in that all functions of the controller can be accessed via display lists, and they respond according to information entered at the front panel. The system software includes display lists from which selections can be made under the following topics:



- How to view and adjust set points, as well as how to activate set points
- How to identify an out-of-range condition
- How to control the valve
- How to activate and stop the learn function
- How to zero a sensor, use special zero, and remove zero
- How to view and adjust process limit relays, as well as how to enable and disable them
- How to view the analog set point, how to zero it, and how to calibrate it to full scale span
- How to view and adjust lead and gain parameters

Be sure the Key Lock switch is set to Local and use  or  to scroll to the appropriate function.

How To View and Adjust Set Points

The 651 instrument provides five user-definable set points (set point A through set point E). Each set point can be configured as a *pressure* set point or a valve *position* set point. Pressure set points are displayed in units of Torr, mTorr, mbar, μ bar, Pascal, or kPa. Position set points are displayed in % open of F.S., where 0 = closed, and 100 = open.

Only one set point can be designated as the active set point. The active set point (or valve position) is indicated by a light in the appropriate set point key.

1. Hold down both arrow keys, [] and [] for approximately three seconds to enter the Setup menu.
2. Scroll until the Control mode screen appears and verify that PID is selected.
3. If Self-Tuning is selected, turn the Adjust knob clockwise to select PID control.
4. Scroll to the set point A screen.

A sample display of set point A (SP A) is shown below. In this example, set point A is defined as 100 mTorr, and the system *pressure* at this time is also 100 mTorr.

SP A	100 mTorr
PRES	100 mTorr

5. Adjust the displayed set point with the Adjust knob on the front panel.

The system responds by immediately storing the set point value. The system pressure does not change however, unless the displayed set point is the active set point.

The display shown below provides another example of a set point display. In this case, set point D (SP D) is configured as a valve *position* set point. The valve position is indicated in % open of F.S., where 0 = closed, and 100 = open. In this example, set point D is configured for a valve position of 60.0% open of F.S., and the system pressure is shown as 2.000 Torr.

SP D	60.0 %
PRES	2.000 Torr

How To Activate Set Points

Activating a set point causes the 651 unit to control to that set point. To activate a set point, press the appropriate set point key (A through E).

The system responds by illuminating a light in the set point key and controlling according to the selected set point. The front panel display changes to reflect the activated set point. That is, the display at the top shows the actual pressure and the display at the bottom shows the valve position.

The light remains lit in the set point key until another set point (or valve function), is chosen.

How To Identify an Out-of-Range Condition

An out-of-range condition occurs at $\pm 105\%$ of F.S. (± 10.5 Volts at sensor input) and is displayed as a positive or negative polarity. An example of a positive out-of-range condition for a set point is shown below.

SP A	3.000 Torr
PRES	+++++++

An example of a negative out-of-range condition displayed on the default screen is shown below.

PRES	----- Torr
POS	0.0 %

How To Control the Valve

The 651 unit can drive the throttle valve to full open or full close, or halt it at its current position.

How To Open the Valve

To drive the valve to full open, press the [OPEN] key. The system responds by turning a light on in the [OPEN] key, and driving the throttle valve to full open. The front panel window returns to the default display of pressure and valve position, if it is not already showing the default display.

The open command overrides the active set point. Pressing any other key on the front panel (except [ZERO] or [LEARN]), cancels the open command.

How To Close the Valve

To drive the valve to full close, press the [CLOSE] key. The system responds by turning a light on in the [CLOSE] key, and driving the throttle valve to full close. The front panel window returns to the default display of pressure and valve position, if it is not already showing the default display.

The close command overrides the active set point. Pressing any other key on the front panel (except [ZERO] or [LEARN]), cancels the close command.

How To Halt the Valve

To stop the valve in its current position, press the [STOP] key. The system responds by illuminating a light in the [STOP] key, and halting the throttle valve in its current position. The front panel window returns to the default display of pressure and valve position, if it is not already showing the default display.

The stop command overrides the active set point. Pressing any other key on the front panel (except [ZERO] or [LEARN]), cancels the stop command.

How To Activate the Learn Function

The learn function, activated by pressing the [LEARN] key, enables the 651 unit to identify important system characteristics for Self-Tuning control. Use the learn function whenever the 651 controller is used in a new vacuum system or when processing conditions are changed (such as changed flow rate, new or refurbished pump, or piping modifications). The learning process may take several minutes to complete.

Note

The system pressure will vary during the learn cycle to as low and high as is possible for the current flow rate.

1. Initiate the proper gas flow into the system.

The Gas flow rate should be close to that used for the actual process (use the maximum flow rate if several flow rates are used in the process).

Do not vary the gas flow rate during learning.

2. Press the [LEARN] key for about three seconds.

The system responds by illuminating a light in the [LEARN] key, and initiating the learning process. The front panel window displays the changing values of pressure and position as the instrument learns the system. The light stays on until the learn function is complete.

How To Stop the Learn Function

It is recommended that the learn function go through to completion. However, if your process is slow to reach its highest pressures *and* your process will not be operating at those pressures, it is possible to stop the learn function early.

Caution

Do not stop the learn function until it is well above the highest pressure at which the process will be operating.

Press the [LEARN] key and the [STOP] key simultaneously for about three seconds. The system responds by stopping the learn function and returning to its prior operation. For example, if the valve was closed before the [LEARN] key was pressed, the valve will now close.

How To Zero a Sensor

Zeroing a sensor is performed to correct sensor zero offsets.

1. Turn the gas flow off.
2. Fully open the control valve.
3. Wait until the system is pumped down to base pressure.

In order to achieve a proper zero, the pressure of the system must be *lower* than the resolution of the Baratron used to measure system pressure. If the pressure reading (at base pressure) is greater than 4% of full range, the sensor will not be zeroed.

4. Press the [ZERO] key for at least three seconds.

The system responds by flashing on a light in the [ZERO] key, and zeroing the sensor. The front panel window shows a pressure reading of zero.

The front panel display changes to reflect a change in system pressure as soon as a change occurs.

How To Use Special Zero

The special zero function is used to zero base pressure in systems where the known pressure is not *at*, but *near* zero (displayed on another readout in the system).

1. Press [>] and the [ZERO] key simultaneously for about three seconds, until the front panel displays *zero base pressure* and the pressure level.
2. Use the Adjust knob to reconcile the pressure reading on the display with the known base pressure reading (displayed on another readout in the system).
3. Press the [STOP] key to exit.

How To Remove Zero

The remove zero function removes the zero correction factor stored in memory, and is used to determine the uncorrected signal from the pressure transducer. Each time a sensor is zeroed, the offset changes. In some applications it may be important to keep the zero offset within a specific range.

Press the [STOP] key and the [Zero] key simultaneously for about three seconds until the front panel display changes from a zero pressure reading to the uncorrected signal level.

How To Set a Process Limit Relay

There are two process limit (PLO) relays in the 651 controller. Each relay has two trip limits: a high trip limit, and a low trip limit. Refer to Table 10, page 34, for the I/O connector pinout to determine which pins are for relay 1, and which are for relay 2. Use the appropriate pins to configure the relays for normally-open or normally-closed operation.

While the pressure remains within PLO limits, the 651 pressure controller actuates the relay (a normally-open contact closes, and a normally-closed contact opens). The 651 pressure controller de-actuates the relay (a normally-open contact opens, and a normally-closed contact closes) when the pressure crosses:

- *above* the *high* trip point
- or
- *below* the *low* trip point

How To View and Adjust a Process Limit Relay

1. Scroll to process limit 1.

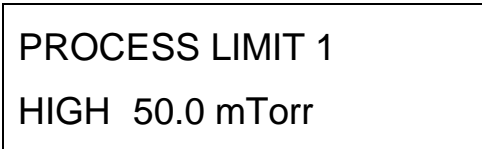

PROCESS LIMIT 1
HIGH 50.0 mTorr

2. Select the desired pressure value for the high trip point of process limit 1.
3. Scroll to the next display.

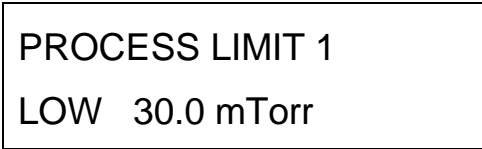

PROCESS LIMIT 1
LOW 30.0 mTorr

4. Select the desired pressure value for the low trip point of process limit 1.
5. Scroll through the menu selections in the manner just described, to set the desired pressure values for process limit 2, high and low trip points.

How To Disable a Process Limit Relay

To disable a high limit trip point, set it to full scale.

To disable a low limit trip point, set it to negative full scale.

How To View and Adjust the Analog Set Point

The 651 controller is capable of accepting one analog set point through the I/O connector on the rear panel. The analog set point can be configured for 5 Volt or 10 Volt full scale input. The *analog set point* display reflects the voltage percent of the actual input. For example, if the 651 unit is configured for 5 Volt full scale input, and the actual input applied is 3 Volts, the analog set point display indicates that input by showing a value of 60%. Similarly, if the 651 unit is configured for 10 Volt full scale input, and the actual input applied is 5 Volts, the analog set point display indicates that input by showing a value of 50%. An example of the analog set point display is shown below.

ANALOG SETPOINT
VALUE: 50.0 %

There is no light on the front panel to indicate that the system is under analog set point control (in fact, all lights on the front panel go out).

How To Zero the Analog Set Point

1. From the default display, *pressure* and *position*, press  and the [STOP] key simultaneously for about three seconds until the following display appears.

CAUTION
CALIBRATION MODE

2. Press the [Set Point B] key. The analog set point display appears.

ANLG SP:-2.99%
LEARN+ZERO to CAL

3. Press the [LEARN] key and the [ZERO] key simultaneously for about three seconds until the analog set point goes to zero.
4. Press any key to return to the default display, *pressure* and *position*.

Note

The maximum adjustment for zero is 15% of full scale.

How To Calibrate Full Scale Span for the Analog Set Point

The 651 units are calibrated at the factory for 10 Volt full scale input; if the actual input applied is 10 Volts, the analog set point display shows a value of 100%. To recalibrate the 651 unit to operate at a full scale input on your system, for example, 9.5 Volts, apply 9.5 Volts to the I/O connector on the rear panel and follow the steps below.

1. From the default display, *pressure* and *position*, press  and the [STOP] key simultaneously for about three seconds until the following display appears.

CAUTION
CALIBRATION MODE

2. Press the [Setpoint D] key. The following display appears.

ANLG SP: 99.90%
FULL SPAN: 20015

3. Use the Adjust knob to change the value of the analog set point to 100%. The 9.5 Volt input to the I/O connector on the rear panel is now the full scale value.

Note



To ensure that the analog set point is adjusted correctly, turn the Adjust knob until the reading flickers between 99.99% and 100.00%. The display reads 100.00% for an overrange reading as well as a true 100% reading.

4. Press any key to return to the default display, *pressure* and *position*.

Note



The maximum adjustment for full scale span is 15% of full scale.

How To Set Lead and Gain Parameters

When the 651 unit is configured for PID control, separate lead and gain parameters are maintained for each pressure set point. Set point A is associated with Lead A and Gain A. Set point B is associated with Lead B and Gain B, and so forth.

When an analog set point is used with PID control, the lead and gain parameters associated with any of the pressure set points (set points A through E) may be used. To specify which set point's lead and gain parameters to use, apply a TTL low level signal to the I/O connector pin assigned to the desired set point. Refer to Table 10, page 34, for a description of the pin assignments for the digital inputs. The TTL low level signal (0 to 0.8 Volts) is "level sensitive" meaning that once the signal is held low, the 651 unit may take up to 50 milliseconds to recognize the command. The line must be held low *continuously* for the 651 unit to use the selected parameters. Once the signal goes high, the instrument will default back to set point A parameters within 50 milliseconds. For example, to apply the lead and gain parameters associated with set point C to the analog set point, apply a 0 to 0.8 Volt signal to pin 14 (on the I/O connector) for as long as you wish to use those parameters.

1. Hold down both arrow keys, [▽] and [△] for approximately three seconds to enter the Setup menu.
2. Scroll to the Control mode screen appears and verify that PID is selected.
3. If Self-Tuning is selected, turn the Adjust knob clockwise to select PID control.
4. Adjust the set point lead and gain parameters.

By careful adjustment of the lead and gain parameters, it is possible to achieve optimum control throughout a wide range of pressure regions. Examples of Lead and Gain for set point A are shown below.

LEAD A	1.25 SEC.
PRES	350 Torr

GAIN A	25.0%
PRES	350 Torr

5. Use the Adjust knob to enter the desired lead and gain parameters.

The 651 unit will use the lead and gain values associated with set point A by default.

If a set point is configured as a valve position, then *no* lead or gain parameters are associated with it.

How To Calibrate Span of the A/D Converter

The controller's A/D (analog-to-digital) converter converts the analog input to a digital value that the controller uses. The span of the A/D converter is calibrated at the factory before you receive your controller. You should perform this calibration if you receive a checksum error when you power up the controller, or if the transducer's readings are incorrect.

To calibrate the span of the A/D converter:

1. Apply a *known* voltage of between +6.6 Volts and +7.4 Volts to the pressure input pins on the transducer connector. Connect a differential voltage to pins 2 and 12 with pin 12 tied to pin 5.

Refer to Table 11, page 36, for the transducer connector pinout. You must know the exact voltage applied, in order to complete step 4.

2. Press [\triangle] and [STOP] key simultaneously for about three seconds. The following display appears.

CAUTION
CALIBRATION MODE

3. Press the following keys, in the following order:

[Set Point C] [Set Point A] and [Set Point E]. The following display appears.

CAL VOLTS:
REF COUNTS:

4. Use the Adjust knob to enter the value from Step 1 as the Cal Volts.
5. Press the [STOP] key to exit the calibration procedure.

The controller takes the Cal Volts value and assigns it to the converter reading of the pressure, as an analog input.

Calibrating the span of the A/D converter may take up to 5 seconds.

This page intentionally left blank.

Chapter Six: Remote Operation

Overview

Remote operation of the 651 Pressure Controller is accomplished via the rear panel either by RS-232 communication by means of a computer connected to the Serial Interface connector or through analog or digital logic levels at the I/O connector. When the Key Lock switch is set to Remote, all control commands and parameter modifications must be sent through the connectors. The front panel becomes locked; however, it is still possible to scroll through and view current set points (pressure and position). This chapter contains information about RS-232 and analog or digital logic control.

Refer to *RS-232 Communications*, page 42, discusses the initial settings for the communication parameters.

RS-232 Commands and Requests

Messages sent to the 651 controller are either *commands* that instruct the controller to change an operating parameter, or *requests* that prompt the controller to report status information.

Responses sent by the 651 controller reply to a request message issued by means of your computer's RS-232 communication software.

All messages must use a carriage return-line feed (CRLF) as the end-of-line delimiter. Use your host computer's communications software to assign the CRLF action to the key.

Message Syntax

The information presented in this section applies to all RS-232 messages. The RS-232 message syntax uses the following typographical conventions:

bold	Commands and requests that you must enter exactly as shown in the manual.
<i>italics</i>	Placeholder that represents text or numeric values that you must supply.
response	Format of messages sent from the 651 controller.
<input type="text" value="ENTER"/>	Represents carriage return-line feed combination that you have configured as the end-of-line delimiter.

Commands Sent from the Computer to the 651 Controller

Table 26, page 128, lists the syntax for RS-232 commands. Commands are not case sensitive. If a command requires user-supplied parameters, it is not necessary to type a space between the command and the parameters. In the table, each command is separated from parameters with an optional space for clarity. For example, the **S1** command to assign set point A a *value* of 20 is shown in Table 26, page 128, as:

S1 *value* and the actual keys pressed would be:

S120

If you choose to use an optional space for clarity, the actual keys pressed would be:

S1 20

Note

When sending *any* message (command or request) to the 651 controller, you must finish the message by pressing the key. This appends a carriage return-line feed to the end of the message. Use your communications software to configure the end-of-line delimiter as a carriage return-line feed.

Requests Sent from the Computer to the 651 Controller

Table 27, page 134, lists RS-232 request and response messages. Requests are not case sensitive. You do not supply additional parameters with requests. For example, the **R1** request to respond with the *value* of set point A is shown as:

R1 and the actual keys pressed would be:

R1

Responses Sent from the 651 Controller to the Computer

Responses sent from the 651 controller to your computer are shown in the last column of Table 27, page 134. The format of responses sent by the 651 controller to the computer will appear in the table as:

`response value`

where `response` is a label that allows you to identify the response and `value` is the information requested.

Note

Controller responses do not contain spaces. Any spaces shown in the response syntax are simply used to improve readability.

The 651 controller appends a carriage return-line feed to the end of every response.

For example, the controller's response to the **R1** request for the value of set point A is shown in the table as:

`S1 value` where `value` is a % of F.S.

To report a set point of 3 Torr on a 10 Torr sensor, the controller sends:

`S130`

Priority of Command Execution

Each RS-232 command is executed in the order that it is received. There is no prioritization of RS-232 commands as is the case with digital logic commands. In fact, the appropriate RS-232 command will override a *high priority* digital logic command. For example, a valve being held closed with a digital logic command can be commanded to control to the level of set point A with the appropriate RS-232 command.

The RS-232 commands generally execute within 25 milliseconds or less with the exception of the following:

- **T** (set point type) and **F** (pressure unit) commands can take up to 100 milliseconds to execute
- **J** (valve calibration) and **L** (learn function) commands can take several seconds to execute

How To Change Valve Selection and Calibration

The 651 controller is initially configured as if it is controlling a Type 653 valve. You must reconfigure the 651 controller to work with a Type 253 valve. Follow the steps below to select another valve.

Caution



This procedure involves cycling the valve from the open to the close position. Be certain that the system can withstand valve cycling *before* proceeding. This test can be performed prior to installing the 651 controller and the valve in the system.

1. Be sure that the valve is connected to the 651 unit.
2. Issue the following command to calibrate the controller and valve:

J value

where *value* = 1 for standard 253 valve
 2 for a fast 253 valve
 3 for a 653 valve

The valve will move (from fully open to fully closed) and then stop at the completion of the calibration procedure.

Note



Be sure to select the correct valve, otherwise the 651 pressure controller will not function properly.

3. Learn the new valve by following the procedures described in *How To Activate the Learn Function*, page 53.

How To Determine and Change the Control Mode

The 651 controller is initially configured for PID control. Follow the steps below to change the control mode setting.

1. To determine which control mode is currently selected, issue the request:

R51

The 651 controller will return the following response:

V value

where *value* is:

0 = Self-Tuning control

1 = PID control

2. To change the control mode, issue one of the following two commands.

For Self-Tuning control:

V0

For PID control:

V1

3. If you choose Self-Tuning control, issue the following command to learn the system:

L

The 651 unit will “learn” the characteristics of your system.

Caution



During the learn process, the 651 controller moves the valve from the opened to the closed position. Be sure your system is set up to allow the valve to move from full open to full closed.

How To Configure the Sensor Parameters

The 651 controller is initially configured to use 100 Torr as the sensor full scale range, and 0 to 10 Volts for the sensor input signal. Follow the steps below to change these parameters.

Note



Be sure that the sensor is connected to the 651 controller before changing the sensor parameters.

How To Change the Sensor Type

The 651 controller can work with either Absolute or Differential pressure sensors. Issue the following command to select the sensor type:

U *value*

where *value* is 0 for Absolute; 1 for Differential.

How To Change the Sensor Full Scale Voltage

The 651 controller is initially configured for a 10 Volt full scale sensor. To change the full scale voltage, issue the command:

G *value* ENTER

where *value* is a valid sensor full scale voltage. Valid full scale voltages are:

<i>value</i>	Full Scale Voltage
0	= 1 Volt
1	= 5 Volts
2	= 10 Volts*

* *initial value*

How To Change the Sensor Range

The 651 controller is initially configured to work with a 100 Torr pressure sensor. If your sensor covers a different range, issue the command:

E value

where *value* is a valid sensor range. Refer to Table 15 for the complete list of valid sensor ranges.

Sensor Range Values					
Torr			millibar		
0	=	0.1	13	=	1.33
1	=	0.2	14	=	2.66
2	=	0.5	15	=	13.33
3	=	1	16	=	133.3
4	=	2	17	=	1333
5	=	5	18	=	6666
6	=	10	19	=	13332
7	=	50			
8	=	100*			
9	=	500			
10	=	1000			
11	=	5000			
12	=	10000			
* <i>initial value</i>					

Table 15: Sensor Range Values

Note



Pressure readings are reported as % of full scale (F.S.), where full scale is the sensor range value shown in the table. For example, if the actual pressure is 10 Torr for a 10 Torr F.S. unit, then the 651 controller reports a pressure reading *value* = 100 (for 100%).

If the pressure is 10 Torr for a 100 Torr F.S. unit, then the 651 controller reports a pressure reading *value* = 10 (for 10%).

How To Request the Pressure Reading

To request the system pressure, issue the request:

R5

The 651 controller responds with the message:

P *value*

where *value* is % of Full Scale.

For example, if the pressure is 10 Torr for a 10 Torr F.S. unit, then *value* = 100.

If the pressure is 10 Torr for a 100 Torr F.S. unit, then *value* = 10.

Converting Pressure Readings to Absolute Pressure Values

To convert pressure readings to absolute pressure values:

1. Request the pressure reading by issuing the request:

R5

The 651 controller responds with the message:

P *value*

where *value* is % of Full Scale.

2. Calculate the absolute pressure using the formula:

Absolute pressure = (P *value*/100) X (Full Scale)

For example, if the pressure reading for a 1000 Torr F.S. unit was reported as 65 (65%), the absolute pressure is:

Absolute pressure = (65/100) X (1000) = 650 Torr

How To Zero a Sensor

Zeroing a sensor allows you to correct any zero offsets.

1. Turn the gas flow off.
2. Fully open the control valve.
3. Wait until the system is pumped down to base pressure.

In order to achieve a proper zero, the pressure of the system must be *lower* than the resolution of the Baratron used to measure system pressure. If the pressure reading (at base pressure) is greater than 4% of full range, the sensor will not be zeroed.

4. Issue the following command to zero the sensor:

Z1

The system responds by zeroing the sensor. The system pressure reading will be zero.

How To Use the Special Zero

The special zero function is used to zero base pressure in systems where the known base pressure is not *at*, but *near* zero (as measured by another transducer on the system).

- To command the special zero function, set your system at base pressure and send the command:

Z2 *value*

The *value* is expressed as % of full scale pressure.

$$value = \frac{\text{known base pressure reading}}{\text{transducer's full scale}}$$

How To Remove the Zero

The remove zero function removes the zero correction factors (**Z1** and **Z2** corrections) stored in memory, and is used to determine the uncorrected signal from the pressure transducer. Each time a sensor is zeroed, the offset changes. In some applications it may be important to keep the zero offset within a specific range.

- To remove the zero correction, send the command:

Z3

How To Activate the Learn Function

The learn function enables the 651 unit to identify important system characteristics for Self-Tuning control. Use the learn function whenever you install a new vacuum system or change any processing conditions (such as changed flow rate, new or refurbished pump, or piping changes). The learning process may take several minutes to complete.

Note

The system pressure will vary during the learn cycle to as low and high as is possible for the current flow rate.

1. Initiate the proper gas flow into the system.

Gas flow rate should be close to that used for the actual process (use the maximum flow rate if several flow rates are used in the process). **Do not** vary the gas flow rate during the learn function.

2. Issue the following command to initiate the learn function:

L

The system responds by initiating the learning process. This process may take several minutes to complete.

3. Issue a system status request message to determine the status of the learn process:

R37

The 651 controller responds with the following message:

XYZ

where $X=0$ for remote control

- Y indicates the system status
 - 0 when not performing the learn process
 - 1 when performing the learn process
 - 2 when learning the valve
- Z
 - 0 for valve open
 - 1 for valve close
 - 2 valve stop
 - 3 set point A
 - 4 set point B
 - 5 set point C
 - 6 set point D
 - 7 set point E
 - 8 analog set point

How To Stop the Learn Function

It is recommended that the learn function go through to completion. However, if your process is slow to reach its highest pressures *and* your process will not be operating at those pressures, it is possible to stop the learn function early.

Caution

Do not stop the learn function until it is well above the highest pressure at which the process will be operating.

- To stop the learn function, issue the command:

Q

The system responds by stopping the learn function and returning to its prior operation. For example, if the valve was closed before the learn function was initiated, the valve will now close.

How To Determine the Active Set Point

To determine the set point currently selected as active:

- Issue the following request to determine the active set point:

R7

The 651 controller responds with the following message:

XYZ

where X = indicates the active set point:

- 0 for the analog set point
- 1 for set point A
- 2 for set point B
- 3 for set point C
- 4 for set point D
- 5 for set point E

Y = indicates the valve status:

- 0 for controlling
- 2 for valve open (direct direction)
- 4 for valve close (direct direction)
- 2 for valve close (reverse direction)
- 4 for valve open (reverse direction)

Z = indicates the pressure:

- 0 when the pressure < 10% F.S.
- 1 when the pressure \geq 10% F.S.

How To Select the Active Set Point

The 651 instrument provides five user-definable set points (set point A through set point E) and one external analog set point, received through the I/O connector. The 651 controller uses the “active” set point to control the system. Only one set point can be designated as the active set point.

- Issue the following command to select the active set point:

Dx

where $x =$

- 1 for set point A
- 2 for set point B
- 3 for set point C
- 4 for set point D
- 5 for set point E
- 6 for the analog set point

How To Select Pressure or Position Control

The 651 controller is initially configured to use *pressure* control for the internal set points, A through E, and the analog set point.

- To select pressure or position control, issue the command:

T*x value*

where *x* = 1 for set point A type
 2 for set point B type
 3 for set point C type
 4 for set point D type
 5 for set point E type
 6 for the analog set point type

value = 0 for position
 1 = pressure

Note



This RS-232 command overrides the digital logic control for the analog set point. Refer to *Digital Logic Control*, page 90, for information about the digital logic control of the analog set point.

- To check the type of control selected for a set point, issue the request:

R*xx*

where *xx* = 25 for the analog set point type
 26 for set point A type
 27 for set point B type
 28 for set point C type
 29 for set point D type
 30 for set point E type

The 651 controller responds with the following message:

T*x value*

where *x* = 0 for the analog set point
 1 for set point A
 2 for set point B
 3 for set point C
 4 for set point D
 5 for set point E

value = 0 for position
 1 = pressure

How To Change the Set Point Value

Follow these instructions to change the value of one of the internal set points, A through E. Refer to *How To Adjust the Analog Set Point Value*, page 76, for information on changing the analog set point value.

1. Issue the following command to set the value of the set point:

Sx value

where x = 1 for set point A
 2 for set point B
 3 for set point C
 4 for set point D
 5 for set point E

$value$ = % of full scale pressure, if the unit is in pressure control
 % of open, if the unit is in position control (direct direction)
 % of close, if the unit is in position control (reverse direction)

The system responds by immediately storing the set point value. The system pressure does not change however, unless the selected set point is the *active* set point.

2. To check the set point value for any set point, issue the request:

Rx

where x = 1 for set point A value
 2 for set point B value
 3 for set point C value
 4 for set point D value
 10 for set point E value

The 651 controller responds with the following message:

Sx value

where x = 1 for set point A value
 2 for set point B value
 3 for set point C value
 4 for set point D value
 5 for set point E value

$value$ = % of full scale pressure, if the unit is in pressure control
 % of open, if the unit is in position control (direct direction)
 % of close, if the unit is in position control (reverse direction)

How To Adjust the Analog Set Point Value

The 651 controller is capable of accepting one *analog set point* through the I/O connector on the rear panel. The analog set point value is expressed as a % of full scale, using the following formula:

$$\text{analog set point} = (\text{analog set point voltage} / \text{full scale voltage})$$

For example, if the 651 unit is configured for 5 Volt full scale input, and the actual input applied is 3 Volts, the analog set point value will be 60%. Similarly, if the 651 unit is configured for 10 Volt full scale input, and the actual input applied is 5 Volts, the analog set point value will be 50%.

The system responds to an analog set point voltage by immediately storing the analog set point value. The system pressure does not change however, unless the analog set point is the active set point. Refer to *How To Determine the Active Set Point*, page 72, for more information.

How To Set the Analog Set Point Full Scale Range

The analog set point can be configured for 5 Volt or 10 Volt full scale input.

1. To change the analog set point full scale range, issue the command:

A *value*

where *value* is 0 for 5 Volt range; 1 for 10 Volt range.

2. To check the analog set point full scale range, issue the request:

R24

The 651 controller will send the following response:

A *value*

where *value* is 0 for 5 Volt range; 1 for 10 Volt range.

How To Zero the Analog Set Point

Zeroing the analog set point allows you to correct any zero offsets.

The **Z4** command instructs the controller to take the current value of the external analog set point for its zero value.

To zero the analog set point:

1. Supply zero input voltage on I/O connector pins 33 and 34.
2. Issue the following command to learn the zero of the analog set point:

Z4

The 651 controller learns the input voltage that corresponds to an analog set point zero value.

How To Learn Analog Set Point Full Scale

The controller is calibrated at the factory for 10 Volt full scale input; if the actual input applied is 10 Volts, the controller's analog set point reading is 100 (100%). To recalibrate the controller to operate at a full scale input of, for example, 9.5 Volts, you can learn the analog set point full scale via the **Y2** command. This command allows you to correct any full scale offsets.

The **Y2** command instructs the controller to take the current value of the external analog set point for its full scale value.

To learn the analog set point full scale:

1. Supply full scale input voltage on I/O connector pins 33 and 34.
2. Send the command:

Y2

If the current value of the analog set point is beyond $\pm 15\%$ of full scale, the controller will not change the current full scale value.

How To Set the Full Scale Level of the Analog Set Point

1. Issue the following command to set the value of the analog set point:

S6 *value*

where *value* = 0 for 100% of the controlling transducer's range;
1 for 10% of the controlling transducer's range.

2. To check the full scale level of the analog set point value, issue the request:

R0

The 651 controller responds with the following message:

S0 *value*

where *value* is % of the controlling transducer's range.

How To Calibrate Span of the A/D Converter

The controller's A/D (analog-to-digital) converter converts the analog input to a digital value that the controller uses. The span of the A/D converter is calibrated at the factory before you receive your controller. You should perform this calibration if you receive a checksum error when you power up the controller, or if the transducer's readings are incorrect.

To calibrate the span of the A/D converter:

1. Apply a voltage of between +6.6 Volts and +7.4 Volts to the pressure input pins on the transducer connector. Connect a differential voltage to pins 2 and 12 with pin 12 tied to pin 5.

Refer to Table 11, page 36, for the transducer connector pinout. You must know the exact voltage applied, in order to complete step 2.

2. Send the command:

Y1 *value*

where *value* is the (applied voltage/F.S.) expressed as a percent. For example, if the applied voltage is 7.0 Volts with 10 Volts = F.S., *value* = +70

For this example, *value* = 70 and the command is:

Y1+70.00

The controller takes the value from the command and assigns it to the converter reading of the pressure as an analog input. In this example, the 7 Volt input = 70.00.

Calibrating the span of the A/D converter may take up to 5 seconds. To check that the calibration is finished, enter the request **R52** (checksum error request); the controller responds "immediately." The controller will respond to the request immediately after it finishes the span calibration.

Note



If the response to the **R52** checksum command is "1", the controller is reporting that the checksum error still exists. In that case, perform the procedure to calibrate the span of the A/D converter again. If the error persists, it indicates a hardware failure of the EEPROM. Contact any MKS Service Center, listed on the inside back cover of this manual, for assistance.

How To Respond To a Checksum Error

A checksum error message indicates the controller has detected a calibration problem. The controller send a checksum error message in the following circumstances:

- at system power up
- in response to the **R52** checksum command (1 = error)

If the controller detects a checksum error, perform a full calibration to correct the problem.

To perform a full calibration:

1. Zero the analog set point.

Perform the steps described in *How To Zero the Analog Set Point*, page 77.

2. Learn the analog set point full scale.

Perform the steps described in *How To Learn Analog Set Point Full Scale*, page 77.

3. Calibrate the span of the A/D converter.

Perform the steps described in *How To Calibrate Span of the A/D Converter*, page 79.

If the checksum error persists after you perform a full calibration, the error indicates a hardware failure of the EEPROM. Contact any MKS Service Center, listed on the inside back cover of this manual, for assistance.

How To Set the Lead and Gain Parameters

When the 651 unit is configured for PID control, separate lead and gain parameters are maintained for each pressure set point. Set point A is associated with Lead A and Gain A. Set point B is associated with Lead B and Gain B, and so forth.

When an analog set point is used with PID control, the lead and gain parameters associated with any of the pressure set points (set points A through E) may be used. To specify which set point's lead and gain parameters to use, apply a TTL low level signal to the I/O connector pin assigned to the desired set point. Refer to Table 10, page 34, for a description of the pin assignments for the digital inputs. The TTL low level signal (0 to 0.8 Volts) is "level sensitive" meaning that once the signal is held low, the 651 unit may take up to 50 milliseconds to recognize the command. The line must be held low *continuously* for the 651 unit to use the selected parameters. Once the signal goes high, the instrument will default back to set point A parameters within 50 milliseconds. The 651 unit will use the lead and gain values associated with set point A by default.

For example, to apply the lead and gain parameters associated with set point C to the analog set point, apply a 0 to 0.8 Volt signal to pin 14 (on the I/O connector) for as long as you wish to use those parameters.

If a set point is configured as a valve position, then *no* lead or gain parameters are associated with it.

1. To determine which control mode is currently selected, issue the request:

R51

The 651 controller will return the following response:

V *value*

where *value* is a 0 for Self-Tuning control; a 1 for PID control.

2. If necessary, issue the following command to select PID control:

V1

3. Issue the following command to enter a new lead parameter:

X*xvalue*

where <i>x</i> =	1 is the lead parameter for set point A
	2 is the lead parameter for set point B
	3 is the lead parameter for set point C
	4 is the lead parameter for set point D
	5 is the lead parameter for set point E
<i>value</i> =	lead value (in seconds)

4. Issue the following command to enter a new gain parameter:

M*x value*

where *x* = 1 is the gain parameter for set point A
 2 is the gain parameter for set point B
 3 is the gain parameter for set point C
 4 is the gain parameter for set point D
 5 is the gain parameter for set point E

value = gain value (in percent)

5. To check the value of a lead or gain entry, issue the request:

R*xx*

where *xx* = 41 requests the lead parameter for set point A
 42 requests the lead parameter for set point B
 43 requests the lead parameter for set point C
 44 requests the lead parameter for set point D
 45 requests the lead parameter for set point E
 46 requests the gain parameter for set point A
 47 requests the gain parameter for set point B
 48 requests the gain parameter for set point C
 49 requests the gain parameter for set point D
 50 requests the gain parameter for set point E

If the request is for a *lead* parameter, the 651 controller sends the response:

Xx value

where *x* = 1 is the lead parameter for set point A
 2 is the lead parameter for set point B
 3 is the lead parameter for set point C
 4 is the lead parameter for set point D
 5 is the lead parameter for set point E

value = lead parameter (in seconds)

If the request is for a *gain* parameter, the 651 controller sends the response:

Mx value

where *x* = 1 is the gain parameter for set point A
 2 is the gain parameter for set point B
 3 is the gain parameter for set point C
 4 is the gain parameter for set point D
 5 is the gain parameter for set point E

value = gain parameter (in percent)

How To Set The Softstart Control Rate

Each set point, A through E, can be assigned a different softstart rate. In addition, you can assign a softstart rate for the valve open and valve close commands. If it is not necessary to utilize softstart control in your process, leave the softstart rate at 100% (of F.S.).

The softstart control rate is always expressed as a percent of the valve's full speed. The softstart rate can range from 0.1 to 100%.

How To Set the Softstart Rate

Issue the RS-232 command:

$Ix \text{ value}$

where $x =$	1 for set point A
	2 for set point B
	3 for set point C
	4 for set point D
	5 for set point E
	6 for the analog set point
	7 for valve open
	8 for valve close
$\text{value} =$	softstart rate, expressed as a percent of full speed (between 0.1 and 100%)

How To Use the Softstart Rate

The use of the softstart rate for the active set point is controlled by digital logic input (pin 7 on the I/O connector). This applies whether the set point is selected through the RS-232 command described above, or through the digital input logic. Refer to Table 10, page 34, for the digital input pinout.

The RS-232 command allows you to select the softstart rate, whereas the state of pin 7 determines whether the softstart rate is used.

To activate softstart control:

- Hold the softstart line low (pin 7 on the I/O connector)

Hold the TTL low signal for a minimum of 50 milliseconds. If the line is *not* held low, the valve will move at 100% full speed.

How To Check the Softstart Rate

Issue the RS-232 request:

Rxx

where *xx* =

- 15 for set point A
- 16 for set point B
- 17 for set point C
- 18 for set point D
- 19 for set point E
- 20 for the analog set point
- 21 for valve open
- 22 for valve close

The 651 controller responds with the message:

Ix value

where *x* =

- 1 for set point A
- 2 for set point B
- 3 for set point C
- 4 for set point D
- 5 for set point E
- 6 for the analog set point
- 7 for valve open
- 8 for valve close

value = softstart rate, expressed as a percent of full speed
(between 0.1 and 100%)

How To Configure the Valve Parameters

In order for the 651 controller to work properly with your valve, you need to check several valve parameters. All of the parameters are set to an initial value, so it may be unnecessary for you to change any entries.

How To Check the Valve Selected

1. To check the type of valve selected, issue the request:

R23

The 651 controller responds with the message:

J type

where *type* = 1 for a standard 253
 2 for a fast 253
 3 for a 653

How To Change and Calibrate the Valve

1. To change and calibrate the valve, issue the command:

J value

where *value* = 1 for a standard 253
 2 for a fast 253
 3 for a 653

Caution



During the calibration process, the 651 controller learns the valve by moving it from the opened to the closed position. Be sure your system is set up to allow the valve to move from full open to full closed.

How To Change the Valve Position Output

The valve position output can be configured for 5 Volts or 10 Volts full scale. The 651 controller is initially configured for 10 Volts. To change the valve position output, follow the steps below.

1. To change the valve position output range, issue the command:

B value

where *value* is 0 for the 5 Volt range; 1 for the 10 Volt range.

2. To check the current valve position output, issue the request:

R31

The 651 controller responds with the message:

B *value*

where *value* is 0 for the 5 Volt range; 1 for the 10 Volt range.

How To Change the Valve Control Direction

A valve can be controlled to open and close in a *direct* or *reverse* direction. *Direct* valve control direction is defined as valve open at 100% of the valve position's full scale and valve close at 0%. *Reverse* valve control direction is defined as valve open at 0% of the valve position's full scale and valve close at 100%.

The 651 controller is initially configured to use direct action to control the valve.

1. To change the direction, issue the command:

N value

where *value* is a 0 for direct direction; 1 for reverse direction.

2. To check the current valve control selection, issue the request:

R32

The 651 controller responds with the message:

N *value*

where *value* is a 0 for direct action; 1 for reverse action.

How To Control the Valve

You can command the 651 unit to drive the throttle valve to full open or full close, or hold the valve at its current position.

Note

The RS-232 commands to open, close, or hold the valve, override the active set point control of the valve.

How To Open the Valve

To drive the valve to full open, issue the command:

O

The system responds by driving the throttle valve to full open.

How To Close the Valve

To drive the valve to full close, issue the command:

C

The system responds by driving the throttle valve to full close.

How To Halt the Valve

To halt the valve at its current position, issue the command:

H

The system responds by holding the throttle valve at its current position.

How To Set a Process Limit Relay

There are two process limit relays (also known as trip point relays) in the 651 controller. Each relay has two trip limits: a high trip limit, and a low trip limit. Refer to Table 10, page 34 for pinout of the I/O connector to determine which pins are for relay 1, and which are for relay 2. Use the appropriate pins to configure the relays for normally-open or normally-closed operation.

While the pressure remains within the specified limits, the relay is actuated (a normally-open contact closes, and a normally-closed contact opens). Whenever the pressure crosses *above* the *high* process limit, or *below* the *low* process limit, the corresponding relay becomes de-actuated (a normally-open contact opens, and a normally-closed contact closes).

How To View and Adjust a Process Limit Relay

1. To check a process limit threshold, issue the command:

Rxx

where *xx* = 10 for the low threshold for process limit 1
 11 for the high threshold for process limit 1
 13 for the low threshold for process limit 2
 14 for the high threshold for process limit 2

The 651 controller responds with the message:

Px value

where *x* = 1 for the low threshold for process limit 1
 2 for the high threshold for process limit 1
 3 for the low threshold for process limit 2
 4 for the low threshold for process limit 2
value = pressure limit

2. To change a process limit threshold, issue the command:

Px value

where *x* = 1 for the low threshold for process limit 1
 2 for the high threshold for process limit 1
 3 for the low threshold for process limit 2
 4 for the high threshold for process limit 2
value = pressure limit

How To Disable a Process Limit Relay

To disable a high limit process limit, set the step 2 *value* to full scale.

To disable a low limit process limit, set the step 2 *value* to negative full scale.

How To Check the System Status

You can issue a “system status” request to determine the state of the 651 controller. The request is:

R37

The 651 controller sends the response:

WXYZ

where X =	1 for remote control
Y =	describes the state of the learn function: 0 when not performing the learn function 1 when learning the system 2 when learning the valve
Z =	0 = open 1 = close 2 = stop 3 = set point A 4 = set point B 5 = set point C 6 = set point D 7 = set point E 8 = analog set point

How To Check the Firmware Version

To determine the firmware version, issue the request:

R38

The 651 controller sends the response:

H *version*

Digital Logic Control

Digital and analog control of the 651 unit is accomplished via the I/O connector located on the rear panel. Refer to Table 10, page 34, for the pinout of the I/O connector.

Note



Any RS-232 command takes priority over digital logic commands. For example, a valve being held closed with a digital logic command can be commanded to control to the level of set point A with the **D1** command.

Digital *inputs* and *outputs* are designed to interface with low power TTL and CMOS logic families. They also include additional components to protect against damage from ESD or transient voltages. A brief description of the digital circuitry of the I/O board is provided in the following section.

I/O Board Digital Circuitry

The I/O board contains 16 type 74HC *inputs*. To select an input function, pull the appropriate input pin low (0 to 0.8 Volts). The TTL low signal is “level sensitive” meaning that once the signal is held low, the 651 unit may take up to 50 milliseconds to recognize the command. The line must be held low *continuously* for the 651 unit to use the selected parameters. Once the signal goes high, the instrument will default back to the state associated with the high signal within 50 milliseconds. Each input consists of a single pole filter and pull-up resistor as shown in Figure 6.

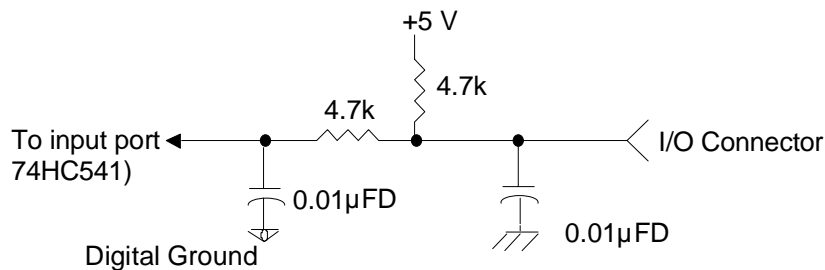

Figure 6: I/O Board Digital Input Circuitry

The I/O board contains 6 type 74HC digital *outputs*, each having the capacity to drive one standard TTL load. The approximate time constant of the outputs are 2.5 microseconds. Each output includes a 240 ohms series resistor to protect it against line surges and spikes. Additionally, there is a 0.01 μ FD capacitor connected to the chassis.

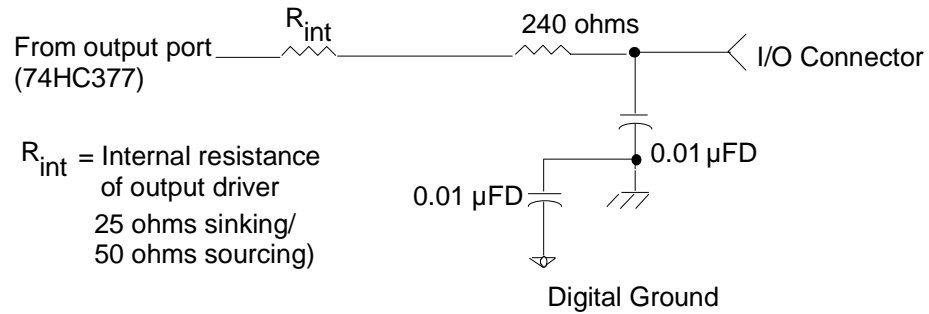

Figure 7: I/O Board Digital Output Circuitry

Digital Input Priorities

Digital inputs are scanned and selected in a prioritized manner, enabling a higher priority request to override a lower one. The order of priority is shown in Table 16.

Priority of Digital Inputs		
Order of Priority	I/O Pin No.	Digital Input Function
1	6	Analog set point (pressure or position)
2	10	Control range of analog set point
Note: Below this point, if any of the digital inputs are held low, lower priority signals are blocked; that is, they are not recognized until the higher priority signal is released.		
3	25	Remote zero
4	5	Learn system
5	8	Close valve
6	27	Open valve
7	26	Stop valve
8	11	Select analog set point
9	16	Select set point A
10	15	Select set point B
11	14	Select set point C
12	13	Select set point D
13	12	Select set point E

Table 16: Priority of Digital Inputs

The order of priority of digital inputs is based on the analog set point line (pin 11) being tied low to continuously select it, thus blocking set points A through E, except to use their gains. Refer to *How To Set the Lead and Gain Parameters*, page 81, for more information.

Note



Activating both the *open* and *close* commands simultaneously, causes the valve to *stop*.

Digital Functions

Most digital input functions are activated by pulling the input to a TTL low level (0 to 0.8 Volts) for a minimum of 50 milliseconds. If a higher priority function has not already been selected, the requested function will be activated. When the input is brought high (+2.4 to +5 Volts), any lower priority functions that have been selected will now be activated. If no lower priority functions have been selected, the function most recently requested remains in effect. Table 17 lists the specific function of each digital input. Table 18, page 95, lists the specific function of each digital output. The first column in each table lists the I/O port number assignment.

Digital Input Functions			
I/O Port No.	I/O Pin No.	State	Digital Input Function
1	27	Low	Open the valve
		High	No function
2	8	Low	Close the valve
		High	No function
3	26	Low	Stop the valve
		High	No function
4	7	Low	Softstart is <i>active</i> for selected command function
		High	Softstart is <i>inactive</i> for selected command function (used in conjunction with another valve control function)
5	25	Low	Performs the <i>remote zero</i> function
		High	No function
6	6	Low	Analog set point to <i>position</i>
		High	Analog set point to <i>pressure</i>
7	24	Low	No function
		High	No function
8	5	Low	Performs the <i>learn</i> system function
		High	No function

Table 17: Digital Input Functions
(Continued on next page)

Digital Input Functions (Continued)			
Digital Input No.	I/O Pin No.	State	Digital Input Function
9	16	Low High	Selects set point A No function
10	15	Low High	Selects set point B No function
11	14	Low High	Selects set point C No function
12	13	Low High	Selects set point D No function
13	12	Low High	Selects set point E No function
14	11	Low High	Selects analog set point No function
15	10	Low High	F.S. analog set point yields 1/10 the F.S. pressure of the controlling transducer or 10% position F.S. analog set point yields F.S. pressure of the controlling transducer or 100% position (Pressure/position function controlled by input 6)
16	9	Low High	No function No function

Table 17: Digital Input Functions

Digital Output Functions			
Digital Output No.	I/O Pin No.	State	Digital Output Function
1	29	Low	Pressure outside of PLO 1 band (relay is <i>not</i> energized)
		High	Pressure inside of PLO 1 band (relay <i>is</i> energized)
2	28	Low	Pressure outside of PLO 2 band (relay is <i>not</i> energized)
		High	Pressure inside of PLO 2 band (relay <i>is</i> energized)
3	23	Low	Valve is not closed
		High	Valve is closed
4	19	Low	Valve is not open
		High	Valve is open
5	18	Low	No function
		High	No function
6	17	Low	No function
		High	No function

Table 18: Digital Output Functions

Analog Set Point Inputs

The analog set point inputs, +set point (I/O pin 33) and -set point (I/O pin 34) on the I/O connector, are fully differential. The -set point must be connected to a ground to work correctly, and it is recommended that it be connected to ground at the source of the set point signal.

To achieve softstart control of analog (or digital logic) set points, the *softstart line* (I/O pin 7) *must be held low*. If the line is *not* held low, the valve will move at 100% full speed.

If an analog set point is established via RS-232 input, the softstart rate for the analog set point is selected through use of the **I6value** RS-232 command.

This page intentionally left blank.

Chapter Seven: Battery-Backed Memory Module

Replacing the Battery-Backed Memory Module

The 651 pressure controller has a battery-backed memory module which stores configuration and *learned* system information while power is off. The battery-backed memory module (MKS part no. 037-9227) is specified to provide at least seven years of memory storage under all operating conditions. No maintenance should normally be required during this period.

Note

The module is also available from the following sources:

- Bench Marq (BQ 4011MA-100)
 - SGS-Thompson (MK 48Z32B-10)
 - Dallas Semiconductor (DS 1230AB-100)
-

Eventually, the memory module will need to be replaced. If the 651 unit continually requires relearning at each power cycle (power off then on again), it may be time to replace it. The memory module is located on the CPU board inside the electronics unit and may be replaced by MKS or other qualified personnel.

Opening the Unit

Warning

The 651 unit has lethal voltages inside. Servicing of the unit must be performed by qualified personnel only.

To avoid an electrical shock, disconnect the power line *before* opening the unit.

1. Turn the power off.
2. Disconnect the AC power cord.

Caution

To avoid damage to sensitive internal components, personnel should be grounded through a safety impedance while working inside the 651 unit, and the unit itself must be static-free.

3. Remove the two Phillips screws located at the top of the rear panel.
4. Disengage the cover from the rear chassis by lifting it up from the clips.
5. Remove the top cover by firmly pulling it up and back to clear the top of the connector plates.

Removing the CPU Board and Memory Module

1. Locate the CPU board.
It is labeled on the rear panel as the Serial Interface connector (in slot 1).
2. Remove the screw to the left of the connector.
3. It may be necessary to remove the clamping spring that holds the card cage to the power supply. If so, use needle-nose pliers or a screwdriver to pull the clamping spring straight back and out.
4. Grasp each end of the board and rock it until it loosens from its position. Lift the board up and out of the unit.
5. Figure 8 provides the location of the battery-backed memory module on the CPU board.

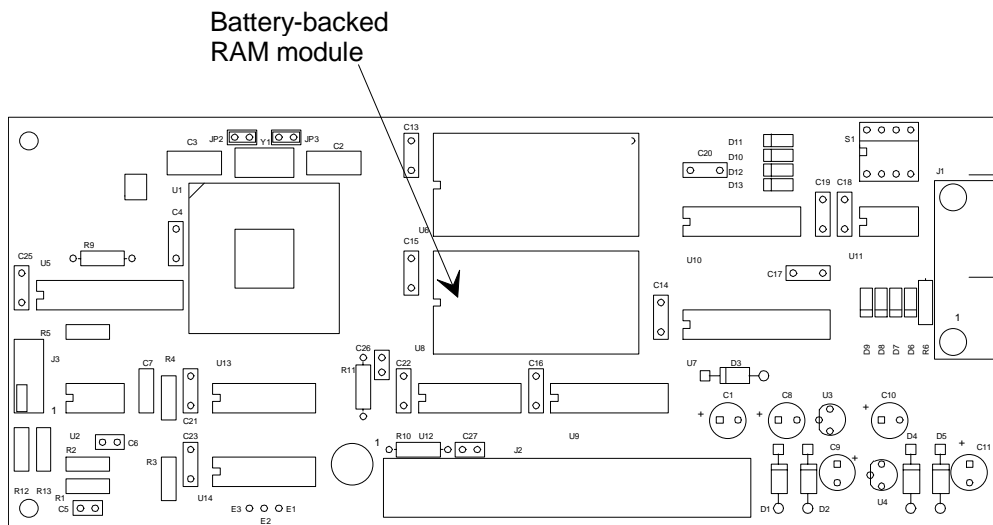

Figure 8: Location of the Battery-backed RAM Module

6. Use needle-nose pliers, a screwdriver, or an IC puller to remove the memory module from its socket.

Installing a New Memory Module and Replacing the CPU Board

1. Position the new memory module over the socket, being careful to line up the pins correctly (pin 1 is located directly to the left of the notch). Snap the module firmly into place.
2. Position the CPU board over its slot in the unit, ensuring that the board's edge is behind the next connector's edge. Push on the bottom tab to snap the board into the slot.
3. Use any instrument to gently seat the clamping spring firmly in place. A metal tab prevents the spring from sliding in completely. (The space left by the tab enables a small screwdriver to be inserted into the space for easy board removal the next time.)

Replacing the Cover

1. Using the clips on the cover as a guide, slide the cover (from rear to front) into place at the front panel.
2. Position the cover so that the cover slots engage the top of the connector plates. From the front (looking at the top of the unit toward the rear), push the cover toward the front while incrementally tightening the screws. (This ensures good electrical connection between the top cover and rear connector plates.)
3. Reconnect the AC power cord.
4. Turn the power on.

Note

All user configuration settings may have to be reset and the control system may have to be relearned after replacement of the memory module.

This page intentionally left blank

Chapter Eight: Valve Failsafe Battery Back-up Option

General Information

An optional Valve Failsafe Battery Back-up (lead-acid battery) provides full valve drive capability for approximately 30 seconds after an AC power failure. The 651 instrument can be set to drive the valve open, closed, or hold it in its current position upon a power loss. This battery is a rechargeable, 12 Volt, 2 amp-hour, sealed lead-acid battery (MKS part no. 003-1109451).

Note



The lead-acid battery is also available from the following sources:

- Power Sonics (PS-1220)
 - Panasonic (LCR 12 V2.2P)
-

This chapter provides instructions on how to check your controller to ensure that it recognizes when the battery back-up module is present, and how to configure the valve position upon a power loss when using either Local or Remote operation.

If a Valve Failsafe Battery Backup is installed, an **ATTENTION** label is affixed to the side of the 651 unit. The label states that the unit contains a lead-acid battery which is maintained in a properly charged state while the instrument is powered on. Basic maintenance information is also provided. Since the lead-acid battery is continually recharged while the 651 unit is powered and operating, the battery is typically maintenance free and needs attention only when it must be replaced. The upper limit of the ambient temperature range of a 651 unit, equipped with a Valve Failsafe Battery Back-up option is 35° C versus 40° C for a unit without the option.

Note



If a Valve Failsafe battery backup is ordered for a 651A or 651B unit, the unit must be sent back to your local MKS Service Center to have the battery backup system installed. Before returning the instrument to MKS, obtain an ERA Number (Equipment Return Authorization Number) from an MKS Service Center.

Battery Voltage

The normal voltage level of the battery ranges from 11 V to 15.5 V. A voltage level *below* 11 V indicates a discharged battery. A voltage level *above* 15.5 V indicates an open fuse, a disconnected battery, or a defective charger.

Valve Positions

The controller can be configured so that the valve will be driven fully open, fully closed, or will be disabled upon an AC power failure.

Open: The controller opens the valve at power down. In the event that the valve is already open, the module provides power for approximately 1 second before turning off.

Closed: The controller closes the valve at power down. In the event that the valve is already closed, the module provides power for approximately 1 second before turning off.

Disable: The option is disabled and will not perform any function at power down. The controller turns off in a normal manner.

When the controller is configured to open or close the valve, it will perform the operation whenever power to the controller is turned off, regardless of whether the power is turned off via the power switch or by a power failure.

Note

If for any reason the controller cannot open or close the valve within 30 seconds of a power failure, the battery back-up module automatically turns off. This prevents the battery from discharging when no valve is present or if the valve is defective in some way.

Startup

Threshold Voltage Check

When the 651 controller is turned on, it measures the voltage at the input port assigned to the battery back-up module. When the voltage level at the port exceeds a factory set minimum threshold value, the controller recognizes that the battery back-up is present, and the software menus which support the module are installed. Should the voltage level be below the threshold, the controller does not recognize the module and the software menus are not installed.

Once the 651 unit has been powered up and the battery back-up module has been recognized, the actual voltage of the battery is measured.

Battery Voltage Within Range

If the battery voltage is within the acceptable range of 11 V to 15.5 V, the instrument revision and the current software/firmware version appears on the front panel display for about five seconds, before advancing to the default *Pressure and Position* screen:

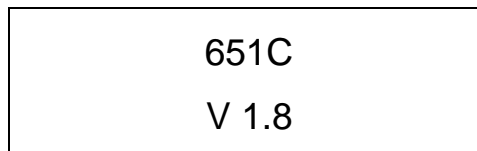

Figure 9: Initial Display Screen

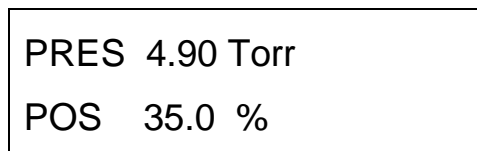

Figure 10: Default Pressure and Position Screen

The controller is now ready for valve connection and setup (or normal operation once the system has been configured). The 651 unit does not display a status screen to indicate that the battery voltage is within range.

Battery Voltage Out-of-Range

If the battery voltage is out-of-range, the instrument revision and the current software/firmware version appears on the front panel display for about five seconds (refer to Figure 9, page 103), followed by the appropriate error message, rather than advancing to the default *Pressure and Position* display screen (refer to Figure 10, page 103).

If the battery voltage is below 11 V, the screen displays:

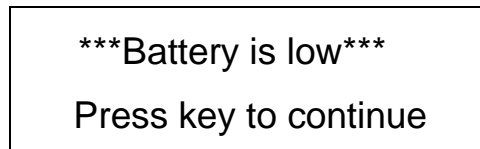

Figure 11: Battery Voltage Low Message

If the battery voltage is above 15.5 V, the screen displays:

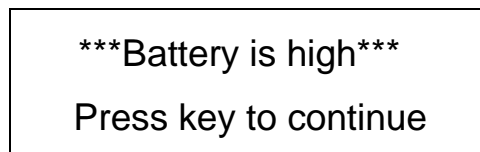

Figure 12: Battery Voltage High Message

The system allows for continued operation when the battery voltage is out-of-range, since your process may not require that the battery voltage level be addressed immediately. To continue operation, press any key to advance to the default *Pressure and Position* display screen.

Note

It is important to note that in addition to supporting the controller's valve position, the battery back-up feature powers the controller, and any pressure transducer or valve connected to it.

Operation

How To Check the Battery Voltage

To ensure that the 651 unit has recognized the battery back-up module, or to view the actual battery voltage and the current valve configuration without entering the software menus (regardless of whether you are using Local or Remote operation):

1. Ensure that the default *Pressure and Position* screen appears on the display:

PRES	4.90 Torr
POS	35.0 %

2. Press the [▽] key one time.

If the battery back-up module has been recognized, the screen displays:

BATTERY	13.5V
BACK-UP:	OPEN

This screen allows you to view the actual battery voltage and the current valve configuration. The valve configuration cannot be changed from this screen. Refer to *How To Set The Battery Back-up Valve Control*, page 106, for instructions on how to change the valve configuration; the battery voltage cannot be adjusted. Press any key to return to the default *Pressure and Position* screen.

If the battery back-up module has *not* been recognized, the screen reverts to the initial display screen which lists the instrument revision and the current software/firmware version:

651C
V 1.8



Press any key to return to the default *Pressure and Position* screen.

How To Set The Battery Back-up Valve Control

Local Operation



1. Ensure the Key Lock Switch is set to Local and that the default *Pressure and Position* display appears on the screen.

PRES 4.90 Torr
POS 35.0 %

2. Press the  and  keys simultaneously for about 3 seconds to enter the Setup menu.

The screen displays:

CONTROL
MODE: PID

3. Press the  or  down arrow key to scroll through the menu until the battery back-up option selection screen appears on the display.

The screen displays:

BATTERY 13.5V
BACK-UP: OPEN

The screen displays the actual voltage level of the battery along with the position the valve is currently set to drive to upon a power loss.

Select whether the valve will be driven fully open, fully closed, or will be disabled upon an AC power failure by turning the Adjust knob on the front panel to the desired setting. Choose from the options of open, closed, or disable (initial).

Note

Press any key to exit the Setup menu and return to the default *Pressure and Position* display screen.

Remote RS-232 Operation

The command [**K** *value*] defines the direction of valve control upon power failure, where:

value: 0 = disable option
1 = open valve at power failure
2 = close valve at power failure

To check the type of valve battery back-up control, issue the request:

R 40

The controller responds with the message [**K** *value*], where:

value: 0 = option disabled
1 = valve opens at power failure
2 = valve closes at power failure

An example response, if the valve is set to open upon a power failure, is:

K 1

To change the valve control so that it closes upon a power failure, enter:

K 2

Expected Battery Life

When AC power is lost, the valve battery backup drives the valve to full open or full closed within 20 seconds. An AC power failure typically results in a 30% discharge of the battery. Under this condition, the battery life is at least 1000 cycles, and should be able to recharge within a few hours after power returns. Battery life under several conditions is listed in Table 19.

Expected Battery Life	
Expected Cycles	% Discharge with each Battery Use
1000	30
400	50
200	100
2-3 years if unused and charge is maintained	

Table 19: Expected Battery Life

When AC power returns, the battery recharges, provided that the 651 instrument is turned on. From a full discharge condition, the voltage typically increases from about 11 V to 15.5 V over a five hour period. The voltage is maintained at about 14.5 V for another five hours then gradually drops to 13.5 V. The 13.5 Volt charge is maintained in a trickle charge state (a top charged state) until there is an AC power failure. The recharge time for a completely discharged battery is a maximum of 12 hours.

Battery Storage

The lead-acid battery loses its capacity if it is stored with no power connected. In fact, the higher the ambient temperature, the faster the capacity is lost. Table 20 shows the time it takes for the battery to fall to fifty percent of its full capacity at various ambient temperatures.

Capacity Loss of Stored Battery	
Ambient Temperature (° C)	No. Days to 50% Capacity
20	500
30	250
40	150
50	75

Table 20: Capacity Loss of Stored Battery

Battery Replacement

Opening the Unit

Warning



The 651 unit has lethal voltages inside. Servicing of the unit must be performed by qualified personnel only.

To avoid an electrical shock, disconnect the power line *before* opening the unit.

1. Turn the power off.
2. Disconnect the AC power cord.

Caution



To avoid damage to sensitive internal components, personnel should be grounded through a safety impedance while working inside the 651 unit, and the unit itself must be static-free.

3. Remove the two Phillips screws located at the top of the rear panel.
4. Disengage the cover from the rear chassis by lifting it up from the clips.
5. Remove the top cover by firmly pulling it up and back to clear the top of the connector plates.
6. Locate the area of the unit where the chassis splits (to the rear of the front panel) and remove the two screws on both sides of the front panel as well as the two screws on both sides of the battery backup housing.
7. Slide the front panel out far enough to enable the ribbon cable to lay flat.
8. Slide the battery backup housing out about an inch.
9. Disconnect the battery power bus interface from the battery backup circuit board.
10. Unsnap the ribbon cable connector.
11. Pull both the front panel module and the battery backup housing away from the card cage/power assembly.
12. Remove the screw located on the left side of the housing.
13. Orient the housing on its side, and remove the two visible screws.

14. Pull the front panel module completely forward and remove the battery circuit board assembly.

Installing the New Battery

1. Disconnect the two insulated clips from the battery terminals.

Caution



Do not allow anything to short across the battery terminals; for example, a screwdriver.

2. Push the battery straight up (from underneath) and out.
3. With the new battery positioned such that the terminals are at the rear and + is on the right-hand side, reconnect the two insulated clips.
Be sure that + is connected to + and - is connected to - .
4. Feed the ribbon cable through the slot.
Be sure to keep the cable away from the heatsink.
5. Replace the two screws that attach the circuit assembly to its chassis and the screw removed from the left side of the housing.
6. Position the front panel module and battery backup housing so that the ribbon cable connector can be plugged into the card cage.
7. Plug the bus connector into the circuit board located in the battery backup housing.
8. Slide the battery backup housing into position and snap it into place.
9. Replace the two screws on each side of the battery backup housing.
10. Push the front panel module slightly back and fold the ribbon cable.
11. Slide the front panel module into the battery backup housing and snap into place.
12. Replace the two screws on both sides of the front panel module.
13. Replace the top cover and its two screws.

The unit is now ready to be plugged in and powered up.

Chapter Nine: Maintenance

General Information

If the 651 instrument fails to operate properly upon receipt, check for shipping damages, and check the cables for continuity. Any damage should be reported to the carrier and MKS Instruments immediately. If it is necessary to return the unit to MKS, obtain an ERA number (Equipment Return Authorization Number) from a MKS Service Center before shipping. Please refer to the inside back cover of this manual for a list of MKS Calibration and Service Centers.

Periodically, check for wear on the cables and inspect the enclosure for visible signs of damage.

How To Replace Fuses

1. Select the proper fuses.

All units should have two fuses installed to *fuse both sides* of the line.

2. Disconnect the power cord from the 651 instrument.

Warning

To avoid an electrical shock, be sure to disconnect the power cord *before* proceeding.

3. Insert a small device, for example, a screwdriver, in the fuse holder clip on the right side of the fuse holder.

Refer to Figure 13, page 112, for the location of the clip.

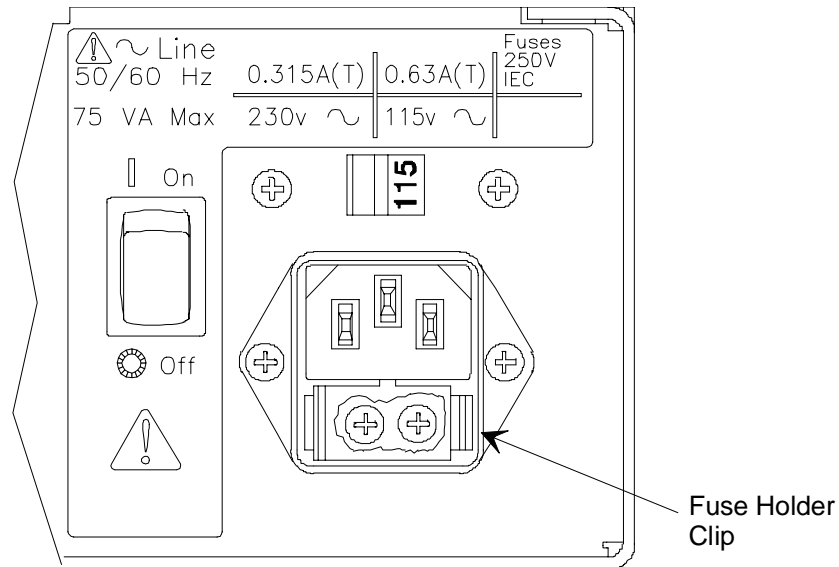

Figure 13: Fuse Holder

4. Gently press against the clip and push up with the screwdriver until the plastic fuse holder pops out.
It may be necessary to repeat steps 2 and 3 on the left side to release the fuse holder.
5. Replace the old fuses with new ones and gently snap the fuse holder back into place.

Appendix A: Product Specifications

Ambient temperature	15° to 40° C (60° to 104° F) 15° to 35° C (60° to 95° F) with optional valve failsafe battery backup
Analog output signal Position Pressure	0 to 5 Volts or 0 to 10 Volts, selectable 0 to 100% F.S. pressure, same range as sensor
CE Compliance Electromagnetic Compatibility ¹ Low-Voltage Requirements Installation Category Pollution Degree Product Safety Requirements	EMC Directive 89/336/EEC Low-Voltage Directive 73/23/EEC II, according to EN 61010-1 2, according to IEC 664 Product Safety Directive 92/59/EEC
Controller repeatability	±0.1% of F.S.
Connectors ² Valve I/O Transducer RS-232 Serial Communications	9-pin Type “D” female 37-pin Type “D” female 15-pin Type “D” female 9-pin Type “D” male
Display	2 line LCD with 4½ place readout
Display units	Torr, mTorr, mbar, µbar, Pascal, kPa, cmH ₂ O, inH ₂ O
External set point signal	0 to 5 Volts or 0 to 10 Volts, selectable
Fuses Low power unit: 90 to 132 VAC 180 to 264 VAC High power unit: 90 to 132 VAC 180 to 264 VAC	0.63A (T), 250V, 5 x 20 mm 0.315A (T), 250V, 5 x 20 mm 1.25A (T), 250V, 5 x 20 mm 0.63A (T), 250V, 5 x 20 mm

¹An overall metal braided shielded cable, properly grounded at both ends, is required during use.

²Interconnecting cables between the Type 651 and the valve, sensor, and serial communications are available at an additional charge. Please consult factory for ordering information. Necessary adapter cables are included when retrofitting MKS Type 152, 252, and 652 controllers.

<p>Input power</p> <p>Low power unit</p> <p>High power unit</p>	<p>90 to 132 or 180 to 264 VAC @50/60 Hz 75 VA (max)</p> <p>90 to 132 or 180 to 264 VAC @48/62 Hz 150 VA (max)</p>
<p>Interface</p> <p>RS-232</p> <p>Analog</p> <p>Digital</p>	<p>Inputs (16): HCMOS pulled high with a 4.7k resistor to be TTL compatible. Driver must sink 1 mA and hold low for > 50 msec to select function.</p> <p>Outputs (6): HCMOS with 240 ohm series protection resistor. Will sink & source 1 TTL load. Time constant < 500 nanoseconds.</p>
<p>Output power</p> <p>Low power unit</p> <p>High power unit</p>	<p>±15 VDC @ 0.5 Amps (max)³</p> <p>±15 VDC @ 1.5 Amps (max)</p>
Overrange pressure	±10.5 Volts
Pressure input signal	-10 to 10 Volts
Process limit relays (2)	24 Volts AC/DC @ 1 Amp resistive (contact ratings)
<p>Set points</p> <p>Internal</p> <p>External</p>	<p>5, each one pressure or position selectable</p> <p>1, pressure or position selectable</p>
<p>Size</p> <p>with optional valve failsafe battery backup</p>	<p>3½”H x 9½”W x 9”D (8.9 cm x 24.1 cm x 22.9 cm)</p> <p>12”D (30.5 cm)</p>
<p>Weight</p> <p>Low power unit</p> <p>High power unit</p>	<p>7 lbs. 3 oz. (3.26 kg)</p> <p>6 lbs. (2.04 kg)</p> <p><i>plus</i> 3 lbs. 8 oz. (1.25 kg) for optional valve failsafe battery backup</p>

Due to continuing research and development activities, these specifications are subject to change without notice.

³Derated to 0.4 Amps with 90 to 99 or 180 to 198 VAC input.

Appendix B: Model Code Explanation

Model Code

The desired options for the 651 controller are identified in the model code when you order the unit.

The model code is identified as follows:

651C X Y Z C D

where:

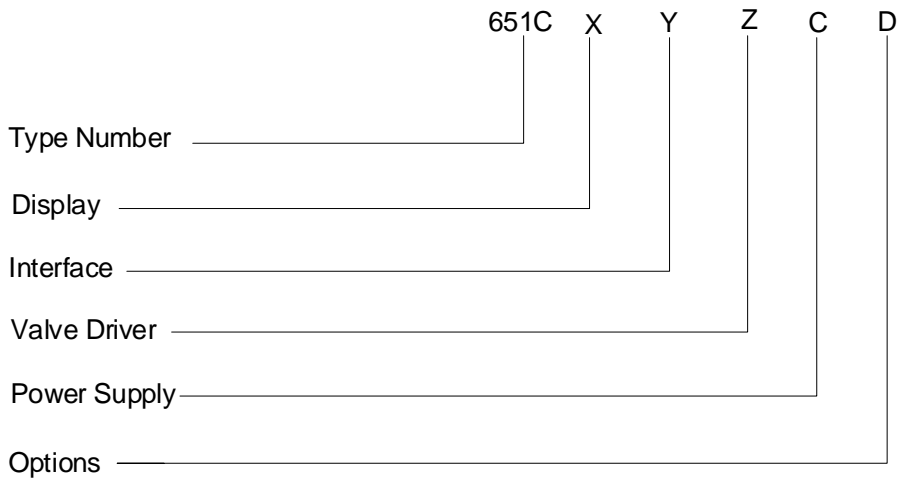

Type Number (651C)

This designates the model number of the instrument.

Display (X)

The display on your 651 unit is designated by a single letter code.

	Ordering Code
No Display	N
Display	D

Interface (Y)

The type of interface is indicated by a single digit code.

	Ordering Code
RS-232	2

Valve Driver (Z)

The valve driver is designated by a single letter code.

	Ordering Code
Stepper Motor	S

Power Supply (C)

Two power supplies are available, designated by a single number code.

	Ordering Code
0.5 Amp	1
1.5 Amp	2

Options (D)

The battery back-up for valve control is designated by a single letter code.

	Ordering Code
None	N
Battery Back-Up	B

Appendix C: Product Compatibility

Product Compatibility

Valves

MKS *downstream* control valves compatible with the 651 unit include:

Types 253 and 653

Transducers

Table 21 lists the current available to a transducer from a 651 controller (and its specific valve configuration).

Transducer Current Available from Low and High Power Units			
Valve Configuration	651 Supply Type	Line Voltage Range	Transducer Current Available
253/653	Low power	90 to 99 VAC 50/60 Hz	400 mA
		180 to 198 VAC 50/60 Hz	400 mA
		100 to 132 VAC 50/60 Hz	500 mA
		200 to 264 VAC 50/60 Hz	500 mA
253/653	High power	90 to 132 VAC 48/62 Hz	1.5 A
		180 to 264 VAC 48/62 Hz	1.5 A

Table 21: Transducer Current Available from Low and High Power Units

MKS transducers compatible with the *low power* 651 unit include:

Types 122, 124, 127, 128⁴, 220, 121, and 223.

MKS transducers compatible with the *high power* 651 unit include:

Types 120, 122, 124, 127, 128, 220, 121, 223, and 621.

⁴To ensure proper operation of the Type 128 transducer in the (90 to 99/180 to 198) power line voltage range, it is recommended that the *high power* 651 unit be used. Above 100/200 volts, the *low power* unit provides adequate power.

Adapter Cables

The 651 Pressure Controller can replace the 152, 252, and 652 controllers. It may, however, be necessary to fit the Type “D” connectors on the 651 unit with adapter cables. Refer to Table 22 for a listing of the appropriate cable numbers.

651 Adapter Cables		
From	To	Cable Number
252, 252+VPO 252+MSO	651 I/O 651 I/O	CB651-12-1 CB651-13-1
252+PLO 252+PLO+VPO	651 I/O	CB651-14-1
252+MSO+PLO 252+MOS+VPO 252+MSO+VPO+PLO	651 I/O	CB651-15-1
152 PC/VPO 152 PC/VPO+RS-232	651 I/O	CB651-16-1
152 RZ/VPO RZ/VPO+RS-232	651 I/O	CB651-17-1
152/252 Sensor Cables	651 Sensor	CB651-18-1
25-Pin Serial Cable ⁵	651 Serial	CB651-19-1
652 I/O	651 I/O	CB651-20-1
152/252 Valve Cable	651 Valve	CB652-2-1

Table 22: 651 Adapter Cables

Note



The RS-232 serial communication cables are listed in Table 9, page 33.

⁵Pins 2 and 3 not reversed. This cable is a 651 to 652 serial port converter cable. The 25-pin end simulates a 652 controller, and the opposite end connects to the 651 serial port.

Appendix D: Type 651 Displayless Unit

Type 651 Displayless Unit

The displayless unit is a standard 651 unit with the following differences:

- There is no front panel display
- An additional RS-232 serial port, located on the front panel, is intended to be used in conjunction with a laptop or notebook computer
- The baud rate is set at 9600 with no parity, 8 data bits, 1 stop bit, and [CR][LF] delimiter

To put the 651 displayless unit into operation via the RS-232 port on the front panel, set the Key Lock switch to the Local position. When the Key Lock switch is set to the Local position, TTL input and the rear serial communications port become locked out. Conversely, when the Key Lock switch is set to the Remote position, the front serial communications port becomes locked out, and the unit can be controlled either by TTL input or through the serial communications port on the rear panel.

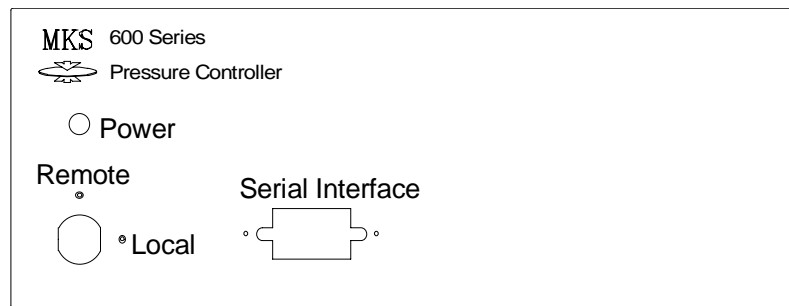

Figure 14: Front Panel of the 651 Displayless Unit

RS-232 Configuration

Since the displayless 651 controller cannot use the Setup menu to change the controller's RS-232 configuration, changes can be made by means of internal dipswitch settings.

Note



If a 651 controller has a front panel display, use the Setup menu to change the RS-232 configuration, described in *Setup Menu*, page 41.

The RS-232 configuration setting defined in the Setup menu override dipswitch settings.

Internal Switches

A dipswitch bank inside the 651 unit allows you to customize RS-232 communications parameters. The dipswitch bank is located on the I/O board.

Opening/Closing the Type 651 Controller

1. Turn the power off.
2. Remove the Phillips screws and washers on the top panel.

Caution



Be sure to be grounded while you are working on internal components of the 651 unit. This precaution will avoid damage to sensitive internal components of the unit.

3. Remove the top cover by firmly pulling it up and towards the back of the unit.

The dipswitch bank is now accessible.

After changing the dipswitch settings, replace the cover on the unit and replace the screws and washers you removed in step 2, above. After verifying that the unit is properly reassembled, power up the 651 controller. The new dipswitch settings will be recognized.

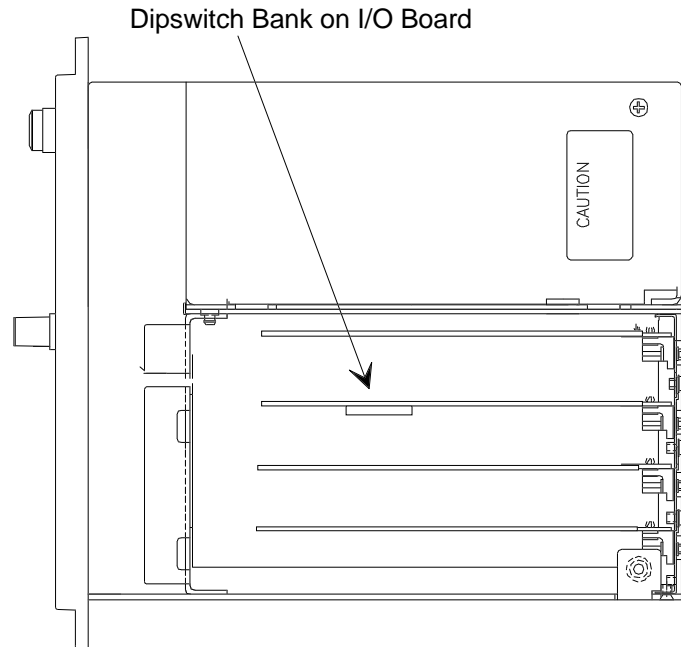

Figure 15: Dipswitch Bank Location (Top View)

The dipswitch bank is located on the I/O board, shown in Figure 15. You can also identify the I/O board by locating the I/O connector on the rear panel (refer to Figure 4, page 31).

Figure 16, shows an enlarged view of a dipswitch bank. The switches in the dipswitch bank are numbered from 1 to 8. The dipswitch bank has the word **OPEN** written on it. To set a dipswitch to open, push it toward the **OPEN** label. To set a dipswitch to closed, push it away from the **OPEN** label. For example, in Figure 16 all of the switches are closed.

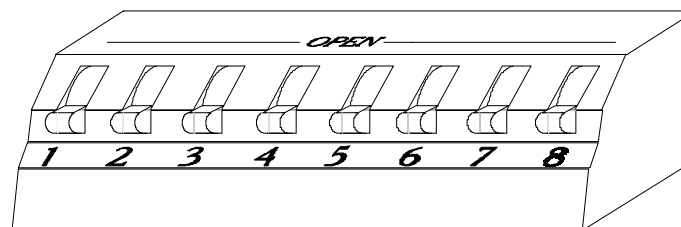

Figure 16: Example of Dipswitch Bank

Dipswitch Bank Settings

The dipswitch settings control the RS-232 communications parameters. When you receive your 651 controller, the unit is set up with the initial dipswitch settings listed in Table 23.

Default Dipswitch Settings		
Dipswitch	Setting	Function
Switch 1, 2, 3	Closed	9600 Baud Rate
Switch 4	Open	
Switch 5	Closed	Parity - None, 8 data bits
Switch 6	Closed	Reserved*
Switch 7	Closed	Reserved*
Switch 8	Closed	End-of-Line Delimiter CRLF

** The "Reserved" pin assignment refers to a pin with an internal connection which may be assigned a function in the future.*

Table 23: Default Dipswitch Settings

Note



Parity and data bit setting are dependent. You may select either no parity with 8 data bits or even parity with 7 data bits.

There is no stop bit setting. RS-232 communications uses 1 stop bit under all circumstances. This setting *cannot* be changed.

If the initial settings, listed in Table 25, page 125, are not appropriate for your application, refer to Table 24, page 123, for switch settings you can use to change the baud rate, parity and data bits, and end-of-line delimiter.

Caution

Before opening the unit to change dipswitch settings, you must power off the unit as a safety precaution. Refer to *Opening/Closing the Type 651 Controller*, page 120. Any new dipswitch settings take effect when the unit is powered up.

I/O Board Dipswitch Bank and RS-232 Communications Settings						
Function	Choices	Switches				
RS-232 Baud Rate		1	2	3	4	
The five choices for baud rate are:	300	O	C	O	O	
	1200	O	O	C	O	
	2400	O	O	O	C	
	4800	O	C	C	O	
	9600	C	C	C	O	
RS-232 Parity and Data Bits					5	
The two choices for parity checking are:	Even 7 data bits					O
	None 8 data bits					C
Reserved Switches					6	7
Reserved for future use.					C	C
RS-232 End-of-Line Delimiter						8
The two choices for end-of-line delimiter are:	CR					O
	CRLF					C
<i>Note: O = Open C = Closed</i>						

Table 24: I/O Board Dipswitch Bank and RS-232 Communications Settings

This page intentionally left blank.

Appendix E: Initial Settings

Your 651 controller is shipped with the following initial configuration. This configuration is not a default configuration, however, since the 651 unit stores most of the configuration settings in non-volatile RAM. Settings stored in non-volatile RAM are not lost when the power is turned off. When the power is restored, the 651 unit “remembers” the latest configuration, not the initial configuration. Refer to Table 25 for a complete list of the initial configuration settings. The last column lists the page number for information on each entry, should you wish to change the setting.

Initial Settings			
Parameter	Default	Options	Page
Control Valve	653	253 Fast, 253 Standard	64
Control Mode	PID	Self Tuning	41
Internal Set points	A Pressure B Pressure C Pressure D Pressure E Pressure	Position Position Position Position Position	74
Gain and Lead Values	A Gain = 100 Lead = 10 B Gain = 100 Lead = 10 C Gain = 100 Lead = 10 D Gain = 100 Lead = 10 E Gain = 100 Lead = 10	User selectable	
Line Voltage (VAC)	115 VAC	230 VAC	25
Sensor Full Scale (Torr)	100	10000, 5000, 1000, 10, 2, 1, 0.1	66

Table 25: Initial Settings
(Continued on next page)

Initial Settings (Continued)			
Parameter	Default	Options	Page
Display Units	Torr	mTorr, mbar, μ bar, Pa, kPa, cmH ₂ O, inH ₂ O	44
Analog Set point Input	0 to 5 V	0 to 10 V	45
Pressure Sensor Input	0 to 10 V	0 to 5 V, 0 to 1 V	44
Analog Output	Pressure: 0 to 10 V Position: 0 to 10 V	No option 0 to 5 V	45
Control Mode	Direct Acting	Reverse	86
RS-232			42
Baud Rate	9600	4800, 2400, 1200, 300	120
Parity/Data Bits	None/8	Even/7	
Delimiter	CRLF	CR	
Battery Backup Failsafe Mode	None	Close valve, Open valve, Disable	101

Table 25: Initial Settings

Appendix F: Command and Request Reference

Command Reference

A *command* sent to the 651 unit instructs it to perform a task or change a setting. Commands are grouped into two categories: *control commands* and *parameter commands*.

Control commands directly control the actions of the valve. Valve open, valve close, and valve halt, as well as selection of the controlling set point, are examples of control commands.

Parameter commands determine the settings used by the 651 controller. Set point levels, softstart rates, and sensor full scale are examples of parameter commands.

Note

To conserve space, the key is not included in the request messages listed the following tables. You must press the key to send the request message to the 651 controller.

Enter commands without spaces. Spaces are used in the manual to improve readability.

RS-232 command syntax is shown in Table 26, page 128.

RS-232 Command Summary	
Command	Function
S1 <i>value</i>	Set level of set point A; where <i>value</i> is the % of F.S. pressure for pressure set points; position for position set points % of open for direct direction control % of closed for reverse direction control
S2 <i>value</i>	Set level of set point B; where <i>value</i> is the % of F.S. pressure for pressure set points; position for position set points % of open for direct direction control % of closed for reverse direction control
S3 <i>value</i>	Set level of set point C; where <i>value</i> is the % of F.S. pressure for pressure set points; position for position set points % of open for direct direction control % of closed for reverse direction control
S4 <i>value</i>	Set level of set point D; where <i>value</i> is the % of F.S. pressure for pressure set points; position for position set points % of open for direct direction control % of closed for reverse direction control
S5 <i>value</i>	Set level of set point E; where <i>value</i> is the % of F.S. pressure for pressure set points; position for position set points % of open for direct direction control % of closed for reverse direction control
S6 <i>value</i>	Set F.S. level of analog set point 0 = 100% of controlling transducer's range 1 = 10% of controlling transducer's range
D1	Select set point A
D2	Select set point B

Table 26: RS-232 Command Summary
(Continued on next page)

RS-232 Command Summary (Continued)																					
Command	Function																				
D3	Select set point C																				
D4	Select set point D																				
D5	Select set point E																				
D6	Select analog set point																				
E value	<p>Sensor range <i>value</i></p> <table> <tr> <td>0 = 0.1</td> <td>10 = 1000</td> </tr> <tr> <td>1 = 0.2</td> <td>11 = 5000</td> </tr> <tr> <td>2 = 0.5</td> <td>12 = 10000</td> </tr> <tr> <td>3 = 1</td> <td>13 = 1.33</td> </tr> <tr> <td>4 = 2</td> <td>14 = 2.66</td> </tr> <tr> <td>5 = 5</td> <td>15 = 13.33</td> </tr> <tr> <td>6 = 10</td> <td>16 = 133.3</td> </tr> <tr> <td>7 = 50</td> <td>17 = 1333</td> </tr> <tr> <td>8 = 100</td> <td>18 = 6666</td> </tr> <tr> <td>9 = 500</td> <td>19 = 13332</td> </tr> </table>	0 = 0.1	10 = 1000	1 = 0.2	11 = 5000	2 = 0.5	12 = 10000	3 = 1	13 = 1.33	4 = 2	14 = 2.66	5 = 5	15 = 13.33	6 = 10	16 = 133.3	7 = 50	17 = 1333	8 = 100	18 = 6666	9 = 500	19 = 13332
0 = 0.1	10 = 1000																				
1 = 0.2	11 = 5000																				
2 = 0.5	12 = 10000																				
3 = 1	13 = 1.33																				
4 = 2	14 = 2.66																				
5 = 5	15 = 13.33																				
6 = 10	16 = 133.3																				
7 = 50	17 = 1333																				
8 = 100	18 = 6666																				
9 = 500	19 = 13332																				
F value	<p>Pressure units <i>value</i></p> <table> <tr> <td>0 = Torr</td> <td>1 = mTorr</td> </tr> <tr> <td>2 = mbar</td> <td>3 = μbar</td> </tr> <tr> <td>4 = kPa</td> <td>5 = Pa</td> </tr> <tr> <td>6 = cmH₂O</td> <td>7 = inH₂O</td> </tr> </table> <p><i>Note:</i> The F command merely assigns a label to the pressure units. It does not convert pressure readings. Pressure readings are % of F. S.</p>	0 = Torr	1 = mTorr	2 = mbar	3 = μ bar	4 = kPa	5 = Pa	6 = cmH ₂ O	7 = inH ₂ O												
0 = Torr	1 = mTorr																				
2 = mbar	3 = μ bar																				
4 = kPa	5 = Pa																				
6 = cmH ₂ O	7 = inH ₂ O																				
G value	<p>Sensor voltage range <i>value</i></p> <table> <tr> <td>0 = 1 Volt</td> </tr> <tr> <td>1 = 5 Volts</td> </tr> <tr> <td>2 = 10 Volts</td> </tr> </table>	0 = 1 Volt	1 = 5 Volts	2 = 10 Volts																	
0 = 1 Volt																					
1 = 5 Volts																					
2 = 10 Volts																					
O	Open valve																				
C	Close valve																				
H	Hold valve																				

Table 26: RS-232 Command Summary
(Continued on next page)

RS-232 Command Summary (Continued)	
Command	Function
I1 <i>value</i>	Set softstart rate of set point A, <i>value</i> is % of full speed
I2 <i>value</i>	Set softstart rate of set point B, <i>value</i> is % of full speed
I3 <i>value</i>	Set softstart rate of set point C, <i>value</i> is % of full speed
I4 <i>value</i>	Set softstart rate of set point D, <i>value</i> is % of full speed
I5 <i>value</i>	Set softstart rate of set point E, <i>value</i> is % of full speed
I6 <i>value</i>	Set softstart rate of analog set point, <i>value</i> is % of full speed
I7 <i>value</i>	Set softstart rate of open valve, <i>value</i> is % of full speed
I8 <i>value</i>	Set softstart rate of close valve, <i>value</i> is % of full speed
P1 <i>value</i>	Set low threshold for process limit 1 <i>value</i> is % of F.S.
P2 <i>value</i>	Set high threshold for process limit 1 <i>value</i> is % of F.S.
P3 <i>value</i>	Set low threshold for process limit 2 <i>value</i> is % of F.S.
P4 <i>value</i>	Set high threshold for process limit 2 <i>value</i> is % of F.S.
Z1	Zero the sensor
Z2 <i>value</i>	Special zero <i>value</i> is % F.S. of the base pressure reading
Z3	Remove the zero correction factors
Z4	Learn the zero of the analog set point. Assigns current value of external analog set point to zero value. If the current value of the analog set point is beyond $\pm 15\%$ of full scale, the controller ignores the command and does not change the current zero value.

Table 26: RS-232 Command Summary
(Continued on next page)

RS-232 Command Summary (Continued)	
Command	Function
Y1 <i>value</i>	Calibrate span of A/D converter; calibrate position output and zeroed pressure output. The controller will assign <i>value</i> to the converter reading of the pressure channel.
Y2	Learn the full scale of the analog set point. Assigns current value of external analog set point to the full scale value. If the current value of the analog set point exceeds $\pm 15\%$ of full scale, the controller ignores the command and does not change the current full scale value.
L	Learn the system (Self-Tuning control)
Q	Stop the learn function (while in process)
J <i>value</i>	Calibrate the valve, where <i>value</i> is: 1 = Std 253 2 = Fast 253 3 = 653
A <i>value</i>	Analog set point range where <i>value</i> is: 0 = 5 Volts 1 = 10 Volts
T1 <i>value</i>	Set point A type where <i>value</i> is: 0 = position 1 = pressure
T2 <i>value</i>	Set point B type where <i>value</i> is: 0 = position 1 = pressure
T3 <i>value</i>	Set point C type where <i>value</i> is: 0 = position 1 = pressure
T4 <i>value</i>	Set point D type where <i>value</i> is: 0 = position 1 = pressure

Table 26: RS-232 Command Summary
(Continued on next page)

RS-232 Command Summary (Continued)	
Command	Function
T5 <i>value</i>	Set point E type where <i>value</i> is: 0 = position 1 = pressure
T6 <i>value</i>	Set point analog type where <i>value</i> is: 0 = position 1 = pressure
B <i>value</i>	Valve position output range where <i>value</i> is: 0 = 5 Volts 1 = 10 Volts
N <i>value</i>	Direct/reverse control where <i>value</i> is: 0 = direct 1 = reverse
U <i>value</i>	Sensor type where <i>value</i> is: 0 = Absolute 1 = Differential
X1 <i>value</i>	Set lead of set point A, where <i>value</i> = seconds
X2 <i>value</i>	Set lead of set point B, where <i>value</i> = seconds
X3 <i>value</i>	Set lead of set point C, where <i>value</i> = seconds
X4 <i>value</i>	Set lead of set point D, where <i>value</i> = seconds
X5 <i>value</i>	Set lead of set point E, where <i>value</i> = seconds
M1 <i>value</i>	Set gain of set point A, where <i>value</i> = % gain
M2 <i>value</i>	Set gain of set point B, where <i>value</i> = % gain
M3 <i>value</i>	Set gain of set point C, where <i>value</i> = % gain
M4 <i>value</i>	Set gain of set point D, where <i>value</i> = % gain
M5 <i>value</i>	Set gain of set point E, where <i>value</i> = % gain
V0	Select Self-Tuning control
V1	Select PID control

Table 26: RS-232 Command Summary
(Continued on next page)

RS-232 Command Summary (Continued)	
Command	Function
K0	Disable battery backup
K1	Select valve to open upon power fail
K2	Select valve to close upon power fail

Table 26: RS-232 Command Summary

Request and Response Reference

A *request* to the 651 controller causes it to send back information. Refer to Table 27 for a complete list of request messages.

Note



To conserve space, the **ENTER** key is not included in the request messages listed the following tables. You must press the **ENTER** key to send the request message to the 651 controller.

Response message do not contain spaces. Spaces are used in the response messages to improve readability.

RS-232 Requests and Response Summary		
Request Message	Information Requested	Response Message
R0	Analog set point value	S0 <i>value</i> where <i>value</i> is % of F.S.
R1	Set point A value	S1 <i>value</i> . where <i>value</i> is % of F.S.
R2	Set point B value	S2 <i>value</i> where <i>value</i> is % of F.S.
R3	Set point C value	S3 <i>value</i> . where <i>value</i> is % of F.S.
R4	Set point D value	S4 <i>value</i> where <i>value</i> is % of F.S.
R5	System pressure value	P <i>value</i> where <i>value</i> is % of F.S.

Table 27: RS-232 Request and Response Summary
(Continued on next page)

Note



Unless specified otherwise, the *value* in a response is a percent value. For example, a response of S1+30.00 means the set point value is 30% of F.S. For a 10 Torr F. S. unit, the set point would be 3 Torr.

RS-232 Request and Response Summary (Continued)		
Request Message	Information Requested	Response Message
R7	Alternate system status (for compatibility)	<p>WXYZ</p> <p>For the <i>value</i> of X: 0 = analog set point 1 = set point A 2 = set point B 3 = set point C 4 = set point D 5 = set point E</p> <p>For the <i>value</i> of Y: 0 = controlling 2 = valve open 4 = valve close</p> <p>For the <i>value</i> of Z: 0 = pressure \leq 10% F.S. 1 = pressure $>$ 10% F.S.</p>
R10	Set point E value	S5 <i>value</i> where <i>value</i> is % of F.S.
R11	Low threshold process limit #1	P1 <i>value</i> where <i>value</i> is % of F.S.
R12	High threshold process limit #1	P2 <i>value</i> where <i>value</i> is % of F.S.
R13	Low threshold process limit #2	P3 <i>value</i> where <i>value</i> is % of F.S.
R14	High threshold process limit #2	P4 <i>value</i> where <i>value</i> is % of F.S.
R15	Softstart rate for set point A	I1 <i>value</i> where <i>value</i> is % of full speed
R16	Softstart rate for set point B	I2 <i>value</i> where <i>value</i> is % of full speed
R17	Softstart rate for set point C	I3 <i>value</i> where <i>value</i> is % of full speed

Table 27: RS-232 Request and Response Summary
(Continued on next page)

RS-232 Request and Response Summary (Continued)		
Request Message	Information Requested	Response Message
R18	Softstart rate for set point D	I4 <i>value</i> where <i>value</i> is % of full speed
R19	Softstart rate for set point E	I5 <i>value</i> where <i>value</i> is % of full speed
R20	Softstart rate for analog set point	I6 <i>value</i> where <i>value</i> is % of full speed
R21	Softstart rate for valve open	I7 <i>value</i> where <i>value</i> is % of full speed
R22	Softstart rate for valve close	I8 <i>value</i> where <i>value</i> is % of full speed
R23	Valve type	J <i>type</i> , where <i>type</i> equals: 1 = Std 253 2 = Fast 253 3 = 653
R24	Analog set point range	A <i>range</i> , where <i>range</i> equals: 0 = 5 Volts 1 = 10 Volts
R25	Analog set point type(either pressure or position)	T0 <i>type</i> , where <i>type</i> equals: 0 = position 1 = pressure
R26	Set point A type (either pressure or position)	T1 <i>type</i> , where <i>type</i> equals: 0 = position 1 = pressure
R27	Set point B type (either pressure or position)	T2 <i>type</i> , where <i>type</i> equals: 0 = position 1 = pressure
R28	Set point C type (either pressure or position)	T3 <i>type</i> , where <i>type</i> equals: 0 = position 1 = pressure

Table 27: RS-232 Request and Response Summary
(Continued on next page)

RS-232 Request and Response Summary (Continued)		
Request Message	Information Requested	Response Message
R29	Set point D type (either pressure or position)	T4 <i>type</i> , where <i>type</i> equals: 0 = position 1 = pressure
R30	Set point E type (either pressure or position)	T5 <i>type</i> , where <i>type</i> equals: 0 = position 1 = pressure
R31	Position indicator range output	B <i>value</i> , where <i>value</i> equals: 0 = 5 Volts 1 = 10 Volts
R32	Direct/reverse control	N <i>value</i> , where <i>value</i> equals: 0 = direct 1 = reverse
R33	Sensor range	E <i>value</i> , where <i>value</i> equals: 00 = 0.1 10 = 1000 01 = 0.2 11 = 5000 02 = 0.5 12 = 10000 03 = 1 13 = 1.33 04 = 2 14 = 2.66 05 = 5 15 = 13.33 06 = 10 16 = 133.3 07 = 50 17 = 1333 08 = 100 18 = 6666 09 = 500 19 = 13332
R34	Pressure units	F <i>value</i> , where <i>value</i> equals: 00 = Torr 01 = mTorr 02 = mbar 03 = μ bar 04 = kPa 05 = Pa 06 = cmH ₂ O 07 = inH ₂ O

Table 27: RS-232 Request and Response Summary
(Continued on next page)

RS-232 Request and Response Summary (Continued)		
Request Message	Information Requested	Response Message
R35	Sensor voltage range	G <i>value</i> , where <i>value</i> equals: 0 = 1 Volt 1 = 5 Volts 2 = 10 Volts
R36	Sensor type	U <i>value</i> , where <i>value</i> equals: 0 = Absolute 1 = Differential
R37	System status	<p>MXYZ</p> <p>For the <i>value</i> of X: 0 = Local 1 = Remote</p> <p>For the <i>value</i> of Y: 0 = not learning 1 = learning system 2 = learning valve</p> <p>For the <i>value</i> of Z: 0 = open 1 = close 2 = stop 3 = set point A 4 = set point B 5 = set point C 6 = set point D 7 = set point E 8 = Analog set point</p>
R38	Software version	H <i>version number</i>
R39	Status of battery used in optional valve failsafe backup	BT = Battery is bad BT1 = Battery is good BT2 = Option is not installed

Table 27: RS-232 Request and Response Summary
(Continued on next page)

RS-232 Request and Response Summary (Continued)		
Request Message	Information Requested	Response Message
R40	Valve response to power fail (when using the optional valve failsafe backup)	K0 = Option is disabled (or not installed) K1 = Valve opens at power fail K2 = Valve closes at power fail
R41	Lead A value	X1 <i>value</i> where <i>value</i> is seconds
R42	Lead B value	X2 <i>value</i> where <i>value</i> is seconds
R43	Lead C value	X3 <i>value</i> where <i>value</i> is seconds
R44	Lead D value	X4 <i>value</i> where <i>value</i> is seconds
R45	Lead E value	X5 <i>value</i> where <i>value</i> is seconds
R46	Gain A value	M1 <i>value</i> where <i>value</i> is % gain
R47	Gain B value	M2 <i>value</i> where <i>value</i> is % gain
R48	Gain C value	M3 <i>value</i> where <i>value</i> is % gain
R49	Gain D value	M4 <i>value</i> where <i>value</i> is % gain
R50	Gain E value	M5 <i>value</i> where <i>value</i> is % gain
R51	Type of control	V <i>value</i> 0 = Self-Tuning 1 = PID
R52	Checksum error	CS <i>value</i> 0 = OK 1 = Error condition <i>If a checksum error condition is reported perform a full calibration, as described on page 80.</i>

Table 27: RS-232 Request and Response Summary

This page intentionally left blank.

Index

A

Analog set point, 30, 45, 55–57, 58, 76–78, 81

Analog set point inputs, 95

B

Battery backup, 30

Battery-backed memory module, 97–99

C

Calibrating span of A/D converter, 59, 79

Checksum error, 80

Command priority, 29

Control mode

 Self-Tuning or PID, 65

 Valve, 48, 86

Customer support, 19

D

Digital logic control, 90

Digital logic set point, 30

Dipswitch bank, 120–23

Displayless unit, 119–23

E

Electrical information, 24–26

End-of-line delimiter, 61

Environmental requirements, 23

F

Front panel components, 29

Fuse, 24–26

G

Gain parameter, 58, 81

I

Initial settings, 125

Installation Category, 22

Internal switches, 120

Introduction, 17

K

Key Lock switch, 17, 29, 41

L

Lead parameter, 58, 81

Learn analog set point full scale, 77

Learn function, 53, 70

Line voltage setting, 24–26

Local mode, 29

M

Manual organization, 18

Memory module, battery-backed, 97–99

Model code, 115

O

Opening/Closing the unit, 120

- Operating temperature, 23
- Out-of-range signal, 51
- P**
- PID control mode, 29, 41, 65
- PID control parameters, 58, 81
- Pollution Degree, 22
- Position set points, 74
- Pressure set points, 74
- Pressure units, displaying, 43, 44
- Process limit relays, 55, 88
- R**
- Rear panel connectors, 31–38
- Relays, 55, 88
- Remote mode, 29
- Returns, 19
- RS-232 commands, 62, 127–33
- execution priority, 63
- RS-232 communication, 30
- parameters, 42
- RS-232 communications settings, 120–23
- RS-232 message syntax, 61
- RS-232 responses, 63
- S**
- Self-Tuning control mode, 29, 41, 65
- Sensor full scale voltage, 44, 66
- Sensor range, 43, 67
- Sensor type, 66
- Set points, 17, 30, 41, 46, 74
- active, 50, 51, 72, 73
 - adjusting, 50, 73
 - analog, 30, 41, 45, 55–57, 58, 76–78, 81
 - analog inputs, 95
 - digital logic, 30
- Settings, initial, 125
- Setup menu, 65–80
- Softstart control, 30, 41
- Softstart rates, 47
- Specifications, 113–16
- T**
- Temperature, 22
- Trip point relay, 88
- V**
- Valve
- calibration, 40
 - control, 48, 52, 86, 87
 - selection, 40
 - selection and calibration, 64
- Valve position output, 45
- Valve position set point, 58, 74, 81
- Valves supported, 40
- Z**
- Zero
- analog set point, 77
 - how to, 54
 - removing, 54, 69
 - special, 54, 69

MKS Type 651C Pressure Controller

Supplement 1

This supplement contains important information about the valve failsafe battery back-up option for the 651 controller. Specifically, it provides instructions on how to check your controller to ensure that it recognizes when the battery back-up module is present, and how to configure the valve position upon a power loss when using either Local or Remote operation.

Please read the information carefully and make the following additions to your 651C, Revision E instruction manual (MKS p/n 115605-P1).

Please Note:

MKS Instruments provides these documents as the latest version for the revision indicated. The material is subject to change without notice, and should be verified if used in a critical application.

Copyright © 1997 by MKS Instruments, Inc.

All rights reserved. No part of this work may be reproduced or transmitted in any form or by any means, electronic or mechanical, including photocopying and recording, or by any information storage or retrieval system, except as may be expressly permitted in writing by MKS Instruments, Inc.

This manual is for firmware/software version 1.8x.

Introduction

The optional valve failsafe battery back-up provides full valve drive capability for approximately 30 seconds after an AC power failure.

This supplement provides instructions on how to check your controller to ensure that it recognizes when the battery back-up module is present, and how to configure the valve position upon a power loss when using either Local or Remote operation.

Note

For complete, detailed information on the battery back-up option, refer to *Chapter Eight: Valve Failsafe Battery Back-up Option*, in Revision E of the 651C instruction manual.

Battery Voltage

The normal voltage level of the battery ranges from 11 V to 15.5 V. A voltage level *below* 11 V indicates a discharged battery. A voltage level *above* 15.5 V indicates an open fuse, a disconnected battery, or a defective charger.

Valve Positions

The controller can be configured so that the valve will be driven fully open, fully closed, or will be disabled upon an AC power failure.

Open: The controller opens the valve at power down. In the event that the valve is already open, the module provides power for approximately 1 second before turning off.

Closed: The controller closes the valve at power down. In the event that the valve is already closed, the module provides power for approximately 1 second before turning off.

Disable: The option is disabled and will not perform any function at power down. The controller turns off in a normal manner.

When the controller is configured to open or close the valve, it will perform the operation whenever power to the controller is turned off, regardless of whether the power is turned off via the power switch or by a power failure.

Note

If for any reason the controller cannot open or close the valve within 30 seconds of a power failure, the battery back-up module automatically turns off. This prevents the battery from discharging when no valve is present or if the valve is defective in some way.

Startup

Threshold Voltage Check

When the 651 controller is turned on, it measures the voltage at the input port assigned to the battery back-up module. When the voltage level at the port exceeds a factory set minimum threshold value, the controller recognizes that the battery back-up is present, and the software menus which support the module are installed. Should the voltage level be below the threshold, the controller does not recognize the module and the software menus are not installed.

Once the 651 unit has been powered up and the battery back-up module has been recognized, the actual voltage of the battery is measured.

Battery Voltage Within Range

If the battery voltage is within the acceptable range of 11 V to 15.5 V, the instrument revision and the current software/firmware version appears on the front panel display for about five seconds, before advancing to the default *Pressure and Position* screen:

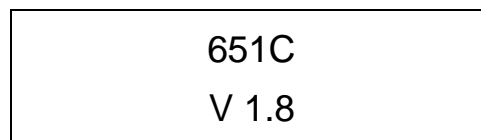

Figure 1: Initial Display Screen

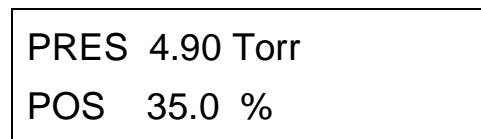

Figure 2: Default Pressure and Position Screen

The controller is now ready for valve connection and setup (or normal operation once the system has been configured). The 651 unit does not display a status screen to indicate that the battery voltage is within range.

Battery Voltage Out-of-Range

If the battery voltage is out-of-range, the instrument revision and the current software/firmware version appears on the front panel display for about five seconds (refer to Figure 1, page 4), followed by the appropriate error message, rather than advancing to the default *Pressure and Position* display screen (refer to Figure 2, page 4).

If the battery voltage is below 11 V, the screen displays:

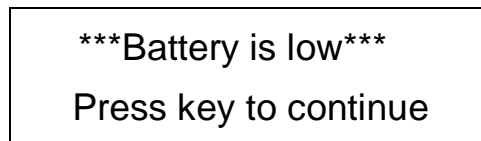

Figure 3: Battery Voltage Low Message

If the battery voltage is above 15.5 V, the screen displays:

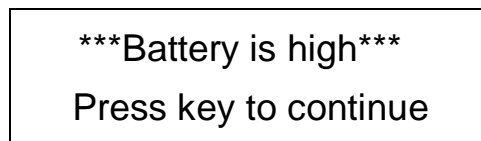

Figure 4: Battery Voltage High Message

The system allows for continued operation when the battery voltage is out-of-range, since your process may not require that the battery voltage level be addressed immediately. To continue operation, press any key to advance to the default *Pressure and Position* display screen.

Note

It is important to note that in addition to supporting the controller's valve position, the battery back-up feature powers the controller, and any pressure transducer or valve connected to it.

Operation

How To Check the Battery Voltage

To ensure that the 651 unit has recognized the battery back-up module, or to view the actual battery voltage and the current valve configuration without entering the software menus (regardless of whether you are using Local or Remote operation):

1. Ensure that the default *Pressure and Position* screen appears on the display:

PRES	4.90 Torr
POS	35.0 %

2. Press the [▽] key one time.

If the battery back-up module has been recognized, the screen displays:

BATTERY	13.5V
BACK-UP:	OPEN

This screen allows you to view the actual battery voltage and the current valve configuration. The valve configuration cannot be changed from this screen. Refer to *How To Set The Battery Back-up Valve Control*, page 7, for instructions on how to change the valve configuration; the battery voltage cannot be adjusted. Press any key to return to the default *Pressure and Position* screen.

If the battery back-up module has *not* been recognized, the screen reverts to the initial display screen which lists the instrument revision and the current software/firmware version:

651C
V 1.8



Press any key to return to the default *Pressure and Position* screen.

How To Set The Battery Back-up Valve Control

Local Operation



1. Ensure the Key Lock Switch is set to Local and that the default *Pressure and Position* display appears on the screen.

PRES	4.90 Torr
POS	35.0 %

2. Press the [] and [] keys simultaneously for about 3 seconds to enter the Setup menu.

The screen displays:

CONTROL	
MODE:	PID

2. Press the [] or [] down arrow key to scroll through the menu until the battery back-up option selection screen appears on the display.

The screen displays:

BATTERY	13.5V
BACK-UP:	OPEN

The screen displays the actual voltage level of the battery along with the position the valve is currently set to drive to upon a power loss.

Select whether the valve will be driven fully open, fully closed, or will be disabled upon an AC power failure by turning the Adjust knob on the front panel to the desired setting. Choose from the options of open, closed, or disable (initial).

Note

Press any key to exit the Setup menu and return to the default *Pressure and Position* display screen.

Remote RS-232 Operation

The command [**K** *value*] defines the direction of valve control upon power failure, where:

value: 0 = disable option
1 = open valve at power failure
2 = close valve at power failure

To check the type of valve battery back-up control, issue the request:

R 40

The controller responds with the message [**K** *value*], where:

value: 0 = option disabled
1 = valve opens at power failure
2 = valve closes at power failure

An example response, if the valve is set to open upon a power failure, is:

K 1

To change the valve control so that it closes upon a power failure, enter:

K 2

MKS Type 651C and 655A Pressure Controllers

Firmware Revision Kit FRK-651C-V1.9 FRK-655A-V1.9

Please Note:

MKS Instruments provides these documents as the latest version for the revision indicated. The material is subject to change without notice, and should be verified if used in a critical application.

Copyright © 1998 by MKS Instruments, Inc.

All rights reserved. No part of this work may be reproduced or transmitted in any form or by any means, electronic or mechanical, including photocopying and recording, or by any information storage or retrieval system, except as may be expressly permitted in writing by MKS Instruments, Inc.

Baratron® is a registered trademark of MKS Instruments, Inc., Andover, MA

Firmware version: 1.9x

General Information

Unpacking Checklist

This Firmware Revision Kit comes with the following items:

- FIRMWARE EPROM (U6) - Rev. 1.9x
 - For units *with* a display:** MKS part no. 114547-P1
 - For units *without* a display:** MKS part no. 114547-P2
- Instructions on how to upgrade to EPROM version 1.9x
(this document, MKS part no. 122094-P1)

Downward Compatibility

The 651C and 655A version 1.9x firmware is completely compatible with the 651C and 655A version 1.8x firmware.

Returning the Type 651/655 Unit for Firmware Revision

Standard maintenance services are available at all of our regional MKS Calibration and Service Centers listed on the inside back cover of your instruction manual. Should you prefer to have MKS upgrade your Type 651/655 instrument, contact any authorized MKS Service Center.

Before shipping the instrument to MKS, please obtain an ERA Number (Equipment Return Authorization Number) from the MKS Service Center. The ERA Number expedites handling and assures proper servicing of your instrument. Please refer to the inside of the back cover of your instruction manual for a list of MKS Calibration and Service Centers.

Warning

All returns to MKS Instruments must be free of harmful, corrosive, radioactive, or toxic materials.

This page intentionally left blank.

Safety Information

The following general safety precautions must be observed during all phases of upgrading this instrument. MKS Instruments, Inc. assumes no liability for the customer's failure to comply with these requirements.

DO NOT SUBSTITUTE PARTS OR MODIFY INSTRUMENT

Do not install substitute parts or perform any unauthorized modification to the instrument.

SERVICE BY QUALIFIED PERSONNEL ONLY

Operating personnel must not remove instrument covers. Component replacement and internal adjustments must be made by qualified service personnel only.

KEEP AWAY FROM LIVE CIRCUITS

Lethal voltages are present in the instrument when the power cord is connected. Do not replace components with power cable connected. To avoid injuries, always disconnect power cord and discharge circuits before touching them.

This page intentionally left blank.

EPROM Replacement Instructions

How To Open the Unit

Warning



DISCONNECT THE POWER CORD

The 651/655 unit has lethal voltages present when the power cord is connected. To avoid the danger of electrical shock, disconnect the power cord before opening the unit.

1. Turn the power off.
2. Disconnect the AC power cord.

Caution



To avoid damage to sensitive internal components, personnel should be grounded through a safety impedance while working inside the 651/655 unit, and the unit itself must be static-free.

3. Remove the two Phillips screws located at the top of the rear panel.
4. Disengage the cover from the rear chassis by lifting it up from the clips.
5. Remove the top cover by firmly pulling it up and back to clear the top of the connector plates.

How To Remove the CPU Board

1. Locate the CPU board.

It is labeled on the rear panel as the Serial Interface connector (1) and is adjacent to the power supply.

2. Remove the screw to the left of the CPU connector.

It may be necessary to remove the clamping spring that holds the card cage to the power supply. If so, use needle-nose pliers or a screwdriver to pull the clamping spring straight back and out.

3. Grasp each end of the board and rock it until it loosens. Lift the board up and out of the unit.

How To Replace the EPROM

1. Locate the EPROM.

The EPROM is located in the middle of the CPU board, when viewed from the top.

2. Firmly grasp the EPROM and disengage it from the socket.
3. Position the new EPROM so that the notch matches the notch marked on the CPU board and on the socket, and firmly seat the EPROM in the socket.

How To Replace the CPU Board

1. Position the CPU board over its slot in the unit, ensuring that the board's edge is behind the next connector's edge. Push on the bottom tab to snap the board into the slot.

2. Use any grounded instrument to gently seat the clamping spring firmly in place.

A metal tab prevents the spring from sliding in completely. To remove the board the next time, insert a small screwdriver into the space left by the tab.

How To Replace the Cover

1. Slide the cover (from rear to front) into place at the front panel.

2. Position the cover so that the cover slots engage the top of the connector plates.

From the front (looking at the top of the unit toward the rear), pull the cover toward the front while alternately tightening the screws. This ensures a good electrical connection between the top cover and the rear connector plates.

3. Reconnect the AC power cord and turn the power on.

Note

You must reset all configuration settings and repeat the learn process after replacement of the EPROM.
