



116752-P1
Rev C, 3/99
Instruction Manual

MKS Type 153E Throttle Valve Controller



WARRANTY

Type 153E Equipment

MKS Instruments, Inc. (**MKS**) warrants that the equipment described above (the "equipment") manufactured by **MKS** shall be free from defects in materials and workmanship for a period of one year from date of shipment and will for a period of two years from the date of shipment, correctly perform all date-related operations, including without limitation accepting data entry, sequencing, sorting, comparing, and reporting, regardless of the date the operation is performed or the date involved in the operation, provided that, if the equipment exchanges data or is otherwise used with equipment, software, or other products of others, such products of others themselves correctly perform all date-related operations and store and transmit dates and date-related data in a format compatible with **MKS** equipment. THIS WARRANTY IS **MKS'** SOLE WARRANTY CONCERNING DATE-RELATED OPERATIONS.

For the period commencing with the date of shipment of this equipment and ending one year later in the case of defects in materials and workmanship, but two years later in the case of failure to comply with the date-related operations warranty, **MKS** will, at its option, either repair or replace any part which is defective in materials or workmanship or with respect to the date-related operations warranty without charge to the purchaser. The foregoing shall constitute the exclusive and sole remedy of the purchaser for any breach by **MKS** of this warranty.

The purchaser, before returning any equipment covered by this warranty, which is asserted to be defective by the purchaser, shall make specific written arrangements with respect to the responsibility for shipping the equipment and handling any other incidental charges with the **MKS** sales representative or distributor from which the equipment was purchased or, in the case of a direct purchase from **MKS**, with the **MKS** home office in Andover, Massachusetts, USA.

This warranty does not apply to any equipment which has not been installed and used in accordance with the specifications recommended by **MKS** for the proper and normal use of the equipment. **MKS** shall not be liable under any circumstances for indirect, special, consequential, or incidental damages in connection with, or arising out of, the sale, performance, or use of the equipment covered by this warranty.

MKS recommends that all **MKS** pressure and flow products be calibrated periodically (typically every 6 to 12 months) to ensure accurate readings. When a product is returned to **MKS** for this periodic re-calibration it is considered normal preventative maintenance not covered by any warranty.

THIS WARRANTY IS IN LIEU OF ALL OTHER RELEVANT WARRANTIES, EXPRESSED OR IMPLIED, INCLUDING THE IMPLIED WARRANTY OF MERCHANTABILITY AND THE IMPLIED WARRANTY OF FITNESS FOR A PARTICULAR PURPOSE, AND ANY WARRANTY AGAINST INFRINGEMENT OF ANY PATENT.

MKS Type 153E Throttle Valve Controller

Please Note:

MKS Instruments provides these documents as the latest version for the revision indicated. The material is subject to change without notice, and should be verified if used in a critical application.

Copyright © 1999 by MKS Instruments, Inc.

All rights reserved. No part of this work may be reproduced or transmitted in any form or by any means, electronic or mechanical, including photocopying and recording, or by any information storage or retrieval system, except as may be expressly permitted in writing by MKS Instruments, Inc.

Printed in the United States of America

Cluster Gauge™ is trademark of MKS Instruments, Inc., Andover, MA

Parker® is a registered trademark of Parker Seals, Lexington, KY

Viton® is a registered trademark of DuPont Dow Elastomers, Inc., Wilmington, DE

Firmware version: 1.1x

Table of Contents

Valve Safety Information	1
Symbols Used in This Instruction Manual.....	1
Symbols Found on the Unit	2
Safety Procedures and Precautions	3
Sicherheitshinweise für das Ventil.....	5
In dieser Betriebsanleitung vorkommende Symbole	5
Erklärung der am Gerät angebrachten Symbole	6
Sicherheitsvorschriften und Vorsichtsmaßnahmen.....	7
Informations relatives à la sécurité pour la valve.....	9
Symboles utilisés dans ce manuel d'utilisation	9
Symboles apparaissant sur l'unité.....	10
Mesures de sécurité et précautions	11
Medidas de seguridad de la válvula	13
Símbolos usados en este manual de instrucciones.....	13
Símbolos hallados en la unidad	14
Procedimientos y precauciones de seguridad	15
Chapter One: General Information.....	17
Introduction	17
How This Manual is Organized.....	18
Customer Support.....	18
Chapter Two: Installation.....	19
How To Unpack the Type 153 Unit	19
Unpacking Checklist	19
Interface Cables	20
Generic Shielded Cables.....	21
Setup	23
Dimensions	23
O-Ring Material	28

Power Requirements	28
Grounding	28
Mounting Instructions.....	30
Connectors	32
Power Connector (J2)	32
Input Connector (J1)	33
How To Connect to a PT-1 Portable RS-232 Terminal	36
How To Connect to a Computer	37
How To Connect to a Type 146 Cluster Gauge™	38
Chapter Three: Overview	39
Control Mode.....	39
Lead and Gain.....	39
External Connectors and Controls	42
Power On LED	42
Input Connector (J1)	42
Power Connector (J2)	42
Hold/Normal Switch.....	43
Manual Valve Switch.....	43
Valve Open LED	43
Valve Close LED.....	43
Internal Controls	44
Dipswitch Bank	44
How To Change the Dipswitch Settings.....	47
Power-Down Constants	48
Power Up Conditions	48
Labels	49
Pump Label	49
Serial Number Label.....	49
Chapter Four: Operation	51
General Information	51
Control Parameters.....	51
RS-232 Communication Parameters	52

How To Change the Communication Parameters	53
RS-232 Protocol	54
Message Format	54
Message Syntax.....	55
RS-232 Communication Commands	56
Operating Value Messages	57
How To Set the Lead and Gain.....	58
How To Set the Set Point	58
Valve Position Messages	59
How To Control the Valve	60
How To Set the Valve Position.....	60
How To Return to Normal Operation.....	61
Calibration Messages	62
How To Learn the System Characteristics	62
How To Calibrate the System for Output Errors	68
Informational Messages	72
How To Report the Pressure Reading	72
How To Report the Analog Set Point Input Voltage	73
How To Report the Status of the Valve Slipped Signal	73
How To Use the Pressure Control Mode	74
How To Select the Pressure Control Mode	74
How To Use an Analog Set Point for Pressure Control	74
How To Use a Digital Set Point for Pressure Control	75
How To Override the Pressure Control Mode	75
How To Use the Position Control Mode	76
How To Select the Position Control Mode.....	76
How To Use an Analog Set Point for Position Control	76
How To Use a Digital Set Point for Position Control.....	77
How To Tune the Controller	78
How To Reset the Controller	80
Chapter Five: Maintenance and Troubleshooting	83
General Information.....	83
Maintenance	83

How To Clean the Unit.....	83
Troubleshooting	84
Valve Slipped Signal	84
Appendix A: Product Specifications.....	85
Valve Specifications.....	85
ASA Flange Specifications.....	87
KF Style ISO Flange Specifications	89
NW Style ISO Flange Specifications	91
CF Flange Specifications.....	92
JIS Flange Specifications.....	94
Appendix B: Model Code Explanation.....	95
Model Code	95
Type 153 Controller Model Codes.....	97
Type 153 Units with ASA Flanges.....	97
Type 153 Controller with KF or NW ISO Flanges	98
Type 153 Controller with CF Flanges	99
Type 153 Controller with JIS Flanges	100
Portable RS-232 Terminal Model Code.....	100
Index	101

List of Figures

Figure 1: Preferred Method To Connect an Overall Metal Braided Shielded Cable	22
Figure 2: Alternate Method To Connect an Overall Metal Braided Shielded Cable	22
Figure 3: Type 153 Controller Dimensions	23
Figure 4: Outline Dimensions of an ASA Flange	24
Figure 5: Outline Dimensions of a KF Style ISO Flange	25
Figure 6: Outline Dimensions of a NW Style ISO Flange	26
Figure 7: Outline Dimensions of a CF Flange	26
Figure 8: Outline Dimensions of a JIS Flange	27
Figure 9: Returned Leads Tied to System Ground	29
Figure 10: Typical System Configuration	31
Figure 11: Null Modem RS-232 Communication Cable	37
Figure 12: Lead Set Too High	40
Figure 13: Lead Set Too Low	40
Figure 14: Gain Set Too High	41
Figure 15: Gain Set Too Low	41
Figure 16: Top Panel of the 153 Controller	42
Figure 17: Location of the Dipswitch Bank on the CPU Board	44
Figure 18: Pump Label	49
Figure 19: Serial Number Label	49

List of Tables

Table 1: Definition of Symbols Found on the Unit	2
Tabelle 2: Bedeutung der am Gerät angebrachten Symbole.....	6
Tableau 3: Définition des symboles apparaissant sur l'unité.....	10
Tabla 4: Definición de los símbolos hallados en la unidad.....	14
Table 5: Interface Cables	20
Table 6: Power Connector (J2) Pinout	32
Table 7: Input Connector (J1) Pinout.....	33
Table 8: Example Pressure Outputs for Input Connector Pin 4.....	35
Table 9: Example Valve Position Outputs for Input Connector Pin 6.....	35
Table 10: Dipswitch Functions and Settings	45
Table 11: Initial Control Parameters	51
Table 12: Initial RS-232 Communication Parameters	52
Table 13: RS-232 Operating Value Messages	57
Table 14: RS-232 Valve Position Messages.....	59
Table 15: RS-232 Learn Messages.....	62
Table 16: RS-232 Calibration for Output Error Messages	68
Table 17: RS-232 Informational Messages	72
Table 18: Settings Established by the Reset [B] Command.....	80
Table 19: Model Codes for Type 153 Units with ASA Flanges.....	97
Table 20: Model Codes for Type 153 Units with KF or NW ISO Flanges.....	98
Table 21: Model Codes for Type 153 Units with CF Flanges.....	99
Table 22: Model Codes for Type 153 Units with CF Flanges.....	100

Valve Safety Information

Symbols Used in This Instruction Manual

Definitions of WARNING, CAUTION, and NOTE messages used throughout the manual.

Warning

The **WARNING** sign denotes a hazard to personnel. It calls attention to a procedure, practice, condition, or the like, which, if not correctly performed or adhered to, could result in injury to personnel.

Caution

The **CAUTION** sign denotes a hazard to equipment. It calls attention to an operating procedure, practice, or the like, which, if not correctly performed or adhered to, could result in damage to or destruction of all or part of the product.

Note

The **NOTE** sign denotes important information. It calls attention to a procedure, practice, condition, or the like, which is essential to highlight.

Symbols Found on the Unit

The following table describes symbols that may be found on the unit.















Definition of Symbols Found on the Unit			
			
On (Supply) IEC 417, No.5007	Off (Supply) IEC 417, No.5008	Earth (ground) IEC 417, No.5017	Protective earth (ground) IEC 417, No.5019
			
Frame or chassis IEC 417, No.5020	Equipotentiality IEC 417, No.5021	Direct current IEC 417, No.5031	Alternating current IEC 417, No.5032
			
Both direct and alternating current IEC 417, No.5033-a	Class II equipment IEC 417, No.5172-a	Three phase alternating current IEC 617-2 No.020206	
			
Caution, refer to accompanying documents ISO 3864, No.B.3.1	Caution, risk of electric shock ISO 3864, No.B.3.6	Caution, hot surface IEC 417, No.5041	

Table 1: Definition of Symbols Found on the Unit

Safety Procedures and Precautions

Observe the following general safety precautions during all phases of valve operation. Failure to comply with these precautions or with specific warnings elsewhere in this manual violates safety standards of intended use of the valve and may impair the protection provided by the equipment. MKS Instruments, Inc. assumes no liability for the customer's failure to comply with these requirements.

Warning



Moving parts in the valve create a risk of personal injury until the valve is securely incorporated into a system. To avoid injury, keep all bodily parts away from any valve opening.

- 1. Do not insert objects into openings where contact with moving parts is possible.**
 - 2. Isolate the valve from any electrical or pneumatic power supply before handling the valve.**
-

DO NOT SUBSTITUTE PARTS OR MODIFY VALVE

Do not install substitute parts or perform any unauthorized modification to the valve. Return the valve to an MKS Calibration and Service Center for service and repair to ensure that all safety features are maintained.

SERVICE BY QUALIFIED PERSONNEL ONLY

Operating personnel must not attempt component replacement and internal adjustments. Any service must be performed by qualified service personnel only.

USE CAUTION WHEN OPERATING WITH HAZARDOUS MATERIALS

If hazardous materials are used, observe the proper safety precautions, completely purge the valve when necessary, and ensure that the material used is compatible with the wetted materials in this product, including any sealing materials.

PURGE THE VALVE

After installing the unit, or before removing it from a system, purge the unit completely with a clean, dry gas to eliminate all traces of the previously used flow material.

USE PROPER PROCEDURES WHEN PURGING

This valve must be purged under a ventilation hood, and gloves must be worn for protection.

DO NOT OPERATE IN AN EXPLOSIVE ENVIRONMENT

To avoid explosion, do not operate this product in an explosive environment unless it has been specifically certified for such operation.

USE PROPER FITTINGS AND TIGHTENING PROCEDURES

All valve fittings must be consistent with valve specifications, and compatible with the intended use of the valve. Assemble and tighten fittings according to manufacturer's directions.

CHECK FOR LEAK-TIGHT FITTINGS

Carefully check all vacuum component connections to ensure leak-tight installation.

OPERATE AT SAFE INLET PRESSURES

Never operate the valve at pressures higher than the rated maximum pressure (refer to the product specifications for the maximum allowable pressure).

INSTALL A SUITABLE BURST DISC

When operating from a pressurized gas source, install a suitable burst disc in the vacuum system to prevent system explosion should the system pressure rise.

KEEP THE UNIT FREE OF CONTAMINANTS

Do not allow contaminants to enter the unit before or during use. Contamination such as dust, dirt, lint, glass chips, and metal chips may permanently damage the unit or contaminate the process.

KEEP AWAY FROM VALVE OPENING

Keep fingers, other body parts, and other materials away from the valve opening when the valve is in operation.

Sicherheitshinweise für das Ventil

In dieser Betriebsanleitung vorkommende Symbole

Bedeutung der mit WARNUNG!, VORSICHT! und HINWEIS gekennzeichneten Absätze in dieser Betriebsanleitung.

Warnung!



Das Symbol **WARNUNG!** weist auf eine Gefahr für das Bedienpersonal hin. Es macht auf einen Arbeitsablauf, eine Arbeitsweise, einen Zustand oder eine sonstige Gegebenheit aufmerksam, deren unsachgemäße Ausführung bzw. ungenügende Berücksichtigung zu Verletzungen führen kann.

Vorsicht!



Das Symbol **VORSICHT!** weist auf eine Gefahr für das Gerät hin. Es macht auf einen Bedienungsablauf, eine Arbeitsweise oder eine sonstige Gegebenheit aufmerksam, deren unsachgemäße Ausführung bzw. ungenügende Berücksichtigung zu einer Beschädigung oder Zerstörung des Gerätes oder von Teilen des Gerätes führen kann.

Hinweis



Das Symbol **HINWEIS** macht auf wichtige Informationen bezüglich eines Arbeitsablaufs, einer Arbeitsweise, eines Zustands oder einer sonstige Gegebenheit aufmerksam.

Erklärung der am Gerät angebrachten Symbole

Nachstehender Tabelle sind die Bedeutungen der Symbole zu entnehmen, die am Gerät angebracht sein können.















Bedeutung der am Gerät angebrachten Symbole			
			
Ein (Energie) IEC 417, No.5007	Aus (Energie) IEC 417, No.5008	Erdanschluß IEC 417, No.5017	Schutzleiteranschluß IEC 417, No.5019
			
Masseanschluß IEC 417, No.5020	Equipotential- anschluß IEC 417, No.5021	Gleichstrom IEC 417, No.5031	Wechselstrom IEC 417, No.5032
			
Gleich- oder Wechselstrom IEC 417, No.5033-a	Durchgängige doppelte oder verstärkte Isolierung IEC 417, No.5172-a	Dreileiter- Wechselstrom (Drehstrom) IEC 617-2, No.020206	
			
Warnung vor einer Gefahrenstelle (Achtung, Dokumen- tation beachten) ISO 3864, No.B.3.1	Warnung vor gefährlicher elektrischer Spannung ISO 3864, No.B.3.6	Höhere Temperatur an leicht zugänglichen Teilen IEC 417, No.5041	

Tabelle 2: Bedeutung der am Gerät angebrachten Symbole

Sicherheitsvorschriften und Vorsichtsmaßnahmen

Folgende allgemeine Sicherheitsvorschriften sind während allen Betriebsphasen dieses Ventils zu befolgen. Eine Mißachtung der Sicherheitsvorschriften und sonstiger Warnhinweise in dieser Betriebsanleitung verletzt die für dieses Ventil und seine Bedienung geltenden Sicherheitsstandards, und kann die eingebauten Schutzvorrichtungen wirkungslos machen. MKS Instruments, Inc. haftet nicht für Mißachtung dieser Sicherheitsvorschriften seitens des Kunden.

Warnung!



Solange das Ventil nicht fest in ein System eingebaut ist, besteht Verletzungsgefahr aufgrund von beweglichen Teilen. Daher Finger und andere Körperteile unbedingt von allen Ventilöffnungen fernhalten.

- 1. Niemals Fremdkörper in Öffnungen einführen, in denen ein Kontakt mit beweglichen Teilen möglich ist.**
 - 2. Das Ventil vor dem Hantieren stets von allen elektrischen und pneumatischen Kraftquellen trennen.**
-

Niemals Teile austauschen oder Änderungen am Ventil vornehmen!

Ersetzen Sie keine Teile mit baugleichen oder ähnlichen Teilen, und nehmen Sie keine eigenmächtigen Änderungen am Ventil vor. Schicken Sie das Ventil zwecks Wartung und Reparatur an den MKS-Kalibrierungs- und -Kundendienst ein. Nur so wird sichergestellt, daß alle Schutzvorrichtungen voll funktionsfähig bleiben.

Wartung nur durch qualifizierte Fachleute!

Das Auswechseln von Komponenten und das Vornehmen von internen Einstellungen darf nur von qualifizierten Fachleuten durchgeführt werden, niemals vom Bedienpersonal.

Vorsicht beim Arbeiten mit gefährlichen Stoffen!

Wenn gefährliche Stoffe verwendet werden, muß der Bediener die entsprechenden Sicherheitsvorschriften genauestens einhalten, das Ventil, falls erforderlich, vollständig spülen, sowie sicherstellen, daß der Gefahrstoff die von ihm benetzten, im Ventil verwendeten Materialien, insbesondere Dichtungen, nicht angreift.

Spülen des Ventils mit Gas!

Nach dem Installieren oder vor dem Ausbau aus einem System muß das Ventil unter Einsatz eines reinen Trockengases vollständig gespült werden, um alle Rückstände des Vorgängermediums zu entfernen.

Anweisungen zum Spülen des Ventils!

Das Ventil darf nur unter einer Ablufthaube gespült werden. Schutzhandschuhe sind zu tragen.

Nicht zusammen mit explosiven Stoffen, Gasen oder Dämpfen benutzen!

Um der Gefahr einer Explosion vorzubeugen, darf dieses Produkt niemals zusammen mit explosiven Stoffe aller Art eingesetzt werden, sofern es nicht ausdrücklich für diesen Zweck zugelassen ist.

Anweisungen zum Installieren der Armaturen!

Alle Ventilanschlußstücke und Armaturenteile müssen mit den Ventilspezifikationen übereinstimmen, und mit dem geplanten Einsatz des Ventils kompatibel sein. Der Einbau, insbesondere das Anziehen und Abdichten, muß gemäß den Anweisungen des Herstellers vorgenommen werden.

Ventil auf Undichtigkeiten prüfen!

Überprüfen Sie sorgfältig alle Verbindungen auf undichte Stellen.

Nur unter zulässigen Anschlußdrücken betreiben!

Betreiben Sie das Ventil niemals unter Drücken, die den maximal zulässigen Druck (siehe Produktspezifikationen) übersteigen.

Geeignete Berstscheibe installieren!

Wenn mit einer unter Druck stehenden Gasquelle gearbeitet wird, sollte eine geeignete Berstscheibe in das Vakuumsystem installiert werden, um eine Explosionsgefahr aufgrund von steigendem Systemdruck zu vermeiden.

Verunreinigungen vermeiden!

Stellen Sie sicher, daß Verunreinigungen jeglicher Art weder vor dem Einsatz noch während des Betriebs in das Innere gelangen können. Staub- und Schmutzpartikel, Glassplitter oder Metallspäne können das Produkt dauerhaft beschädigen oder Prozeß und Meßwerte verfälschen.

Hände weg von der Ventilöffnung!

Körperteile, insbesondere Finger, sowie Fremdobjekte während des Betriebes von der Ventilöffnung fernhalten.

Informations relatives à la sécurité pour la valve

Symboles utilisés dans ce manuel d'utilisation

Définitions des indications AVERTISSEMENT, ATTENTION, et REMARQUE utilisées dans ce manuel.

Avertissement



L'indication **AVERTISSEMENT** signale un danger pour le personnel. Elle attire l'attention sur une procédure, une pratique, une condition, ou toute autre situation présentant un risque d'accident pour le personnel, en cas d'exécution incorrecte ou de non respect des consignes.

Attention



L'indication **ATTENTION** signale un danger pour l'appareil. Elle attire l'attention sur une procédure d'exploitation, une pratique, ou toute autre situation, présentant un risque d'endommagement ou de destruction d'une partie ou de la totalité de l'appareil, en cas d'exécution incorrecte ou de non respect des consignes.

Remarque



L'indication **REMARQUE** signale une information importante. Elle attire l'attention sur une procédure, une pratique, une condition, ou toute autre situation, présentant un intérêt particulier.

Symboles apparaissant sur l'unité

Le tableau suivant décrit les symboles pouvant apparaître sur l'unité.















Définition des symboles apparaissant sur l'unité			
			
Marche (sous tension) IEC 417, No.5007	Arrêt (hors tension) IEC 417, No.5008	Terre (masse) IEC 417, No.5017	Terre de protection (masse) IEC 417, No.5019
			
Masse IEC 417, No.5020	Equipotentialité IEC 417, No.5021	Courant continu IEC 417, No.5031	Courant alternatif IEC 417, No.5032
			
Courant continu et alternatif IEC 417, No.5033-a	Matériel de classe II IEC 417, No.5172-a	Courant alternatif triphase IEC 617-2, No.020206	
			
Attention : se reporter à la documentation ISO 3864, No.B.3.1	Attention : risque de choc électrique ISO 3864, No.B.3.6	Attention : surface brûlante IEC 417, No.5041	

Tableau 3: Définition des symboles apparaissant sur l'unité

Mesures de sécurité et précautions

Prendre les précautions générales de sécurité suivantes pendant toutes les phases d'exploitation de la valve. Le non respect des ces précautions ou des avertissements contenus dans ce manuel constitue une violation des normes de sécurité relatives à l'utilisation de la valve et peut diminuer la protection fournie par l'appareil. MKS Instruments, Inc. n'assume aucune responsabilité concernant le non respect des consignes par les clients.

Avertissement



Les pièces mobiles de la valve peuvent être une cause d'accident tant que la valve n'est pas solidement incorporée dans un système. Pour éviter tout accident, tenir toute partie du corps à distance de toute ouverture de la valve.

- 1. Ne pas insérer des objets dans les ouvertures où le contact avec des pièces mobiles est possible.**
 - 2. Isoler la valve de toute source d'alimentation électrique ou pneumatique pendant la manipulation de la valve.**
-

PAS DE SUBSTITUTION DE PIÈCES OU DE MODIFICATION DE LA VALVE

Ne pas installer des pièces de substitution ou effectuer des modifications non autorisées sur la valve. Renvoyer la valve à un centre de service et de calibrage MKS pour tout dépannage ou réparation afin de garantir le l'intégrité des dispositifs de sécurité.

DÉPANNAGE UNIQUEMENT PAR DU PERSONNEL QUALIFIÉ

Le personnel d'exploitation ne doit pas essayer de remplacer des composants ou de faire des réglages internes. Tout dépannage doit être uniquement effectué par du personnel qualifié.

PRÉCAUTION EN CAS D'UTILISATION AVEC DES PRODUITS DANGEREUX

Si des produits dangereux sont utilisés, prendre les mesures de précaution appropriées, purger complètement la valve quand cela est nécessaire, et s'assurer que les produits utilisés sont compatibles avec les composants liquides de l'appareil, y compris les matériaux d'étanchéité.

PURGE DE LA VALVE

Après l'installation de l'unité, ou avant son enlèvement d'un système, purger l'unité complètement avec un gaz propre et sec afin d'éliminer toute trace du produit de flux utilisé précédemment.

UTILISATION DES PROCÉDURES APPROPRIÉES POUR LA PURGE

Cette valve doit être purgée sous une hotte de ventilation, et il faut porter des gants de protection.

PAS D'EXPLOITATION DANS UN ENVIRONNEMENT EXPLOSIF

Pour éviter toute explosion, ne pas utiliser cet appareil dans un environnement explosif, sauf en cas d'homologation spécifique pour une telle exploitation.

UTILISATION D'ÉQUIPEMENTS APPROPRIÉS ET PROCÉDURES DE SERRAGE

Tous les équipements de la valve doivent être cohérents avec ses spécifications, et compatibles avec l'utilisation prévue de la valve. Assembler et serrer les équipements conformément aux directives du fabricant.

VÉRIFICATION DE L'ÉTANCHÉITÉ DES CONNEXIONS

Vérifier attentivement toutes les connexions des composants pour le vide afin de garantir l'étanchéité de l'installation.

EXPLOITATION AVEC DES PRESSIONS D'ENTRÉE NON DANGEREUSES

Ne jamais utiliser la valve avec des pressions supérieures à la pression nominale maximum (se reporter aux spécifications de l'unité pour la pression maximum admissible).

INSTALLATION D'UN DISQUE D'ÉCHAPPEMENT ADAPTÉ

En cas d'exploitation avec une source de gaz pressurisé, installer un disque d'échappement adapté dans le système à vide afin d'éviter une explosion du système en cas d'augmentation de la pression.

MAINTIEN DE L'UNITÉ À L'ABRI DES CONTAMINATIONS

Ne pas laisser des produits contaminants pénétrer dans l'unité avant ou pendant l'utilisation. Des produits contaminants tels que des poussières et des fragments de tissu, de glace et de métal peuvent endommager l'unité d'une manière permanente ou contaminer le processus.

PRÉCAUTION AVEC L'OUVERTURE DE LA VALVE

Éviter tout contact des mains, toute autre partie du corps, ou tout autre matériel avec l'ouverture de la valve quand celle-ci est en fonctionnement.

Medidas de seguridad de la válvula

Símbolos usados en este manual de instrucciones

Definiciones de los mensajes de advertencia, precaución y de las notas usados en el manual.

Advertencia



El símbolo de advertencia indica la posibilidad de que se produzcan daños personales. Pone de relieve un procedimiento, práctica, estado, etc. que en caso de no realizarse u observarse correctamente puede causar daños personales.

Precaución



El símbolo de precaución indica la posibilidad de producir daños al equipo. Pone de relieve un procedimiento operativo, práctica, estado, etc. que en caso de no realizarse u observarse correctamente puede causar daños o la destrucción total o parcial del equipo.

Nota



El símbolo de notas indica información de importancia. Este símbolo pone de relieve un procedimiento, práctica o condición cuyo conocimiento es esencial destacar.

Símbolos hallados en la unidad

La tabla siguiente contiene los símbolos que puede hallar en la unidad.















Definición de los símbolos hallados en la unidad			
			
Encendido (alimentación eléctrica) IEC 417, N° 5007	Apagado (alimentación eléctrica) IEC 417, N° 5008	Puesta a tierra IEC 417, N° 5017	Protección a tierra IEC 417, N° 5019
			
Caja o chasis IEC 417, N° 5020	Equipotencialidad IEC 417, N° 5021	Corriente continua IEC 417, N° 5031	Corriente alterna IEC 417, N° 5032
			
Corriente continua y alterna IEC 417, N° 5033-a	Equipo de clase II IEC 417, N° 5172-a	Corriente alterna trifásica IEC 617-2, N° 020206	
			
Precaución. Consulte los documentos adjuntos ISO 3864, N° B.3.1	Precaución. Riesgo de descarga eléctrica ISO 3864, N° B.3.6	Precaución. Superficie caliente IEC 417, N° 5041	

Tabla 4: Definición de los símbolos hallados en la unidad

Procedimientos y precauciones de seguridad

Las precauciones generales de seguridad descritas a continuación deben observarse durante todas las etapas de funcionamiento de la válvula. La falta de cumplimiento de dichas precauciones o de las advertencias específicas a las que se hace referencia en el manual, constituye una violación de las normas de seguridad establecidas para el uso previsto de la válvula y podría anular la protección proporcionada por el equipo. Si el cliente no cumple dichas precauciones y advertencias, MKS Instruments, Inc. no asume responsabilidad legal alguna.

Advertencia



Hasta que la válvula sea incorporada en forma segura al sistema, las piezas en movimiento presentes en la misma pueden causar daños personales. Para evitarlo, mantenga todo el cuerpo alejado de la abertura de válvula.

- 1. No introduzca por las aberturas objetos que puedan entrar en contacto con piezas en movimiento.**
 - 2. Antes de tocar la válvula, aíslala de toda fuente de alimentación neumática o eléctrica.**
-

NO UTILICE PIEZAS NO ORIGINALES O MODIFIQUE LA VÁLVULA

No instale piezas que no sean originales o modifique la válvula sin autorización. Para asegurar el correcto funcionamiento de todos los dispositivos de seguridad, envíe la válvula al Centro de servicio y calibración de MKS toda vez que sea necesario efectuar reparaciones o tareas de mantenimiento.

LAS REPARACIONES DEBEN SER EFECTUADAS ÚNICAMENTE POR TÉCNICOS AUTORIZADOS

Los operarios no deben intentar reemplazar los componentes o realizar tareas de ajuste en el interior. Las tareas de mantenimiento o reparación deben ser realizadas únicamente por personal autorizado.

TENGA CUIDADO CUANDO TRABAJE CON MATERIALES TÓXICOS

Cuando se utilicen materiales tóxicos, los operarios deberán cumplir las medidas de seguridad correspondientes, purgar totalmente la válvula cuando sea necesario y comprobar que el material utilizado sea compatible con los materiales humedecidos del instrumento e inclusive, con los materiales de sellado.

PURGUE LA VÁLVULA

Una vez instalada la unidad o antes de retirarla del sistema, purgue completamente la unidad con gas limpio y seco para eliminar todo resto de la sustancia líquida empleada anteriormente.

USE PROCEDIMIENTOS ADECUADOS PARA REALIZAR LA PURGA

La válvula debe purgarse debajo de una campana de ventilación y deben utilizarse guantes protectores.

NO HAGA FUNCIONAR LA VÁLVULA EN UN AMBIENTE CON RIESGO DE EXPLOSIONES

Para evitar que se produzcan explosiones, no haga funcionar este producto en un ambiente con riesgo de explosiones, excepto cuando el mismo haya sido certificado específicamente para tal uso.

USE ACCESORIOS ADECUADOS Y REALICE CORRECTAMENTE LOS PROCEDIMIENTOS DE AJUSTE

Todos los accesorios de la válvula deben cumplir las especificaciones de la misma y ser compatibles con el uso que se debe dar a la válvula. Arme y ajuste los accesorios de acuerdo con las instrucciones del fabricante.

COMPRUEBE QUE LAS CONEXIONES SEAN A PRUEBA DE FUGAS

Inspeccione cuidadosamente las conexiones de los componentes de vacío para comprobar que hayan sido instalados a prueba de fugas.

HAGA FUNCIONAR LA VÁLVULA CON PRESIONES DE ENTRADA SEGURAS

No haga funcionar nunca la válvula con presiones superiores a la máxima presión nominal (en las especificaciones del instrumento hallará la presión máxima permitida).

INSTALE UNA CÁPSULA DE SEGURIDAD ADECUADA

Cuando el instrumento funcione con una fuente de gas presurizado, instale una cápsula de seguridad adecuada en el sistema de vacío para evitar que se produzcan explosiones cuando suba la presión del sistema.

MANTENGA LA UNIDAD LIBRE DE CONTAMINANTES

No permita el ingreso de contaminantes en la unidad antes o durante su uso. Los productos contaminantes tales como polvo, suciedad, pelusa, lascas de vidrio o virutas de metal pueden dañar irreparablemente la unidad o contaminar el proceso.

MANTÉNGASE ALEJADO DE LA ABERTURA DE LA VÁLVULA

Cuando la válvula esté funcionando, mantenga los dedos, otras partes del cuerpo y otros materiales alejados de la abertura.

Chapter One: General Information

Introduction

The Type 153E “Smart” Throttle Valve Controller is designed for use in downstream pressure control applications. The 153 unit includes a “built-in” MKS Type 253 Throttle Valve, a microprocessor, RS-232 communication connections, and driver circuits. The driver circuits eliminate the need for a separate controller box.

The 153 controller contains a digital pressure/position control algorithm that directs the 253 valve to the proper position for either pressure or position control. The pressure or position set point may be an external voltage applied to the Input connector, or sent as a digital RS-232 message. The 153 unit reads the pressure signal used for control applications directly from a pressure transducer.

Power for the 153 unit can be a single DC supply of +15 to +30 Volts. You can use a +15 VDC, +24 VDC, or +28 VDC supply. The unit requires approximately 6 Watts of power.

Note

Use a ± 15 V supply to power the 153 unit if you plan to power a transducer from the 153 unit.

When the controller is turned off, or experiences an unexpected power loss, all calibration constants and the last valve position are saved in non-volatile memory. Therefore, when you repower the unit, it will be calibrated and ready for operation.

A switch on the top of the controller allows for off-line operation of the valve for troubleshooting. Dipswitches inside the controller allow you to select the:

- Set Point Control (pressure or position)
- Set Point Signal (analog or digital)
- Valve Action (normal or reverse)
- Output Voltage Range (0 to 10 V or 0 to 5 V)
- RS-232 Operating Protocol (portable terminal or computer)
- RS-232 Communication Parameters (baud rate, parity, end-of-line delimiter)

The 153 controller meets the testing standards required for the European CE mark when used with an overall metal braided shielded cable, properly grounded at both ends. The unit is available with a variety of flanges and has an ambient operating temperature range of 15° to 50° C (59° to 122° F).

How This Manual is Organized

This manual is designed to provide instructions on how to set up, install, and operate a Type 153 unit.

Before installing your Type 153 unit in a system and/or operating it, carefully read and familiarize yourself with all precautionary notes in the *Safety Messages and Procedures* section at the front of this manual. In addition, observe and obey all WARNING and CAUTION notes provided throughout the manual.

Chapter One, *General Information*, (this chapter) introduces the product and describes the organization of the manual.

Chapter Two, *Installation*, explains the environmental requirements and describes how to mount the instrument in your system.

Chapter Three, *Overview*, gives a brief description of the instrument and its functionality.

Chapter Four, *Operation*, describes how to use the instrument and explains all the functions and features.

Chapter Five, *Maintenance and Troubleshooting*, lists any maintenance required to keep the instrument in good working condition, and provides information for reference should the instrument malfunction.

Appendix A, *Product Specifications*, lists the specifications of the instrument.

Appendix B, *Model Code Explanation*, describes the model code used to order the instrument.

Customer Support

Standard maintenance and repair services are available at all of our regional MKS Calibration and Service Centers, listed on the back cover. In addition, MKS accepts the instruments of other manufacturers for recalibration using the Primary and Transfer Standard calibration equipment located at all of our regional service centers. Should any difficulties arise in the use of your Type 153 instrument, or to obtain information about companion products MKS offers, contact any authorized MKS Calibration and Service Center. If it is necessary to return the instrument to MKS, please obtain an ERA Number (Equipment Return Authorization Number) from the MKS Calibration and Service Center before shipping. The ERA Number expedites handling and ensures proper servicing of your instrument.

Please refer to the inside of the back cover of this manual for a list of MKS Calibration and Service Centers.

Warning



All returns to MKS Instruments must be free of harmful, corrosive, radioactive, or toxic materials.

Chapter Two: Installation

How To Unpack the Type 153 Unit

MKS has carefully packed the Type 153 unit so that it will reach you in perfect operating order. Upon receiving the unit, however, you should check for defects, cracks, broken connectors, etc., to be certain that damage has not occurred during shipment.

Note

1. Do *not* discard any packing materials until you have completed your inspection and are sure the unit arrived safely.
 2. Leave the protective plastic caps, which are placed over the ports for shipment, on the valve until it is installed in the system. Do not discard the protective plastic caps; if you remove the valve from your system, use the plastic caps to protect the ports.
-

If you find any damage, notify your carrier and MKS immediately. If it is necessary to return the unit to MKS, obtain an ERA Number (Equipment Return Authorization Number) from the MKS Service Center before shipping. Please refer to the inside of the back cover of this manual for a list of MKS Calibration and Service Centers.

Caution

Only qualified individuals should perform the installation and any user adjustments. They must comply with all the necessary ESD and handling precautions while installing and adjusting the instrument. Proper handling is essential when working with all highly sensitive precision electronic instruments.

Unpacking Checklist

Standard Equipment:

- Type 153 Unit
- Type 153 Instruction Manual (this book)

Optional Equipment:

- Electrical Connector Accessory Kit (153E-K1)
- Power Supply: 260 PS-1 (± 15 V, 1.5 Amps)
260 PS-3 (± 15 V, 3.2 Amps)
- PT-1 Portable RS-232 Terminal
- Interface Cables (refer to Table 5, page 20)

Interface Cables

As of January 1, 1996, most products shipped to the European Community must comply with the EMC Directive 89/336/EEC, which covers radio frequency emissions and immunity tests. In addition, as of January 1, 1997, some products shipped to the European Community must also comply with the Product Safety Directive 92/59/EEC and Low Voltage Directive 73/23/EEC, which cover general safety practices for design and workmanship. MKS products that meet these requirements are identified by application of the CE Mark.

To ensure compliance with EMC Directive 89/336/EEC, an overall metal braided shielded cable, properly grounded at both ends, is required during use. No additional installation requirements are necessary to ensure compliance with Directives 92/59/EEC and 73/23/EEC.

Note



1. An overall metal braided shielded cable, properly grounded at both ends, is required during use to meet CE specifications.
2. To order an overall metal braided shielded cable, add an “S” after the cable type designation. For example, to order a standard cable to connect a 153 unit to a 627 transducer, use part number CB153-7-10; for a metal braided shielded cable, use part number CB153S-7-10.

You can purchase interface cables to all MKS companion products from MKS (refer to Table 5), or optionally, you can make cables that meet the appropriate cable specifications.

For cables that will be connected to non-MKS products, MKS can provide normal shielding or braided shielded cable assemblies in a nominal 10’ (3m) length, terminating in *flying leads* (pigtail) fashion at both ends. MKS recommends braided shielded cable assemblies if the environment contains high EMI/RFI noise.

Interface Cables		
To Connect the 153 Unit To...	Use the MKS Cable...	
	Standard	Shielded
Type 260 PS-1 and 260 PS-3 power supplies	CB153-1-10	CB153S-1-10
Type 270/690 system	CB153-6-10	CB153S-6-10
Type 127, 128, 624, 625, 626, 627, and 628 transducers	CB153-7-10	CB153S-7-10
Type 122, 124, 622, and 623 transducers	CB153-8-10	CB153S-8-10
Type 146 unit (with a power supply)	CB153-13-10	CB153S-13-10
“Y” RS-232C cable	CB153-14-10	CB153S-14-10
PT-1 Portable RS-232 Terminal	CB153-18-1	CB153S-18-1

Table 5: Interface Cables

Generic Shielded Cables

Should you choose to manufacture your own cables, follow the guidelines listed below:

1. The cable must have an overall metal *braided* shield, covering all wires. Neither aluminum foil nor spiral shielding will be as effective; using either may nullify regulatory compliance.
2. The connectors must have a metal case which has direct contact to the cable's shield on the whole circumference of the cable. The inductance of a flying lead or wire from the shield to the connector will seriously degrade the shield's effectiveness. The shield should be grounded to the connector before its internal wires exit.
3. With very few exceptions, the connector(s) must make good contact to the device's case (ground). "Good contact" is about 0.01 ohms; and the ground should surround all wires. Contact to ground at just one point may not suffice.
4. For shielded cables with flying leads at one or both ends; it is important at each such end, to ground the shield *before* the wires exit. Make this ground with absolute minimum length. Refer to Figures 1 and 2, page 22. (A ¼ inch piece of #22 wire may be undesirably long since it has approximately 5 nH of inductance, equivalent to 31 ohms at 1000 MHz). After picking up the braid's ground, keep wires and braid flat against the case. With very few exceptions, grounded metal covers are not required over terminal strips. If one is required, it will be stated in the Declaration of Conformity or in the instruction manual.
5. In selecting the appropriate type and wire size for cables, consider:
 - A. The voltage ratings.
 - B. The cumulative I^2R heating of all the conductors (keep them safely cool).
 - C. The IR drop of the conductors, so that adequate power or signal voltage gets to the device.
 - D. The capacitance and inductance of cables which are handling fast signals, (such as data lines or stepper motor drive cables).
 - E. That some cables may need internal shielding from specific wires to others; please see the instruction manual for details regarding this matter.

Example 1: Preferred Method To Connect Cable
(shown on a transducer)

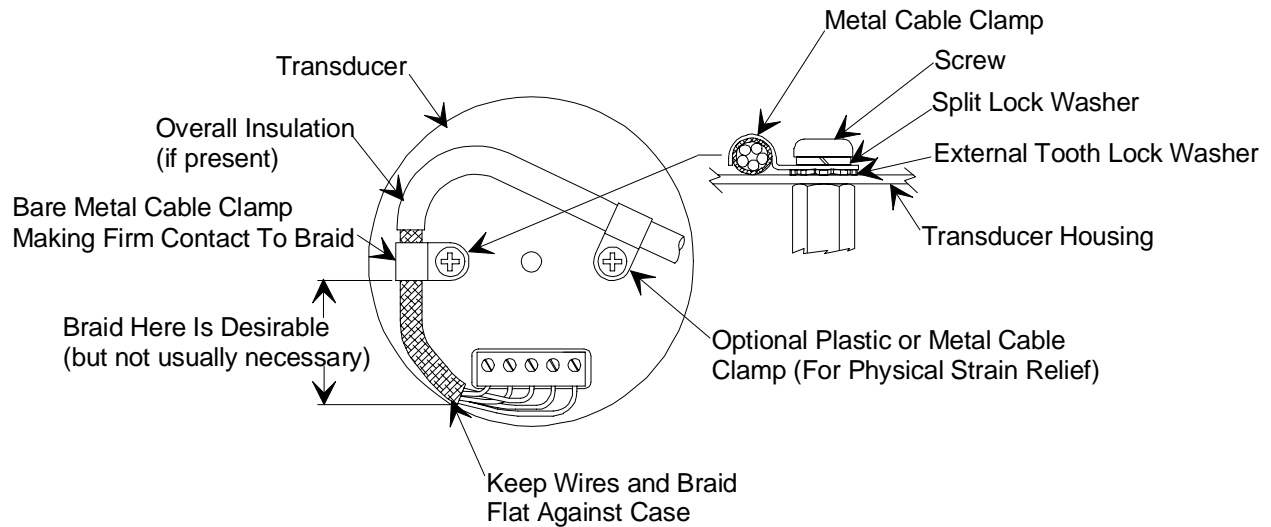

Figure 1: Preferred Method To Connect an Overall Metal Braided Shielded Cable

Example 2: Alternate Method To Connect Cable
(shown on a transducer)

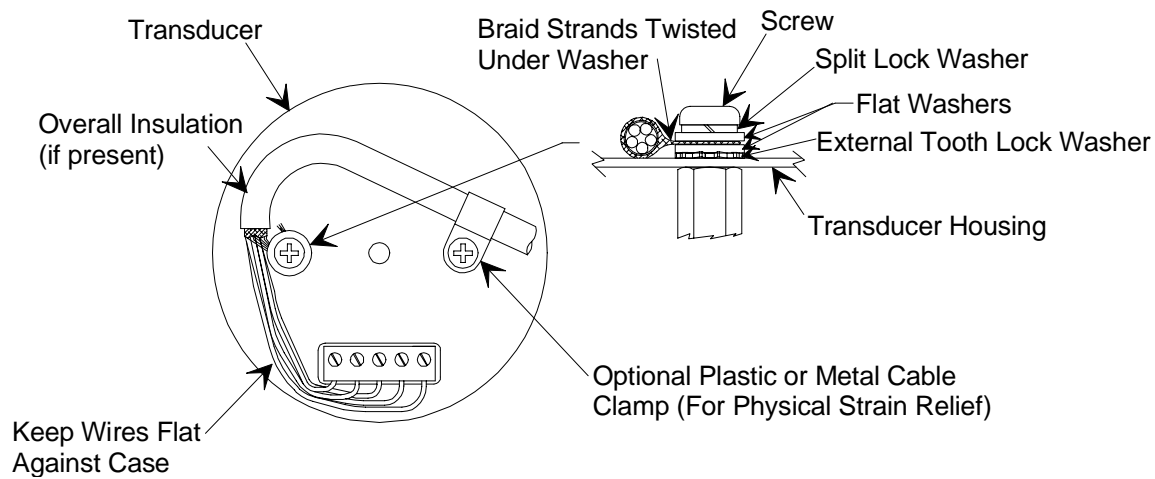

Figure 2: Alternate Method To Connect an Overall Metal Braided Shielded Cable
Use this method when cable clamp is not available

Setup

Dimensions

Note



1. All dimensions are listed in inches with millimeters referenced in parentheses. The tolerances for the dimensions are ± 0.1 (X.X) and ± 0.01 (X.XX).
2. The 153 unit is available with five flange types: ASA, NW Style ISO, KF Style ISO, CF, and JIS. Complete dimensions for each flange option are listed in *Appendix A: Product Specifications*, page 85.

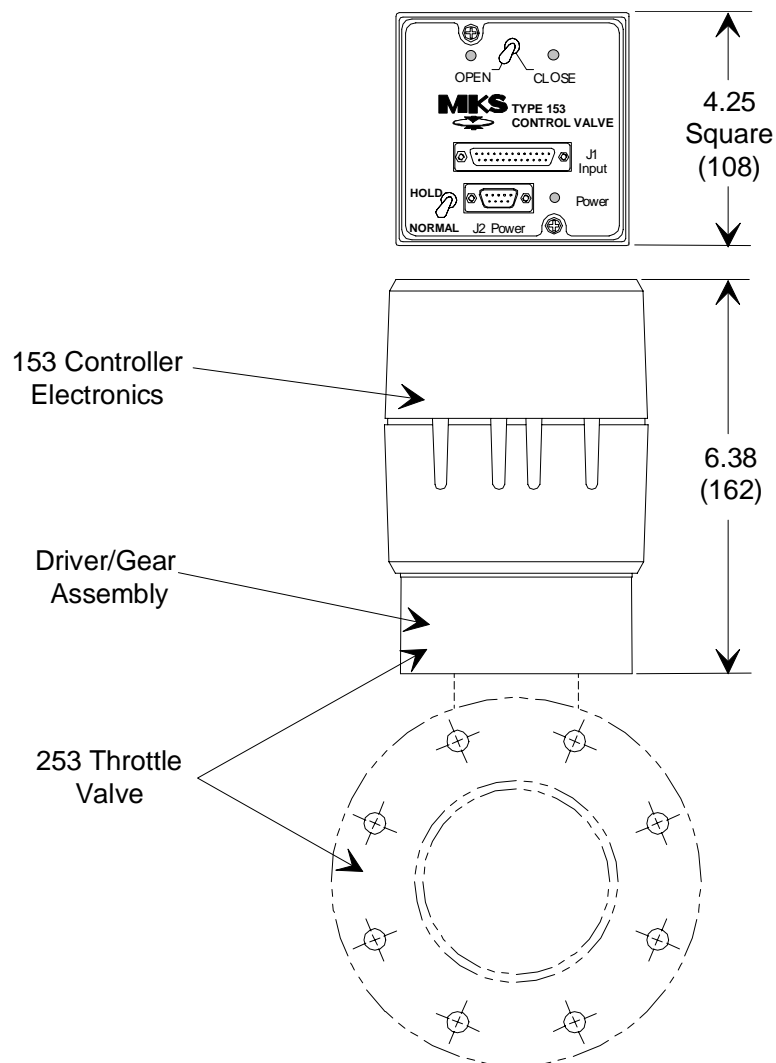

Figure 3: Type 153 Controller Dimensions

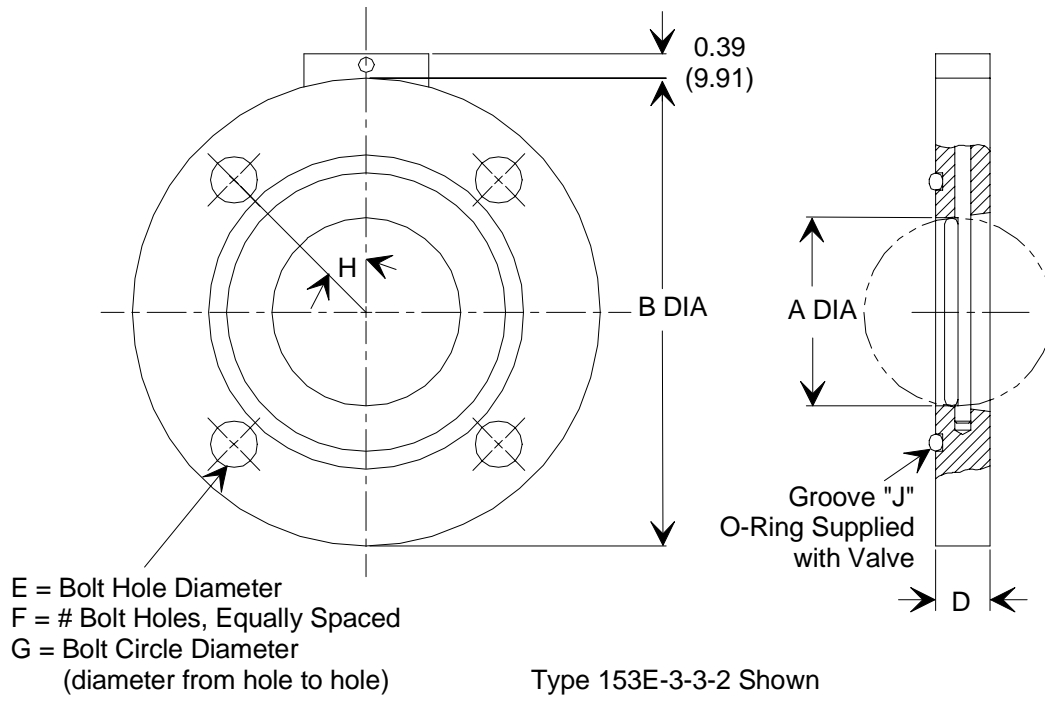

Figure 4: Outline Dimensions of an ASA Flange

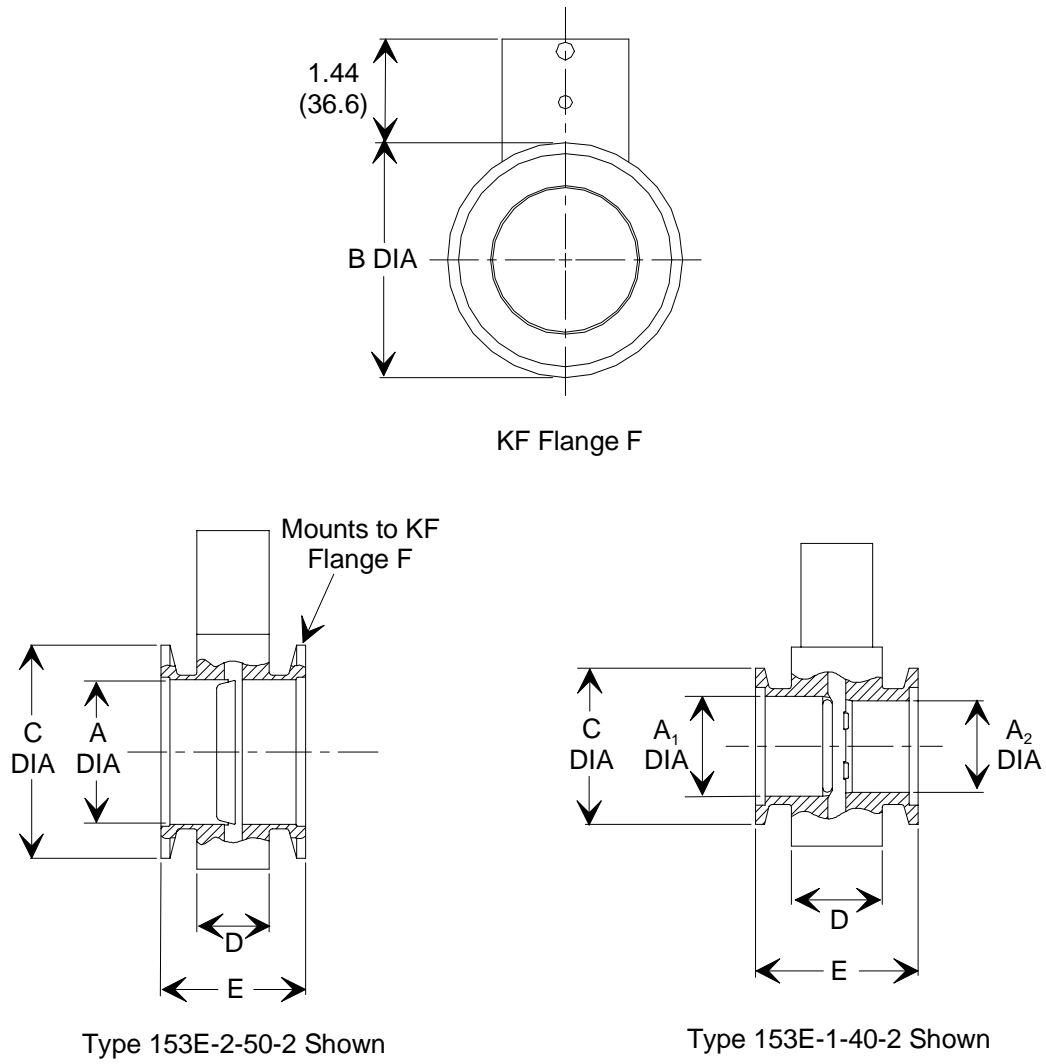

Figure 5: Outline Dimensions of a KF Style ISO Flange

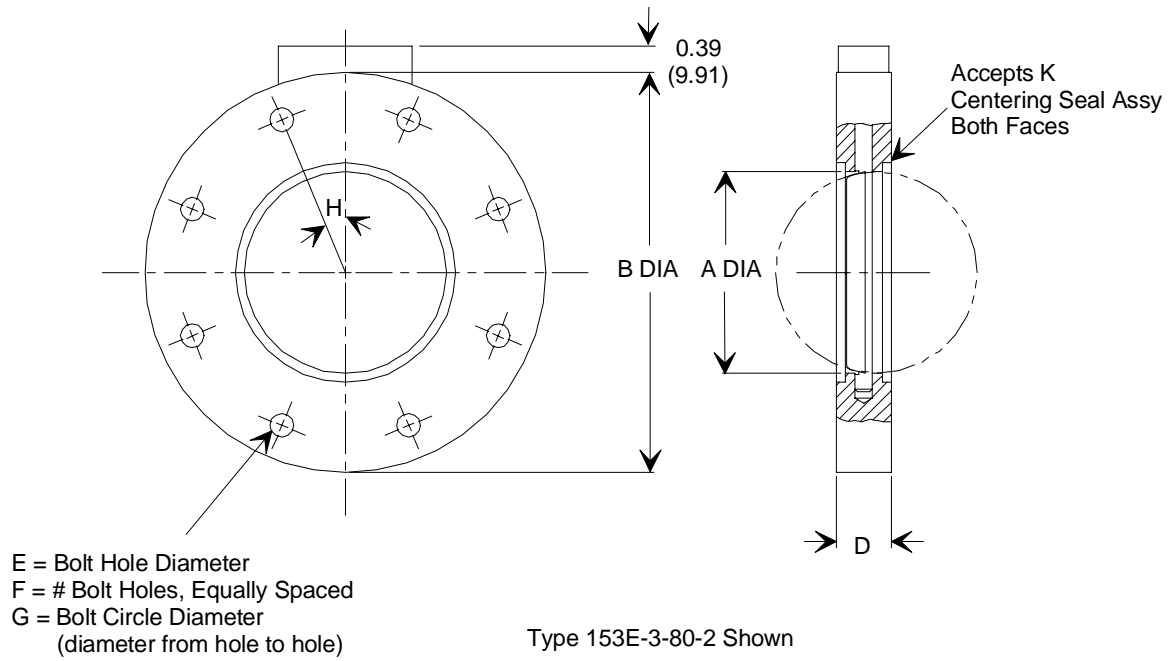

Figure 6: Outline Dimensions of a NW Style ISO Flange

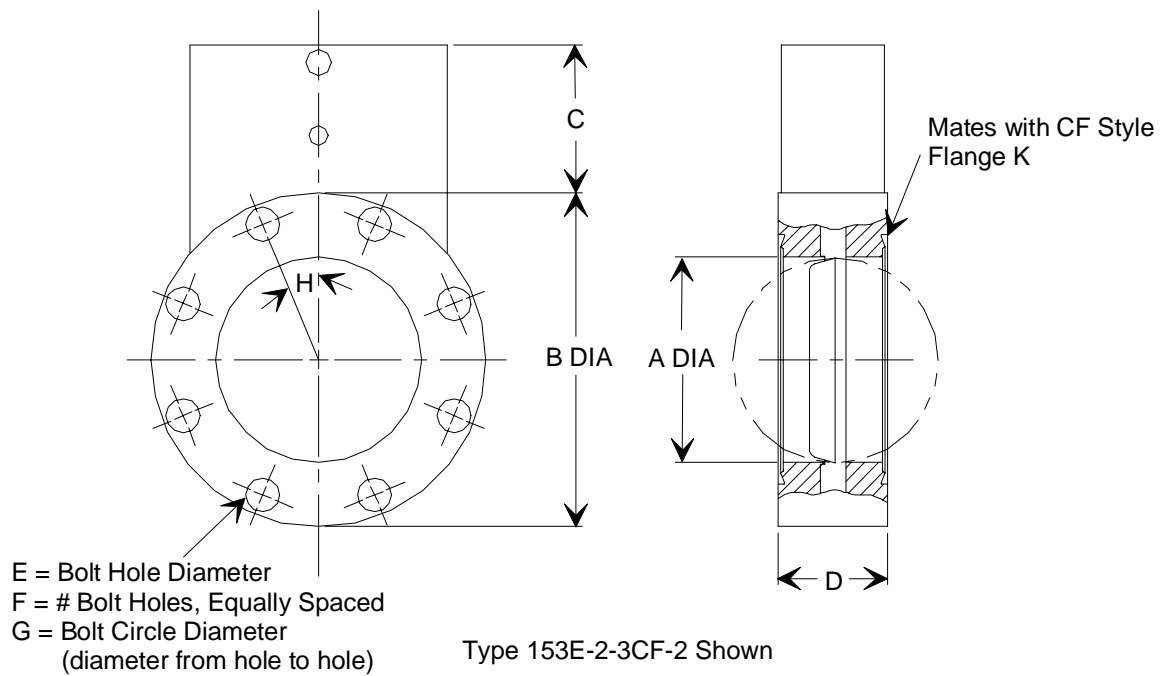

Figure 7: Outline Dimensions of a CF Flange

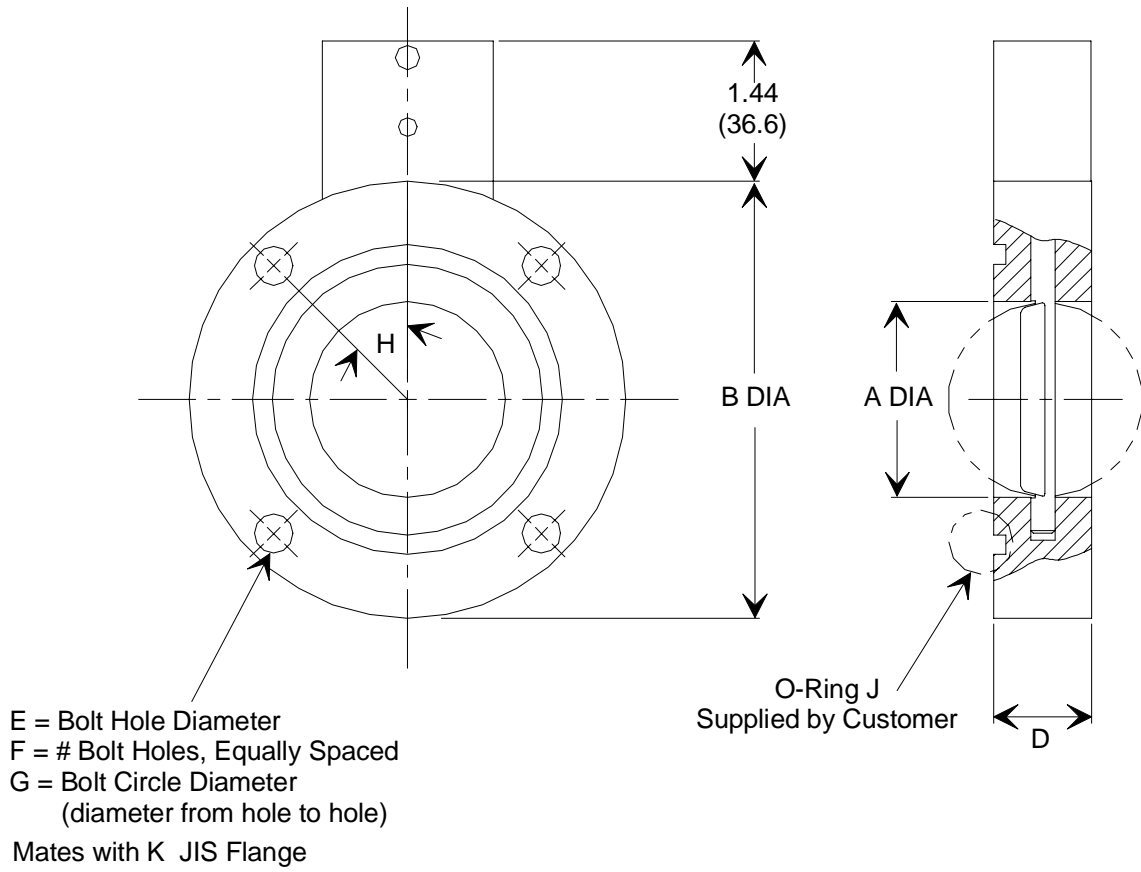

Figure 8: Outline Dimensions of a JIS Flange

O-Ring Material

Valves that have an O-ring sealed flapper are called sealing butterfly valves. This design ensures closed leak rates less than 1.3×10^{-7} scc/sec when new. Ensure that the O-ring material is compatible with the gases it will be exposed to in the system.

Power Requirements

The 253 valve, enclosed in the 153 unit, requires +15 to +30 Volts. If you need to power a pressure transducer, you must supply ± 15 VDC to the 153 unit. The 153 unit uses the +15 Volts and sends the ± 15 Volts on to the pressure transducer. Both the Input connector and the Power connector provide connections for ± 15 Volts and the pressure signal. The system shown in Figure 10, page 31, receives ± 15 Volts through the Input connector and interfaces with the pressure transducer through the Power connector. The interface cables are listed in Table 5, page 20.

The 153 controller can receive a set point signal from either an external voltage source or an RS-232 signal. In either case, the Input connector (which incorporates the RS-232 communications) acts as the interface. Figure 10, page 31, shows an external voltage source connected as the set point signal. Refer to Table 7, page 33, for the Input connector pinout.

Grounding

The pressure and set point inputs to the 153 controller are both differential inputs that are not internally referenced to ground. Tie the returns to the system ground at a single point. Figure 9, page 29, illustrates this type of grounding.

Note



Not grounding the set point return or the pressure return (floating) can induce noise into the signals.

The 153 controller uses true differential inputs for the pressure and set point input signals. You must connect the return leads to the power supply ground at a single point. Grounding at multiple points will produce ground loops and IR drops which will degrade performance.

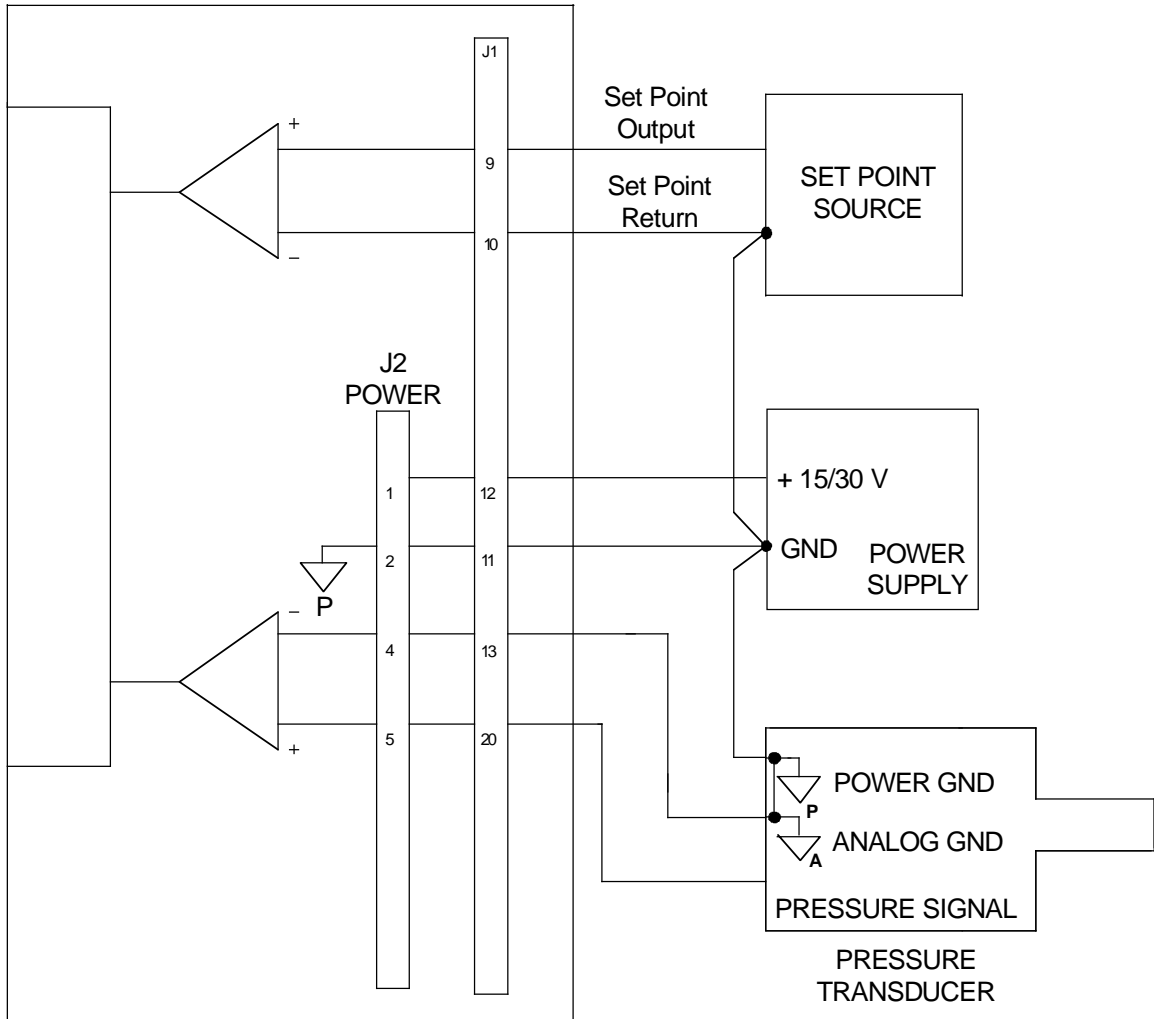

Figure 9: Returned Leads Tied to System Ground

Mounting Instructions

Warning



The moving parts in the valve create a risk of personal injury until the valve is securely incorporated into a system. To avoid injury keep all objects away from any valve opening.

The 153 unit can be mounted in a vacuum exhaust line with the proper fittings and connectors. The unit consists of a 253 exhaust valve with an electronic housing attached to the motor plate.

Although the unit was designed and tested to operate in the most extreme conditions (with no air circulation and a heated valve at 80° C), it will operate cooler if the air slots in the side of the housing are clear to allow convection air circulation. Typically, electronic components last longer in cooler environments.

Heated Valves

The 153 unit is *not* designed to operate with a heated valve unless certain modifications are made. Some installations require that the exhaust line and throttle valve be heated to prevent exhaust vapors from precipitating out in the exhaust line. For these types of applications, contact MKS Instruments.

System Configuration

For best pressure control, locate the pressure transducer and exhaust valve as close as practical to the process chamber. This minimizes the time constants associated with these items. Use tubing that is less than 6 inches long and no less than ¼ inch in diameter to connect the transducer and chamber. If the distance must exceed 6 inches, use larger diameter tubing to compensate for conductance losses. A typical system setup is shown in Figure 10, page 31.

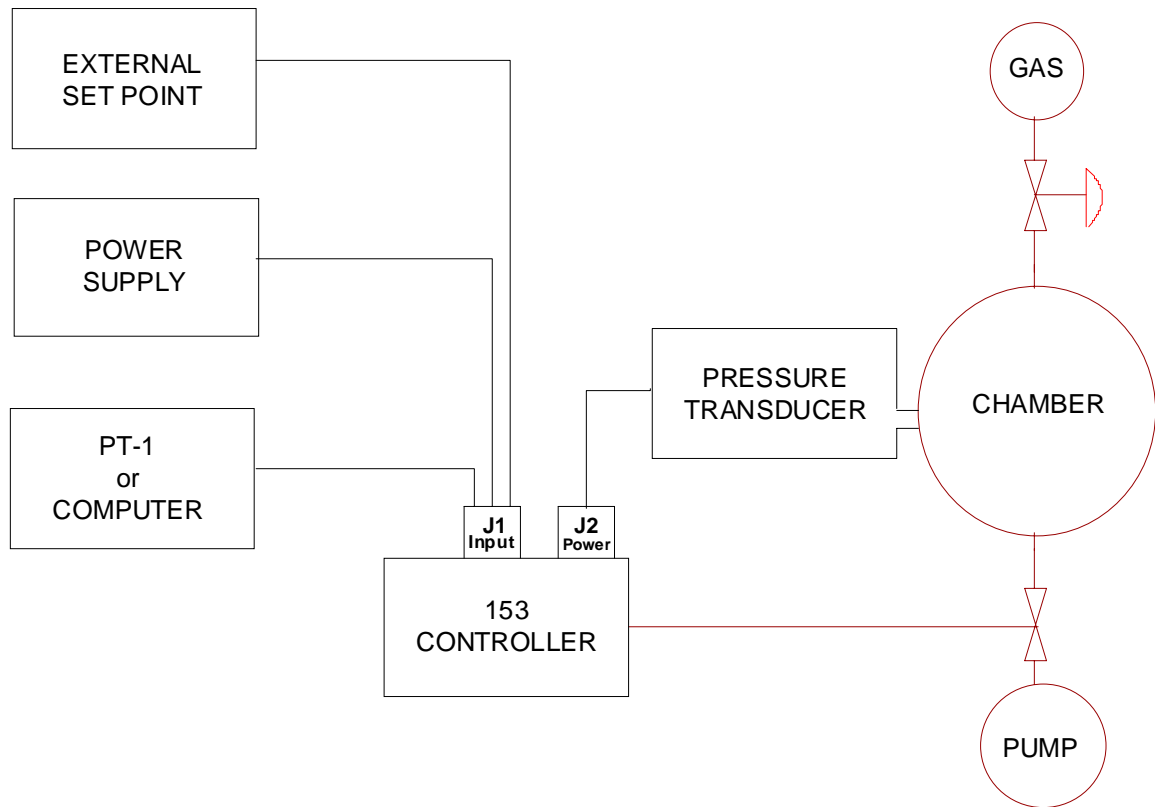

Figure 10: Typical System Configuration

Connectors

There are two connectors on the top panel of the 153 controller (refer to Figure 16, page 42): a Power connector and an Input connector. The interface cables are listed in Table 5, page 20.

Power Connector (J2)

The 9-pin male Type “D” connector contains the pins for the power input, pressure input, and the limit-switch outputs.

Power Connector (J2) Pinout		
Pin	Assignment	Also connects to J1 Pin
1	+15 to +30 Volt DC Power Supply Input	12
2	Power Supply Common (Return for power supply)	11
3	-15 V (External supply to transducer)	21
4	Pressure Signal Common (Lo side)	13
5	Pressure Signal Input (Hi side)	20
6	Limit-Switch Common	24
7	Open Limit-Switch Output	22
8	Close Limit-Switch Output	23
9	Chassis Ground	1, 25

Table 6: Power Connector (J2) Pinout

Input Connector (J1)

The 25-pin female Type “D” connector contains the pins for the pressure input, set point input, RS-232 communications, power supply input, limit-switch outputs, pressure output, and valve position output.

Input Connector (J1) Pinout		
Pin	Assignment	Also connects to J2 Pin
1	Chassis Ground	9
2	TX (RS-232)	
3	RXD (RS-232)	
4	Pressure Output	
5	Pressure/Valve Position Return	
6	Valve Position Output	
7	Digital Common	
8	+5 Volt Output (Powers portable terminal)	
9	Set Point Input (Hi side)	
10	Set Point Return (Lo side)	
11	Power Supply Common (Return for power supply)	2
12	+15/30 V Power Supply Input	1
13	Pressure Signal Common (Lo side)	4
14	No Connection	
15	Control Type (Pressure/Position) Override* Pull LOW to override dipswitch 8; Float HIGH for no override (default)	
16	No Connection	
17	Pressure/Valve Position Return	
18	Manual Close Command Line	
19	Manual Open Command Line	

Table 7: Input Connector (J1) Pinout
(Continued on next page)

Input Connector (J1) Pinout (Continued)		
Pin	Assignment	Also connects to J2 Pin
20	Pressure Signal Input (Hi side)	5
21	-15 V (External supply to transducer)	3
22	Open Limit-Switch Output	7
23	Close Limit-Switch Output	8
24	Limit-Switch Common	6
25	Chassis Ground	9
<i>* Refer to Dipswitch Bank, page 44, for more information.</i>		

Table 7: Input Connector (J1) Pinout

Note

The “No Connection” pin assignment refers to a pin with no internal connection.

Output Range for Pressure (Pin 4) and Valve Position (Pin 6)

The voltage range for the output on pin 4 and pin 6 on the Input connector is either 0 to +10 V (default), or 0 to +5 V. The voltage range is set with dipswitch 9 on the CPU board (refer to *Dipswitch Bank*, page 44, for more information).

Note

The outputs from the 153 controller can be adjusted using the digital RS-232 commands listed in Table 16, page 68. Refer to *How To Calibrate the System for Output Errors*, page 68, for more information.

The pressure output on pin 4 is a voltage that represents the actual pressure as a percent of the full scale pressure as shown in Table 8.

Example Pressure Outputs for Input Connector Pin 4		
Output Range	Voltage Reading	Pressure Is
0 to 10 V	10 V	100% of full scale
0 to 10 V	0 V	0% of full scale
0 to 10 V	7.5 V	75% of full scale
0 to 5 V	5 V	100% of full scale
0 to 5 V	3.75 V	75% of full scale

Table 8: Example Pressure Outputs for Input Connector Pin 4

The valve position output on pin 6 is a voltage that represents the actual valve position as a percent of full open as shown in Table 9.

Example Valve Position Outputs for Input Connector Pin 6		
Output Range	Voltage Reading	Position Is
0 to +10 V	+10 V	100% of full open
0 to +10 V	0 V	0% of full open
0 to 10 V	+7.5 V	75% of full open
0 to 5 V	+5 V	100% of full open
0 to 5 V	+3.75 V	75% of full open

Table 9: Example Valve Position Outputs for Input Connector Pin 6

How To Connect to a PT-1 Portable RS-232 Terminal

Note

The 153 controller's default communication parameters configure it to communicate with the PT-1 portable RS-232 terminal, rather than with a computer. The default communication parameters are listed in Table 12, page 52.

The default dipswitch settings are listed in Table 10, page 45. Refer to *How To Change the Dipswitch Settings*, page 47, for more information.

The PT-1 portable terminal is shipped with its RS-232 communication cable attached. To connect the PT-1 unit to the 153 controller:

1. Ensure that dipswitch 6 on the CPU board is in the ON (closed) position.
This is the default position for dipswitch 6. When dipswitch 6 is ON, the 153 unit is configured to communicate with the PT-1 unit.
2. Plug the Type "D" connector from the cable on the PT-1 unit into the Input connector on the top of the 153 unit.

Refer to Figure 16, page 42.

How To Connect to a Computer

Note



The default communication parameters configure the 153 unit to communicate with the portable RS-232 terminal, rather than with a computer. To configure the 153 unit so that it can communicate with a computer, you must change the setting of dipswitch 6 on the CPU board to the OFF (open) position.

The default dipswitch settings are listed in Table 10, page 45. Refer to *How To Change the Dipswitch Settings*, page 47, for more information.

To connect your 153 controller to a computer:

1. Ensure that dipswitch 6 on the CPU board is in the OFF (open) position.

This is *not* the default position for dipswitch 6. When dipswitch 6 is OFF the 153 unit is configured to communicate with a computer.

2. Connect a null modem cable from your computer to the Input connector on the top of the 153 unit.

Refer to Figure 16, page 42.

Note



You must use a *null modem* RS-232 cable to connect the 153 unit to a computer. A null modem cable has pins 2 and 3 reversed from one end of the cable to the other. Any commercial RS-232 cable may be used as long as the pin reversal is made. Figure 11 shows the pin assignments on a null modem cable.

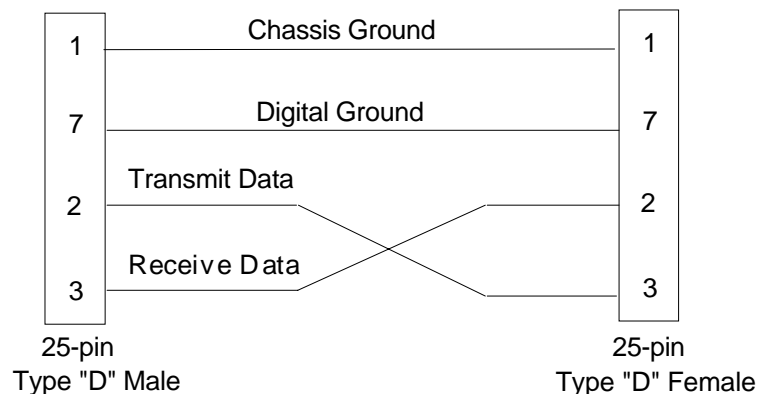

Figure 11: Null Modem RS-232 Communication Cable

How To Connect to a Type 146 Cluster Gauge™

The MKS Type 146 Cluster Gauge can be used to control the 153 unit. To configure the 153 unit to communicate with the 146 instrument, leave the dipswitches at the default settings (refer to Table 10, page 45) *except for switch 8*. Set switch 8 to the OFF (Closed) position, so the 153 unit will act as a position controller. The system will then use the PID control on the 146 instrument to control the valve. Refer to *How To Change the Dipswitch Settings*, page 47, for instructions on how to change the position of dipswitch 8.

Note

The 146 instrument must contain the optional “M” board (Control Board) to control the 153 unit.

1. Connect the 153 controller to the “M” board (Control Board) in the 146 instrument using the appropriate cable.

The Control Board has two 9-pin Type “D” connectors: one male and one female. The cable uses the 146 instrument to power the 153 unit and provides the analog voltage to position the valve to control pressure. The interface cables are listed in Table 5, page 20.

2. Use the Setup Mode Code 14x on the 146 instrument to select the control action (direct for downstream control) and the pressure reference channel.
3. Use the Open and Close commands on the 146 instrument to move the valve from fully open to fully closed.
4. Watch the Open and Close LED lights on the 153 unit.

Refer to Figure 16, page 42. If the appropriate light is illuminated when the valve is in position, the zero and full scale settings are correct. If the appropriate light is not illuminated correctly, proceed to step 5.

5. Calibrate the 153 controller using either a computer or a PT-1 portable terminal.

The controller will learn the new values for zero and full scale for the controller and transducer. Refer to *Calibration Messages*, page 62, for more information.

Chapter Three: Overview

Control Mode

The 153 controller controls a vacuum system using either Pressure or Position control. In either the Pressure Control or Position Control mode, the 153 controller accepts the following types of set points:

- An analog set point sent to the controller via the Input connector
- A digital set point sent to the controller using RS-232 commands from a computer or a PT-1 unit

In *Pressure Control*, the 153 unit moves the valve in order to maintain a desired pressure (the set point). The controller uses a Proportional, Integral, and Derivative (PID) algorithm to determine the valve position and make position adjustments. The set point uses two parameters—the lead and gain—to optimize the response from set point to set point. Although there are default values for these parameters, you should adjust the values for optimum control (refer to *How To Tune the Controller*, page 78, for more information). The feedback is an analog pressure signal. This signal is normally 0 to 10 Volts, but the zero and full scale voltages can be adapted to individual applications. Refer to *Calibration Messages*, page 62, for more information.

In *Position Control*, the 153 unit moves the valve to a desired position (the set point). In this mode, the valve is moved to the desired set point but no feedback signal is generated. It is not necessary for the controller to make adjustments once the valve reaches its set point.

Lead and Gain

The 153 unit uses a PID compensator to control pressure in a vacuum system. When a new set point is commanded, the unit responds by changing the pressure smoothly to the desired value. If the pressure is slow to change or oscillates, the PID compensator must be re-tuned. The lead and gain values can be manually adjusted to provide the best response to the set point. By careful adjustment of each value, it is possible to achieve optimum control throughout a wide range of pressure regions.

The lead and gain values used in the control algorithm are set at the factory. You can change these parameters by using either a computer or a PT-1 unit to send the RS-232 commands listed in Table 13, page 57. These parameters are adjusted using the procedure described in *How To Tune the Controller*, page 78.

Lead

The lead provides a control signal that is proportional to the change in the error signal. The error signal is the difference between the actual pressure and the set point. The lead is responsible for controlling how quickly the pressure responds to a change in set point. A large lead generally results in a faster response to set point. However, if the lead is too large, the system will be slow in responding to set point, and, in some cases, may oscillate around the set point (refer to Figure 12). If the lead is too small, the pressure will overshoot and then oscillate around the set point before settling in (refer to Figure 13).

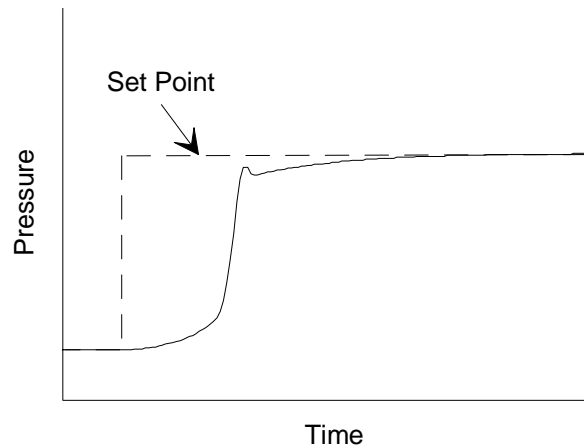

Figure 12: Lead Set Too High

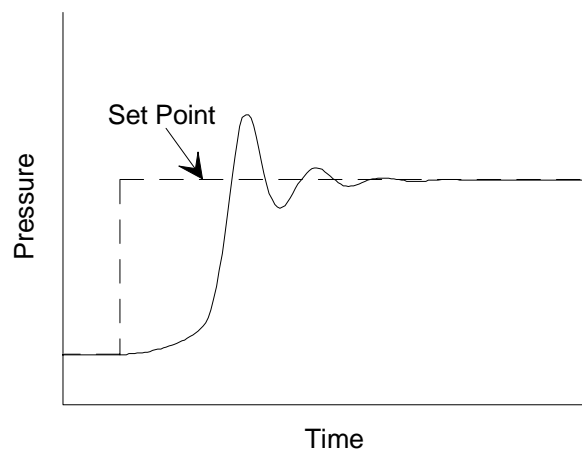

Figure 13: Lead Set Too Low

Gain

The gain provides a control signal that is proportional to the error signal. The gain is responsible for allowing the controller to track the set point with zero steady state error. The highest possible gain setting produces the best pressure control. A high gain setting generally results in a faster response to set point, and the best rejection of disturbances such as changes in flow rate or noise in the system. However, if the gain is too large, the pressure will overshoot the set point before settling in (refer to Figure 14). If the gain is too small, the pressure will respond slowly to a set point change (refer to Figure 15) or a change in flow rate.

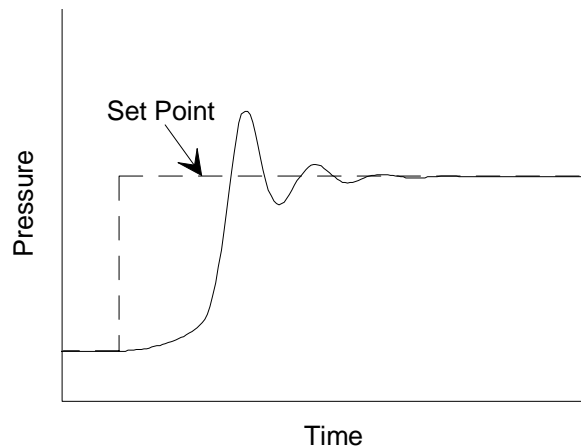

Figure 14: Gain Set Too High

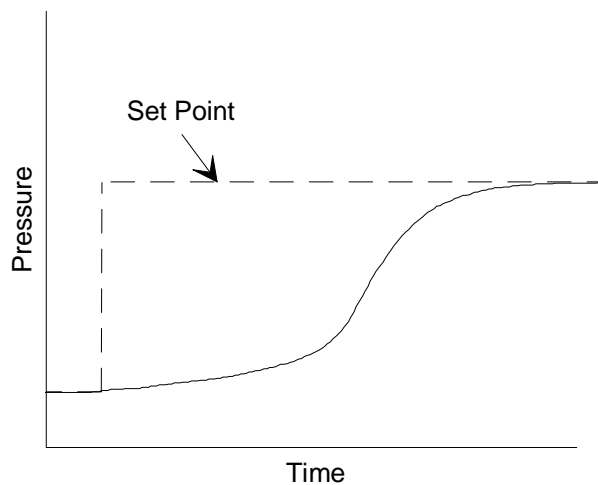

Figure 15: Gain Set Too Low

External Connectors and Controls

Figure 16 shows the location of the controls on the top panel of the 153 controller.

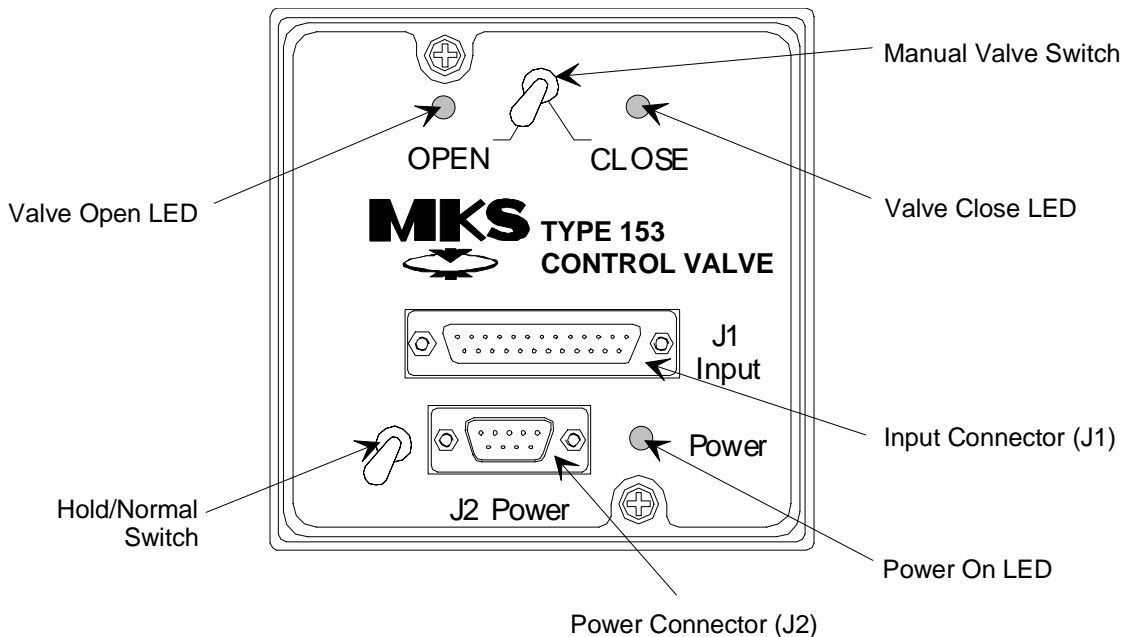

Figure 16: Top Panel of the 153 Controller

Power On LED

This LED indicator illuminates green when the unit is powered on.

Input Connector (J1)

The 25-pin female Type “D” contains the pins for the pressure input, set point input, RS-232 communications, power supply input, limit-switch outputs, pressure output, and valve position output. Refer to Table 7, page 33, for the Input connector pinout.

Power Connector (J2)

The 9-pin male Type “D” connector contains the pins for the power input, pressure input, and the limit-switch outputs. Refer to Table 6, page 32, for the Power connector pinout.

Hold/Normal Switch

This switch allows you to manually hold the valve in a constant position. When the switch is in the NORMAL position, the valve operates in the standard way. When the switch is placed in the HOLD position, the valve is held in a constant position, and does not respond to the pressure or set point signals.

You can override the HOLD position by moving the manual valve switch from the OPEN or CLOSE position, or by using the OPEN or CLOSE RS-232 commands (refer to *Valve Position Messages*, page 59, for more information).

Manual Valve Switch

This switch allows you to manually drive the valve to the open or closed position.

Valve Open LED

The OPEN indicator light illuminates red when the valve is fully open.

Valve Close LED

The CLOSE indicator light illuminates red when the valve is fully closed.

Internal Controls

Dipswitch Bank

The dipswitch bank, located on the CPU board inside of the 153 controller, provides the connections for all of the internal controls. Refer to Figure 17 for the location of the dipswitch bank on the CPU board.

The dipswitch bank contains 10 switches which are used to change or set the operating parameters for the 153 controller. The functions assigned to each dipswitch and their initial settings are listed in Table 10, page 45.

Note



Refer to *How To Change the Dipswitch Settings*, page 47, for instructions on how to access the CPU board and change the dipswitch settings.

Dipswitch Bank

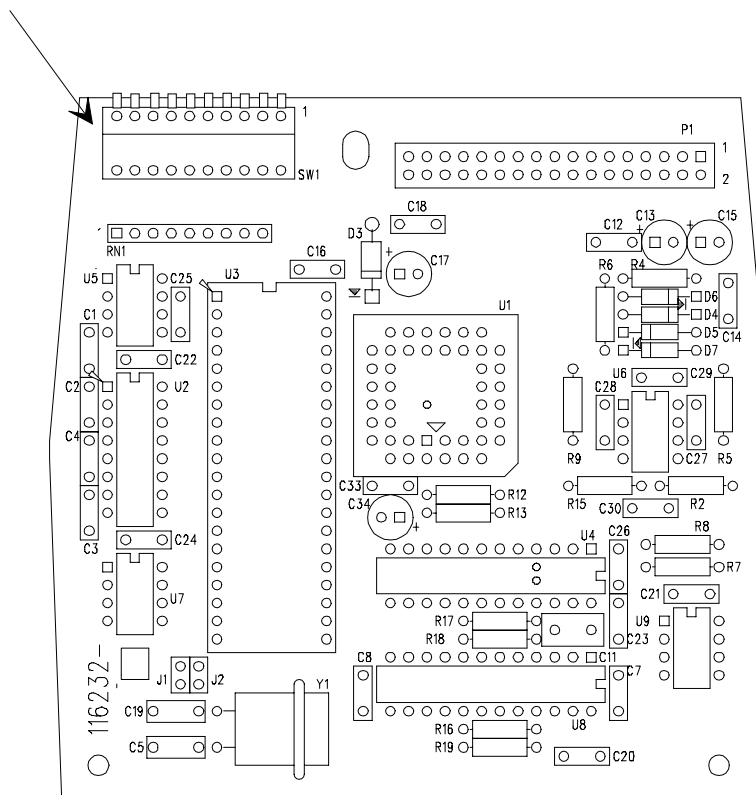

Figure 17: Location of the Dipswitch Bank on the CPU Board

Dipswitch Functions and Settings			
Dipswitch	Function	Switch Position	
		OFF (Open)	ON (Closed)
10	---	Spare - Reserved*	Spare - Reserved
9	Voltage Output Range	0 to 5 V output (High)	0 to 10 V output (Low*)
8	Set Point Control Type	Position Control	Pressure Control*
7	Set Point Signal Type	Digital	Analog*
6	RS-232 Operating Protocol	Standard RS-232 with a computer	PT-1 Portable RS-232 Terminal*
5	Parity	8 bit, None*	7 bit, Even
4	Baud Rate	1200	9600*
3	End-of-Line Delimiter	Carriage Return (CR)*	Carriage Return Line Feed (CRLF)
2	Set Point Value Entry	S xxx.x	S1 xxx.x*
1	Valve Action	Reverse	Normal*
<i>*Initial setting</i>			

Table 10: Dipswitch Functions and Settings

Switch 10: *Reserved.* This dipswitch is provided to support future functions. Leave it in the default OFF (Open) position.

Switch 9: *Selects the voltage output range for pins 4 and 6 on the Input connector.* When the switch is OFF, the unit's output is 0 to 5 V. When the switch is ON, the unit's output is 0 to 10 V.

Switch 8: *Selects the method of set point control.* When the switch is OFF, the 153 unit acts as a position controller; the unit moves the valve to a desired position (the set point). When the switch is ON, the unit acts as a pressure controller; the unit moves the valve in order to maintain a desired pressure (the set point).

Note

You can override the switch setting by pulling pin 15 low on the Input connector. To revert to the selected switch setting, float pin 15 high on the Input connector. By default pin 15 is high and, therefore, switch 8 determines the method of control. Refer to Table 7, page 33, for the Input connector pinout.

Switch 7: *Selects the source of the set point signal.* When the switch is OFF, the 153 controller expects to receive a digital set point signal through the RS-232 interface. When the switch is ON, the controller expects an external analog voltage set point signal on the Input connector.

You can override the analog set point by sending a Valve Position RS-232 command to the 153 controller (refer to Table 14, page 59). Use the standard protocol [A] command to revert back to an analog set point. Refer to *How To Return to Normal Operation*, page 61, for more information.

Switch 6: *Establishes the RS-232 operating protocol.* When the switch is OFF, standard RS-232 protocol (via a computer) is accepted. When the switch is ON, the controller uses the PT-1 portable terminal protocol.

Switch 5: *Sets the parity setting.* The OFF setting selects 8 bit, no parity. The ON setting selects 7 bit, even parity.

Switch 4: *Sets the baud rate.* When OFF, the baud rate is 1200. When ON, the baud rate is 9600.

Switch 3: *Selects the end-of-line delimiter.* When the switch is OFF, the delimiter is a Carriage Return (CR). When the switch is ON, the delimiter is a Carriage Return Line Feed (CRLF).

Switch 2: *Controls the RS-232 compatibility for the set point value entry.* When the switch is OFF, the set point entry command is “S xxx.x.” When the switch is ON, the set point entry is “S1 xxx.x.” The extra “1” makes this entry downwardly compatible with other MKS products such as the Type 152, 153A, and 112 units.

Switch 1: *Selects the valve action.* The valve can be set to use either normal or reverse valve action; that is, the direction the valve uses for its open and closed positions.

Reverse: When the switch is OFF, the valve is open at 100% of its full scale position and closed at 0%. Pressure above the set point causes the valve to move toward the *open* position.

Normal: When the switch is ON, the valve is open at 0% of its full scale position and closed at 100%. Pressure above the set point causes the valve to move toward the *close* position.

How To Change the Dipswitch Settings

The dipswitches, located on the CPU board (refer to Figure 17, page 44), control the operating and communication parameters for the 153 controller. To set or change any of these parameters, you must change the position of the appropriate dipswitch.

Note

Refer to Table 10, page 45, for a complete listing of the functions assigned to each dipswitch and their initial settings.

To change the dipswitch settings:

1. Disconnect the power source from the 153 controller.

Warning

To avoid an electrical shock, disconnect the power cord *before* opening the unit.

2. Unscrew the two screws on the top of the unit and lift off the cover.
3. Locate the CPU board and the dipswitch bank.

There are two boards inside of the 153 unit; the CPU board is the small, top most board. Refer to Figure 17, page 44, for the location of the dipswitch bank.
4. Change the position of any of the dipswitches as required.

Refer to Table 10, page 45, for a complete listing of the functions assigned to each dipswitch and their initial settings.
5. Replace the cover of the unit and secure it in place with the two screws removed in step 2.
6. Power up the 153 controller.

Note

You must repower the system before any changes to the dipswitch setting are recognized by the 153 unit.

Power-Down Constants

The 153 unit saves the several constants in non-volatile memory (RAM) when the power is turned off. When the power is restored, the 153 unit “remembers” these settings.

The parameters saved in non-volatile memory are:

- Lead
- Gain
- Present valve position
- Analog set point zero (input)
- Analog set point full scale (input)
- Analog pressure zero (input)
- Analog pressure full scale (input)
- Number of valve steps
- Position zero (output)
- Position full scale (output)
- Pressure zero (output)
- Pressure full scale (output)

Power Up Conditions

The following conditions apply at power up:

- The processor checks the position of all switches on the dipswitch bank
- The operational mode is determined by dipswitches 7 and 8

If dipswitches 7 and 8 are ON, the unit “wakes up” in pressure control mode and uses an analog set point.

If dipswitches 7 and 8 are OFF, the unit “wakes up” in position control mode and uses a digital set point.

For more information on the operational modes, refer to *How To Select the Pressure Control Mode*, page 74, and *How To Select the Position Control Mode*, page 76.

- The stored constants are recalled and used in all subsequent operations

Labels

There are two labels on the 153 controller; a pump label and a serial number label. The labels are located on opposite sides of the 153 valve's driver/gear assembly (refer to Figure 3, page 23).

Pump Label

The pump label shown in Figure 18 indicates which side of the valve should be oriented towards the high vacuum pump during installation.

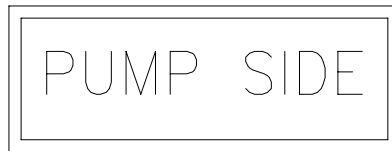

Figure 18: Pump Label

Serial Number Label

The serial number label lists the unit's serial number and the product model code, and displays the CE mark, signifying compliance with the European CE regulations.



Figure 19: Serial Number Label

The options for the 153 controller are identified in the model code when you order the unit. Refer to *Appendix B: Model Code Explanation*, page 95, for more information.

This page intentionally left blank.

Chapter Four: Operation

General Information

MKS products are designed and tested to provide the highest degree of safety attainable. To use your MKS valve safely, you must always conform to the following instructions:

Warning



The moving parts in the valve create a risk of personal injury until the valve is securely incorporated into a system. To avoid injury keep all objects away from any valve opening.

- Do not insert objects into openings where contact with moving parts is possible
- Isolate the equipment from any electrical or pneumatic power supply before handling the valve

Control Parameters

The initial control parameters for the 153 unit are listed in Table 11. To change any of these parameters, you must change the position of the appropriate dipswitch. Refer to *How To Change the Dipswitch Settings*, page 47, for more information.

Initial Control Parameters	
Parameter	Setting
Set Point Control Type	Pressure
Set Point Signal Type	Analog
Valve Action	Normal
Pressure Full Scale	+10 V
Set Point Full Scale	+10 V
Lead	4.0%
Gain	90.0%

Table 11: Initial Control Parameters

RS-232 Communication Parameters

The 153 controller can communicate with an external computer or a PT-1 portable terminal through the RS-232 interface. Using digital commands you can read the pressure, valve position, and the tuning parameters. You can also change the set point, open and close the valve, and adjust the tuning parameters. The initial RS-232 communication parameters for the 153 unit are listed in Table 12.

Note

Ensure that *both* your 153 controller and your computer are configured with the same communication parameters.

Initial RS-232 Communication Parameters	
Parameter	Setting
Baud Rate	9600
Data Bits*	8
Parity	None
Stop Bits*	1
Operating Protocol	PT-1 Portable RS-232 Terminal
End-of-Line Delimiter	Carriage Return (CR)
Handshaking*	None (off)
<i>* These parameters are factory set and cannot be adjusted.</i>	

Table 12: Initial RS-232 Communication Parameters

How To Change the Communication Parameters

To change any of the user-adjustable communication parameters, you must change the dipswitch settings on the CPU board. Refer to *How To Change the Dipswitch Settings*, page 47, for instructions on how to access the CPU board and change the dipswitch settings. The default dipswitch settings and their corresponding functions are listed in Table 10, page 45.

Note

When using the PT-1 unit, the 153 unit must be configured with the default dipswitch settings (refer to Table 10, page 45). When configured properly, the 153 unit accepts RS-232 characters from the PT-1 *without needing the shift key* on the portable terminal.

To change the communications parameters:

1. To use the PT-1 terminal protocol, leave switch 6 in the default ON position or switch it ON, if necessary.
To use the standard RS-232 protocol, flip switch 6 to the OFF position.
2. To use 8 bit no parity, leave switch 5 in the default OFF position or switch it OFF, if necessary.
To use 7 bit even parity, flip switch 5 to the ON position.
3. To use 9600 baud communications rate, leave switch 4 in the default ON position or switch it ON, if necessary.
To use 1200 baud communications rate, flip switch 5 to the OFF position.
4. To use a carriage return delimiter, leave switch 3 in the default OFF position or switch it OFF, if necessary.
To use a carriage return + line feed delimiter, flip switch 3 to the ON position.

Note

You must reboot the system before any changes to the dipswitch setting are recognized by the controller.

RS-232 Protocol

All RS-232 messages used by the 153 unit are composed of variable length ASCII strings. Messages sent to the unit from a remote computer or portable terminal are either *commands* that instruct the instrument to change an operating parameter, or *requests* that prompt the instrument to report information. Messages sent by the unit to a remote computer or portable terminal are *responses*. Responses either acknowledge a command issued by the host computer, or reply to a request sent by the host computer.

Message Format

Commands

The format of the commands sent to the 153 controller appear as:

command value

where **command** is a label that allows you to identify the command, and **value** identifies the task or parameter to be changed.

Requests

Requests (R) are numbered from 1 to 13, where each request has a different function, and appear as:

R #

Responses

Messages sent *by the 153 controller* to a remote computer are *responses*. Responses either acknowledge a command or reply to a request sent by the host computer.

The format of responses sent by the 153 controller to the computer appear as:

response value

where **response** is a label that allows you to identify the response, and **value** is the requested information.

Message Syntax

RS-232 message syntax uses the following conventions:

Note



1. Commands and requests are not case sensitive.
2. Spaces are included in the syntax for clarity only. Do not include spaces in actual commands.

bold

Commands that you must enter exactly as shown in the manual. Do not include any spaces in the message string.

italic

Placeholder representing text or numeric values that you must supply.

response

Information returned from the controller in response to a command or request.

ENTER

Represents the end-of-line delimiter. All messages must use a carriage return-line feed (CRLF) or carriage return (CR) as the end-of-line delimiter. Use your host computer's communications software to assign the desired action to the ENTER key. The 153 controller appends an end-of-line delimiter to the end of every response.

RS-232 Communication Commands

The RS-232 communication commands are separated into 3 functional groups: Operating Value, Valve Position, and Calibration. The communication commands are the same regardless of whether you are using a computer or the PT-1 portable terminal.

Note

Ensure that all of the dipswitch settings are properly configured (refer to Table 10, page 45) for your application. Dipswitch 6 must be OFF if you are using a computer, and ON if you are using the PT-1 portable terminal.

For each message, the following information is supplied:

- Description
- Command Message
- Request Message
- Response Message
- Factory Default Setting
(value set with the Reset [**B**] command)
- Non-Volatile Memory
(yes “Y”, stored in non-volatile RAM; or
no “N”, not stored in non-volatile RAM)

Note

The operating values stored in non-volatile RAM are saved when the power is turned off. When power is restored, the 153 controller “remembers” the latest configuration, not the default setting. To restore the various parameters to their factory default settings, you must use the Reset [**B**] command (refer to *How To Reset the Controller*, page 80, for more information).

Operating Value Messages

The Operating Value messages configure various operating parameters for your 153 controller.

RS-232 Operating Value Messages					
Description	Command	Request	Response	Factory Default Setting	Saved in Non-Volatile Memory
Lead	L value <i>value</i> = 0 to 100.0%	R3	L value <i>value</i> = 0 to 100.0%	4.0%	Y
Gain	G value <i>value</i> = 0 to 100.0%	R2	G value <i>value</i> = 0 to 100.0%	90%	Y
Set Point	S value or S1 value * <i>value</i> = 0 to 100.0%	R1	S value or S1 value* <i>value</i> = 0 to 100.0%	0.0%	N
<p><i>* The syntax for the set point command is either S or S1 (default), depending on the position of dipswitch 2 (refer to Table 10, page 45). The extra "1" makes this entry downwardly compatible with other MKS products such as the Type 152, 153A, and 112 units. Refer to How To Change the Dipswitch Settings, page 47, for more information.</i></p>					

Table 13: RS-232 Operating Value Messages

How To Set the Lead and Gain

Note

The procedure for how to adjust the lead and gain values is described in *How To Tune the Controller*, page 78.

How To Set the Lead

The command `[L value]` sets the lead value for the set point, where:

value: 0 to 100.0%

The default value is 4.0%. Refer to *Lead*, page 40, for more information.

To report the lead value, issue the request:

R3

The controller responds with the message `[L value]`, where:

value: 0 to 100.0%

How To Set the Gain

The command `[G value]` sets the gain value for the set point, where:

value: 0 to 100.0%

The default setting is 90%. Refer to *Gain*, page 41, for more information.

To report the gain value, issue the request:

R2

The controller responds with the message `[G value]`, where:

value: 0 to 100.0%

How To Set the Set Point

The command `[S value]` or `[S1 value]` sets the value for the set point, where:

value: 0 to 100.0%

The default setting is 0.0%. The syntax for the set point command is either S or S1 (default), depending on the position of dipswitch 2 (refer to Table 10, page 45). The extra “1” makes this entry downwardly compatible with other MKS products such as the Type 152, 153A, and 112 units. Refer to *How To Change the Dipswitch Settings*, page 47, for more information.

To report the value of the set point, issue the request:

R1

The controller responds with the message `[S value]` or `[S1 value]`, where:

value: 0 to 100.0%

Valve Position Messages

The Valve Position messages control the position and function of the throttle valve, allowing you to override normal operation.

Note



The Valve Position commands *override* the settings for dipswitch 8 (position versus pressure control) and dipswitch 7 (analog versus digital set point). In override mode, the controller moves the valve to the position requested by the commands listed in Table 14.

RS-232 Valve Position Messages					
Description	Command	Request	Response	Factory Default Setting	Saved in Non-Volatile Memory
Valve Open	O	none	none	none	---
Valve Close	C	none	none	none	---
Valve Hold	H	none	none	none	---
Valve Position	P <i>value</i> <i>value</i> = 0.0° (fully closed) to 90.0° (fully open)	R6	V <i>value</i> <i>value</i> = 0.0° (fully closed) to 90.0° (fully open)	none	Y
Return to Normal Operation	A (analog) D (digital)	none	none	none	---

Table 14: RS-232 Valve Position Messages

How To Control the Valve

The 153 unit can drive the throttle valve to full open or full close, or stop it at its current position. There are no requests associated with these functions.

Note



The RS-232 commands to open, close, or stop the valve override the active set point control of the valve.

After issuing a valve control command you must send either the [A] or [D] command to return the controller to normal analog or digital operation. Refer to *How To Return to Normal Operation*, page 61, for more information.

How to Drive the Valve to Full Open

To drive the valve to full open, issue the command:

O

How to Drive the Valve to Full Close

To drive the valve to full close, issue the command:

C

How to Stop the Valve

To stop (hold) the valve in its current position, issue the command:

H

How To Set the Valve Position

The command [P *value*] sets the valve position, where:

value: 0° to 90.0°

To report the valve position, issue the request:

R6

The controller responds with the message [V *value*], where:

value: 0° to 90.0°

How To Return to Normal Operation

The **O**, **C**, **H**, and **P value** commands override the normal operation of the valve. To return the controller to normal operation (as defined by the dipswitch settings listed in Table 10, page 45) after issuing a valve control command, send either of the following commands:

A

or

D

The controller exits from override mode and returns to the normal operating mode.

Calibration Messages

The 153 unit performs two types of calibrations:

- Learning System Characteristics (refer to Table 15)
- Calibrating for Output Errors (refer to Table 16, page 68)

How To Learn the System Characteristics

Learning the system characteristics sets the zero and full scale voltage levels for both the pressure and set point inputs, and sets the number of steps required for the throttle valve to move from its fully closed to fully open position.

RS-232 Learn Messages					
Description	Command	Request	Response	Factory Default Setting	Saved in Non-Volatile Memory
Learn Analog Set Point Zero	Z1	R10	Z A value value = 0 to 100% FS	0.0 V	Y
Learn Analog Set Point Full Scale	F1	R12	F value value = 0 to 100% FS	10.0 V	Y
Learn Analog Pressure Zero	Z2	R11	Z B value value = 0 to 100% FS	0.0 V	Y
Learn Analog Pressure Full Scale	F2	R13	F B value value = 0 to 100% FS	10.0 V	Y
Learn the Number of Valve Steps	V	none	none	none	Y

Table 15: RS-232 Learn Messages

How To Learn the Analog Set Point Zero

The command **[Z1]** instructs the controller to take the current value of the external analog set point for its zero value. Zeroing the analog set point allows you to correct any controller zero offsets. There is no request associated with this function.

To zero the analog set point:

1. Apply zero input voltage to pin 9 on the Input connector.
Refer to Table 7, page 33, for the Input connector pinout.
2. Enter the command:

Z1

The analog set point zero voltage is set to 0.0 V at the factory.

The actual voltage input to the unit must be measured. However, you can report the voltage input applied as a percentage of the full scale voltage range by using the **[R10]** command. To report the value of the analog set point zero as a percentage of the full scale voltage range, send the command:

R10

The controller responds with the message **[Z A value]**, where:

value: 0 to 100% FS

How To Learn the Analog Set Point Full Scale

The analog set point can be configured for 5 Volt or 10 Volt (default) full scale input. The voltage range is set with dipswitch 9 on the CPU board (refer to Table 10, page 45). You can, however, operate the 153 controller at a different full scale input, for example, 9.5 V, by recalibrating the full scale of the analog set point.

To calibrate the full scale of the analog set point:

1. Apply full scale input voltage (for example, 9.5 V) to pin 9 on the Input connector.

Refer to Table 7, page 33, for the Input connector pinout.

Before you proceed, ensure that the input voltage is at least 9% of the 10 V full scale voltage. If the voltage is less than 9% of the typical full scale voltage, the controller ignores the *Learn Analog Set Point Full Scale* command and retains the previous value. This eliminates the possibility of learning an erroneous voltage value.

2. Send the command:

F1

The 9.5 V input to the Interface connector is now the full scale value.

This command instructs the controller to assign the voltage applied in step 1 as the new full scale value for the analog set point, in this example, 9.5 V. This command also allows you to correct any full scale offsets.

The analog set point full scale voltage must be between +1 and +10.0 V. The analog set point full scale voltage is set to +10.0 V at the factory.

The actual voltage input to the unit must be measured. However, you can report the voltage input applied as a percentage of the full scale voltage range by using the **[R12]** command. To report the value of the analog set point full scale as a percentage of the full scale voltage range, send the command:

R12

The controller responds with the message `[F A value]`, where:*

value: 0 to 100% FS

For example, if the analog set point is configured for 10 V full scale input and the actual input applied is 10 V, the unit reports a value of 100%. However, if the actual input applied is 5.0 V, the unit reports a value of 50%.

How To Learn the Analog Pressure Zero

The command **[Z2]** zeros the base pressure in systems where the known base pressure is not *at*, but *near* zero (as measured by another transducer in the system). There is no request associated with this function.

To set the pressure zero:

1. Warm-up the transducer and pump it below its resolution.
2. Send the command:

Z2

The controller *learns* the pressure input that corresponds to the analog pressure zero value. The analog pressure zero value is factory set to 0.0 Volts.

Note

If the pressure reading (at base pressure) is greater than 4% of full range, the sensor will not be zeroed.

The actual voltage input to the unit must be measured. However, you can report the voltage input applied as a percentage of the full scale voltage range by using the **[R11]** command. To report the value of the pressure zero as a percentage of the full scale voltage range, send the command:

R11

The controller responds with the message **[Z B value]**, where:

value: 0 to 100% FS

Note

When a voltage enters the controller as a calibration signal, for a pressure zero reading, the controller scales the signal to allow for a slightly overrange or underrange signal. The controller does not convert the signal back to a full 0 to 10 V range.

Therefore, when you query the controller for a pressure zero reading using the **[R11]** request, it returns the offset value, rather than the true zero voltage reading.

How To Learn the Analog Pressure Full Scale

1. Warm-up the transducer and set up the pressure system for full scale pressure.
2. Send the command:

F2

The controller raises the pressure to the full scale value of the transducer and learns the pressure input that corresponds to the analog pressure full scale value. The analog pressure full scale value is factory set to +10.0 Volts.

Note



If a transducer is *not* connected to your system, apply full scale input voltage to pin 20 on the Input connector before sending the **[F2]** command.

Refer to Table 7, page 33, for the Input connector pinout. Ensure that the pressure input voltage on Input connector, pin 20, is at least 9% of the 10 V full scale voltage. If the voltage is less than 9% of the typical full scale voltage, the controller ignores the learn command and retains the previous value. This eliminates the possibility of learning an erroneous voltage value.

The actual voltage input to the unit must be measured. However, you can report the voltage input applied as a percentage of the full scale voltage range by using the **[R13]** command. To report the value of the pressure full scale as a percentage of the full scale voltage range, send the command:

R13

The controller responds with the message **[F B value]**, where:

value: 0 to 100% FS

Note



When a voltage enters the controller as a calibration signal, for a pressure full scale reading, the controller scales the signal to allow for a slightly overrange or underrange signal. The controller does not convert the signal back to a full 0 to 10 V range.

Therefore, when you query the controller for a pressure full scale reading using the **[R13]** request, it returns the offset value, rather than the true full scale voltage reading.

How To Learn the Number of Valve Steps

Caution

The procedure for learning the valve steps involves opening and closing the valve. Be certain that the system can withstand valve cycling before proceeding.

The **[V]** command sets or *learns* the number of steps required for the throttle valve to move from its fully closed (0) to fully open (100) position. There is no request associated with this command.

To learn the number of valve steps, send the command:

V

How To Calibrate the System for Output Errors

The Calibration for Output Error commands adjust the digital signal outputs from the 153 controller. The unit produces the pressure output on pin 4 and the position output on pin 6 of the Input connector (refer to Table 7, page 33). The default range for the output voltage is 0 to 10 V. However, you can switch the range to 0 to 5 V by changing the position of dipswitch 9 (refer to Table 10, page 45).

The 153 controller can perform the following calibrations in order to adjust the output for errors:

- Calibrate the zero and full scale analog output for position control
- Calibrate the zero and full scale analog output for pressure control

Note



You must issue these commands using RS-232 communications. To do this, connect a computer or a PT-1 portable terminal to the controller. Refer to *Chapter Two: Installation*, page 19, for more information.

In addition, you must connect a digital voltmeter to the controller's Input connector, as described in the calibration procedures on pages 70 and 71.

RS-232 Calibration for Output Error Messages					
Description	Command	Request	Response	Factory Default Setting	Saved in Non-Volatile Memory
Set Position Output to Zero	Q3Z	none	none	none	Y
Calibrate Position Zero Analog Output	Z3 <i>voltage</i>	none	none	none	Y
Set Position Output to Full Scale	Q3F	none	none	none	Y
Calibrate Position Full Scale Analog Output	F3 <i>voltage</i>	none	none	none	Y
Release Unit from Position Output Calibration	Q3R	none	none	---	---

Table 16: RS-232 Calibration for Output Error Messages
(Continued on next page)

RS-232 Calibration for Output Error Messages (Continued)					
Description	Command	Request	Response	Factory Default Setting	Saved in Non-Volatile Memory
Set Pressure Output to Zero	Q4Z	none	none	none	Y
Calibrate Pressure Zero Analog Output	Z4 <i>voltage</i>	none	none	none	Y
Set Pressure Output to Full Scale	Q4F	none	none	none	Y
Calibrate Pressure Full Scale Analog Output	F4 <i>voltage</i>	none	none	none	Y
Releases Unit from Pressure Output Calibration	Q4R	none	none	---	---

Table 16: RS-232 Calibration for Output Error Messages

How To Calibrate the Zero and Full Scale Output for Position Control

1. Set the position output to zero by sending the command:

Q3Z

2. Read the position output voltage on pin 6 on the Input connector using a digital voltmeter.

Take note of this value; you must enter it as *voltage* in step 3. Refer to Table 7, page 33, for the Input connector pinout.

3. Enter the position output voltage reading from step 2 as *voltage*, by sending the command:

Z3 *voltage*

The controller calibrates the position output zero. The first character of *voltage* must be a + or - sign followed by the numeric reading obtained in step 2. For example, +0.054 or -0.06 are valid entries for *voltage*.

4. Set the position output to full scale by sending the command:

Q3F

5. Read the position output voltage on pin 1 on the Input connector using a digital voltmeter.

Take note of this value; you must enter it as *voltage* in step 6. Refer to Table 7, page 33, for the Input connector pinout.

6. Enter the position output voltage reading from step 5 as *voltage*, by sending the command:

F3 *voltage*

The controller calibrates the position output full scale. The first character of *voltage* must be a + or - sign followed by the numeric reading obtained in step 5. For example, +9.054 or +10.06 are valid entries for *voltage*.

7. Exit the calibration procedure and return to normal operation by sending the command:

Q3R

How To Calibrate the Zero and Full Scale Output for Pressure Control

1. Set the pressure output to zero by sending the command:

Q4Z

2. Read the pressure output voltage on pin 4 on the Input connector using a digital voltmeter.

Take note of this value; you must enter it as *voltage* in step 3. Refer to Table 7, page 33, for the Input connector pinout.

3. Enter the pressure output voltage reading from step 2 as *voltage*, by sending the command:

Z4 *voltage*

The controller calibrates the pressure output zero. The first character of *voltage* must be a + or - sign followed by the numeric reading obtained in step 2. For example, +0.054 or -0.06 are valid entries for *voltage*.

4. Set the pressure output to full scale by sending the command:

Q4F

5. Read the pressure output voltage on pin 4 on the Input connector using a digital voltmeter.

Take note of this value; you must enter it as *voltage* in step 6. Refer to Table 7, page 33, for the Input connector pinout.

6. Enter the pressure output voltage reading from step 5 as *voltage*, by sending the command:

F4 *voltage*

The controller calibrates the pressure output full scale. The first character of *voltage* must be a + or - sign followed by the numeric reading obtained in step 5. For example, +9.054 or +10.06 are valid entries for *voltage*.

7. Exit the calibration procedure and return to normal operation by sending the command:

Q4R

Informational Messages

Informational messages report data on the 153 controller. There are no commands associated with these functions.

RS-232 Informational Messages		
Description	Request	Response
Pressure Reading • reports system pressure as % FS	R 5	<i>P value</i> <i>value: 0 to 100.0% FS</i>
Analog Set Point Input Voltage • reports the actual input voltage as a % of the analog set point FS voltage range	R 4	<i>A value</i> <i>value: voltage as a % of the analog set point FS voltage range</i>
Valve Slipped Signal • reports the status of the valve slipped signal	R 8	<i>C x</i> <i>x: 0 = Valve not slipped</i> <i>1 = Valve slipped</i>

Table 17: RS-232 Informational Messages

How To Report the Pressure Reading

To report the pressure reading as a percentage (%) of full scale (FS) of your pressure sensor, issue the request:

R 5

The controller responds with the message [*P value*], where:

value: 0 to 100.0 % of sensor full scale

How To Calculate the Absolute Pressure

Calculate the absolute pressure using the formula:

$$\text{ABSOLUTE PRESSURE} = (\text{P value} / 100) \times (\text{Full Scale})$$

For example, if the pressure reading (*P value*) for a 1000 Torr FS unit was reported as 65 (65%), the absolute pressure is:

$$\text{ABSOLUTE PRESSURE} = (65 / 100) \times (1000) = 650 \text{ Torr}$$

How To Report the Analog Set Point Input Voltage

To report the actual input voltage as a percent of the analog set point full scale voltage range, enter:

R 4

The controller responds with the message [A *value*], where:

value: % of the analog set point FS voltage range

Note



The request [R 4] reports the analog set point value as *a percentage of the analog set point full scale range*; it does not report the percentage of the controlling transducer's range.

How To Report the Status of the Valve Slipped Signal

To report the status of the valve slipped signal, issue the command:

R 8

The controller responds with the message:

C *x*

where *x*: 0 = Valve not slipped
1 = Valve slipped

Note



If the valve slipped signal is set to "1", the valve must be re-calibrated. Refer *How To Reset the Controller*, page 80, for more information.

How To Use the Pressure Control Mode

How To Select the Pressure Control Mode

To select the pressure control mode:

1. Place switch 8 in the dipswitch bank to the ON (Closed) position.
This is the default setting for switch 8.
2. Verify that pin 15 on the Input connector is high (default).
Refer to Table 7, page 33, for the Input connector pinout. If pin 15 is low, it overrides the switch 8 setting in step 1.
3. Send the controller an analog or digital set point.

How To Use an Analog Set Point for Pressure Control

To use an analog set point:

1. Place switch 7 in the dipswitch bank to the ON (Closed) position.
This is the default setting for switch 7.
2. Supply a voltage to pin 9 on the Input connector.
Refer to Table 7, page 33, for the Input connector pinout. The set point is expressed as a percent of full scale pressure, where:

$$\text{set point} = \frac{\text{analog set point voltage on pin 9}}{\text{analog set point full scale voltage}}$$

For example, if the analog set point full scale voltage is 10 Volts and you supply a set point voltage of 5 Volts, you are establishing a set point of 50% of full scale pressure.

Note

Even if you are using an analog set point, you must connect a computer or PT-1 unit to the controller in order to calibrate and tune the controller, and learn the valve. The analog set point zero and full scale voltages are calibrated using the procedures described in *How To Learn the System Characteristics*, page 62.

How To Use a Digital Set Point for Pressure Control

To use a digital set point:

1. Place switch 7 in the dipswitch bank to the OFF (Open) position.
This is *not* the default setting for switch 7.
2. Connect the controller to a computer or PT-1 unit.
Refer to *Chapter Two: Installation*, page 19, for more information.
3. Send the RS-232 Pressure Set Point command (refer to Table 13, page 57):

S1 value

where *value* is a percent value representing the pressure set point as a percent of full scale pressure. For example, to send a pressure set point of 25% of full scale pressure, send the command:

S1 25

How To Override the Pressure Control Mode

Even though you are using the 153 unit as a pressure controller, there may be times when you want to temporarily suspend the Pressure Control mode and move the valve to a specific position.

To override the Pressure Control mode:

1. Ensure that the controller is connected to a computer or PT-1 unit.
Refer to *Chapter Two: Installation*, page 19, for more information.
2. Send the unit the appropriate Valve Position command.
The RS-232 Valve Position commands are listed in Table 14, page 59.
3. Send the [A] or [D] command to return operation to either the analog or digital Pressure Control mode.

How To Use the Position Control Mode

How To Select the Position Control Mode

To select the position control mode:

1. Place switch 8 in the dipswitch bank to the OFF (Open) position.

This is *not* the default setting for switch 8. Alternately, you can leave switch 8 in the default ON (Closed) position and pull pin 15 low on the Input connector. If pin 15 is low, it will override the switch 8 setting. Refer to Table 7, page 33, for the Input connector pinout.

2. Send the controller an analog or digital set point.

How To Use an Analog Set Point for Position Control

To use an analog set point:

1. Place switch 7 in the dipswitch bank to the ON (Closed) position.

This is the default setting for switch 7.

2. Supply a voltage to pin 9 on the Input connector.

Refer to Table 7, page 33, for the Input connector pinout. The set point is expressed as a percent of full scale position, where:

$$\text{set point} = \frac{\text{analog set point voltage on pin 9}}{\text{analog set point full scale voltage}}$$

For example, if the analog set point full scale voltage is 10 Volts and you supply a set point voltage of 5 Volts, you are establishing a set point of 50% of full open or 45°.

How To Use a Digital Set Point for Position Control

To use a digital set point:

1. Connect the controller to a computer or the PT-1 portable terminal.
Refer to *Chapter Two: Installation*, page 19, for more information.
2. Place switch 7 in the dipswitch bank to the OFF (Open) position.
This is *not* the default setting for switch 7.
3. Send the RS-232 Position Set Point command (refer to Table 14, page 59):

P value

where *value* is the position in degrees. The acceptable input range is 0 (fully closed) to 90 (fully open). For example, to send a position set point of half open (45 degrees), send the command:

P 45

Note

Sending the [**P value**] command overrides the Pressure Control mode. Refer to *How To Override the Pressure Control Mode*, page 75, for more information.

How To Tune the Controller

The 153 controller is tuned by adjusting the lead and gain parameters with the RS-232 commands listed in Table 13, page 57.

Note

The “optimal” lead and gain settings result in the best response when the pressure is near the set point. That is, when there is minimal overshoot and no oscillation. Refer to *Lead and Gain*, page 39, for additional information.

To tune the controller:

1. Apply power to the unit and turn on the upstream gas source(s).
2. Apply the desired analog set point signal or RS-232 message.

The unit responds by changing the pressure smoothly to the desired value. If the pressure is slow changing to the desired value (over 30 seconds), or oscillates, then adjust the lead and/or gain values.

3. Start with a high gain setting; however, *do not* adjust the value at this time.

The gain value depends on the process being controlled. The acceptable input range is 0 to 100%; the default value is 90.0%.

4. Adjust the lead setting.

- If the pressure overshoots the set point, *increase* the lead setting.
- If there is no overshoot, and particularly if the pressure is slow approaching the set point, then *reduce* the lead setting.

The acceptable input range is 0 to 100%; the default value is 4.0%.

5. Repeat step 4 to confirm that the lead setting is appropriate.

Note

The correct lead setting for a rise in pressure is normally *not* the same for a drop in pressure. Therefore, adjust the lead parameter using the same set point and direction as required in your process.

6. Reduce the gain setting.

Only adjust the gain setting if the pressure continues to oscillate around the set point, and it cannot be corrected by adjusting the lead.

Note



The highest possible gain setting produces the best pressure control, therefore, reduce the gain setting in very small increments.

The speed of pressure response is relative and depends on chamber size and absolute pressure. Lower pressures (less than 10 microns) are usually slower because of the slower molecular flow and reduced pumping speed.

The maximum rate of rise of pressure is determined by the following formula (with the exhaust valve fully closed):

$$Pr = F/V$$

where: Pr = pressure rate of rise in Torr/sec.
F = flow in Torr-liters/sec.
V = volume in liters.

Consequently, in systems with small input flows and relatively large volumes, the pressure will rise slowly even when the control valve is fully closed.

If the controller cannot achieve good control, the problem may be caused by improper pneumatic connections. Refer to *System Configuration*, page 30, for more information about factors which effect pressure control.

How To Reset the Controller

The reset function enables the 153 controller to identify important characteristics for system control. Use the learn function whenever the 153 unit is used in a new vacuum system or when processing conditions are changed (such as changed flow rate, new or refurbished pump, or piping modifications). *The learning process may take several minutes to complete.*

Caution



The procedure for learning the controller causes the valve to move to its fully open and fully closed positions. Be certain that your system can withstand valve cycling before issuing the [B] command.

The operating parameters are reset with the [B] command, as listed in Table 18:

Settings Established by the Reset [B] Command	
Parameter	Value
Lead	4.0%
Gain	90.0%
Pressure Set Point	0.0%
Pressure Zero	0.0 Volts
Set Point Zero	0.0 Volts
Pressure Full Scale	10.0 Volts (reported as a % of FS)
Set Point Full Scale	10.0 Volts (reported as a % of FS)

Table 18: Settings Established by the Reset [B] Command

To reset the controller:

1. Initiate the proper gas flow into the system.

The gas flow rate should be close to that used for the actual process (use the maximum flow rate if several flow rates are used in the process). Do not vary the gas flow rate during learning.

Note

The system pressure will vary during the learn cycle to as low and high as is possible for the current flow rate.

2. Send the command:

B

The command resets the controller, re-learns the valve, and resets the values for the lead, gain, set point, and the zero and full scale voltage levels for both the pressure and set point inputs to the values listed in Table 18, page 80.

You may need to reset the lead, gain, zero, and full scale values to those used prior to resetting the controller. To reset the lead and gain values, refer to *How To Tune the Controller*, page 78. To reset the set point, refer to *How To Set the Set Point*, page 58. To reset the zero and full scale settings, refer to *How To Learn the System Characteristics*, page 62.

This page intentionally left blank.

Chapter Five: Maintenance and Troubleshooting

General Information

If your controller fails to operate properly upon receipt, check for shipping damage, and check the power/signal cable for proper continuity. Any damage should be reported to the carrier and MKS Instruments immediately. If there is no obvious damage and the continuity is correct, obtain an ERA Number (Equipment Return Authorization Number) before returning the unit to MKS Instruments for service.

Note

MKS recommends that the zero adjustment be the only adjustment made in the field. Return the transducer to MKS Instruments for other adjustments, calibrations, or servicing.

Maintenance

In general, no maintenance is required other than proper installation and operation, and an occasional zero adjustment. Periodically check for wear on the cables and inspect the enclosure for visible signs of damage.

How To Clean the Unit

Periodically wipe down the unit with a damp cloth.

Troubleshooting

Valve Slipped Signal

The 153 unit has a “valve slipped” signal that can be useful when diagnosing exhaust valve or system problems. The valve slipped signal is only available through the RS-232 interface.

When the 153 unit contacts either of the limit switches, the internal position signal should equal the appropriate valve position (0 for close, 100% for open). If the position signal is more than 3% different from the appropriate value, the valve slipped signal is set to “1” (meaning slipped).

When the request **R8** is sent to the 153 unit, the unit returns either “C0” or “C1” (refer to Table 17, page 72). The response “C0” indicates the valve has not slipped. The response “C1” indicates the valve has slipped *since the last time the request was issued*. The signal is reset to 0 when it is read by the computer or PT-1 unit.

Situations that can cause the valve to slip include:

- The flapper is moved while the 153 unit is turned off
- The flapper is rubbing or contacting part of the plumbing
- Particulates are depositing on the wall and slowing the flapper motion

Appendix A: Product Specifications

Valve Specifications

Ambient Operating Temperature	15° to 50° C (59° to 122° F)
CE Compliance Electromagnetic Compatibility ¹ Machinery	EMC Directive 89/336/EEC Machinery Directive 89/392/EEC
Connectors Input (J1) Power (J2)	25-Pin Female Type “D” 9-Pin Male Type “D”
Control Lines	OPEN and CLOSE Valve control lines (Activated by an active low TTL) Hi input maximum voltage is 30 Volts and drawing less than 200 µA of leakage current
Display	1 Red LED for OPEN Limit Switch 1 Red LED for CLOSE Limit Switch 1 Green LED for Power
Input Power Requirements (minimum)	+15 VDC to maximum +30 VDC @ less than 6 Watts If a transducer is connected to the unit, its power can be supplied by the same external supply used by the 153 unit, or by a separate external supply.
Manual Valve Switch	Toggle switch directs valve to OPEN or CLOSE position The Normal/Hold switch toggles the valve between normal operation and hold operation which holds the valve in position
Outputs	Opto-coupled Limit Switch (LS) One for Open, one for Close 30 V maximum, 10 mA maximum

¹An overall metal braided shielded cable, properly grounded at both ends, is required during use.

Position Output Signal	0 to +10 VDC (normally), switchable to 0 to +5 VDC Can be calibrated to adjust for output error (refer to <i>How To Calibrate the System for Output Errors</i> , page 68)
Power Loss	Unit saves calibration constants and valve position (refer to <i>Power-Down Constants</i> , page 48)
Pressure Input Signal	0 to +10 Volts DC (normally) Can be calibrated to any full scale voltage from 1 to 10 Volts
Pressure Output Signal	0 to +10 VDC (normally), switchable to 0 to +5 VDC Can be calibrated to adjust for output error (refer to <i>How To Calibrate the System for Output Errors</i> , page 68)
RS-232 Communication	Bi-directional communication Input - set point and learn commands (in 0.1% increments) Output - (on request) actual position, pressure (in 0.1% increments) “Out of Sync” - Valve Slipped
Set Point Input Signal	0 to +10 Volts DC (normally) Can be calibrated to any full scale voltage from 1 to 10 Volts
Valve Speed - OPEN to CLOSE	Normal - 7.5 seconds Fast - 1.8 seconds (Ref SP021-84)

Due to continuing research and development activities, these product specifications are subject to change without notice.

ASA Flange Specifications

Valve Type Number	153E-2-2-1	153E-2-2-2	153E-60-2-2	153E-3-2-1	153E-3-2-2	153E-3-3-1	153B-3-3-2	153E-4-3-1
Inside Diameter (A)* Inches (mm)	1.88 (47.8)	1.950 (49.5)	2.362 (60.0)	2.888 (73.4)	3.025 (76.8)	2.888 (73.4)	3.025 (76.8)	3.888 (98.8)
Mounting Flange	ASA 2"	ASA 2"	ASA 2"	ASA 2"	ASA 2"	ASA 3"	ASA 3"	ASA 3"
Outside Diameter (B)* Inches (mm)	5.95 (151)	5.95 (151)	5.95 (151)	5.95 (151)	5.95 (151)	7.40 (188)	7.40 (188)	7.40 (188)
Controllable Conductance (I/sec) min max	0.35 300	0.70 300	0.80 375	1.00 500	1.00 500	1.00 500	1.00 500	1.50 950
Closed Leakage (Torr I/sec)	$<10^{-7}$	N/A	N/A	N/A	N/A	N/A	N/A	N/A
Flapper Seal**	Viton	None	None	None	None	None	None	None
Thickness (D)* Inches (mm)	0.75 (19.1)	0.75 (19.1)	0.75 (19.1)	0.75 (19.1)	0.75 (19.1)	0.88 (22.4)	0.88 (22.4)	0.88 (22.4)
Bolt Hole Diameter (E)* Inches (mm)	0.75 (19.1)	0.75 (19.1)	0.75 (19.1)	0.75 (19.1)	0.75 (19.1)	0.75 (19.1)	0.75 (19.1)	0.75 (19.1)
No. of Bolt Holes (F)	4	4	4	4	4	4	4	4
Bolt Circle Diameter (G) Inches (mm)	4.750 (120.7)	4.750 (120.7)	4.750 (120.7)	4.750 (120.7)	4.750 (120.7)	6.000 (152.4)	6.000 (152.4)	6.000 (152.4)
Bolt Hole Offset Angle (H)	45°	45°	45°	45°	45°	45°	45°	45°
Flange O-ring Groove ID (J) In (mm) Parker® No. or Size (JIS)	3.365 (85.5) 2-237	3.365 (85.5) 2-237	3.365 (85.5) 2-237	3.365 (85.5) 2-237	3.365 (85.5) 2-237	4.475 (113.7) 2-349	4.475 (113.7) 2-349	4.475 (113.7) 2-349
Overall Height Inches (mm)	12.72 (323.1)	12.72 (323.1)	12.72 (323.1)	12.72 (323.1)	12.72 (323.1)	14.17 (359.9)	14.17 (359.9)	14.17 (359.9)

(Continued on next page)

ASA Flange Specifications (Continued)

Valve Type Number	153E-4-3-2	153E-4-4-1	153E-4-4-2	153E-6-4-2	153E-6-6-2	153E-8-6-2	153E-8-8-2	153E-10-10-2
Inside Diameter (A)* Inches (mm)	3.965 (100.7)	3.888 (98.8)	3.965 (100.7)	5.781 (146.8)	5.781 (146.8)	7.501 (190.5)	7.501 (190.5)	10.000 (254.0)
Mounting Flange	ASA 3"	ASA 4"	ASA 4"	ASA 4"	ASA 6"	ASA 6"	ASA 8"	ASA 10"
Outside Diameter (B)* Inches (mm)	7.40 (188)	8.90 (226.1)	8.90 (226.1)	8.90 (226.1)	10.90 (276.9)	10.90 (276.9)	13.19 (335.0)	16.00 (406.4)
Controllable Conductance (I/sec) min max	1.50 950	1.50 950	1.50 950	TBD TBD	TBD TBD	TBD TBD	TBD TBD	TBD TBD
Closed Leakage (Torr I/sec)	N/A	N/A	N/A	N/A	N/A	N/A	N/A	N/A
Flapper Seal**	None	None	None	None	None	None	None	None
Thickness (D)* Inches (mm)	0.88 (22.4)	0.88 (22.4)	0.88 (22.4)	0.88 (22.4)	0.94 (23.9)	0.94 (23.9)	0.94 (23.9)	0.94 (23.9)
Bolt Hole Diameter (E)* Inches (mm)	0.75 (19.1)	0.75 (19.1)	0.75 (19.1)	0.75 (19.1)	0.88 (22.4)	0.88 (22.4)	0.88 (22.4)	1.00 (25.4)
No. of Bolt Holes (F)	4	8	8	8	8	8	8	12
Bolt Circle Diameter (G) Inches (mm)	6.000 (152.4)	7.500 (190.9)	7.500 (190.9)	7.500 (190.9)	9.500 (241.3)	9.500 (241.3)	11.750 (298.5)	14.250 (362.0)
Bolt Hole Offset Angle (H)	45°	22.5°	22.5°	22.5°	22.5°	22.5°	22.5°	15°
Flange O-ring Groove ID (J) In (mm) Parker® No. or Size (JIS)	4.475 (113.7) 2-349	5.995 (152.3) 2-258	5.995 (152.3) 2-258	5.995 (152.3) 2-258	8.000 (203.2) 2-266	8.000 (203.2) 2-266	9.734 (247.2) 2-273	11.938 (303.2) 2-278
Overall Height Inches (mm)	14.17 (359.9)	15.67 (398.0)	15.67 (398.0)	15.67 (398.0)	17.67 (448.8)	17.67 (448.8)	19.96 (507)	22.77 (578.4)
<p>*Refer to Figure 4, page 24. **Where Viton is used, other materials are available; consult the factory.</p>								

KF Style ISO Flange Specifications

Valve Type Number	153E-20-40-1	153E-20-40-2	153E-1-40-1	153E-1-40-2	153E-2-50-1	153E-2-50-2
Inside Diameter (A₁)* Inches (mm)	0.870 (22.1)	0.870 (22.1)	1.385 (35.2)	1.385 (35.2)	2.000 (50.8)	N/A
Inside Diameter (A₂)* Inches (mm)	0.779 (19.8)	0.779 (19.8)	1.270 (32.3)	1.270 (32.3)	1.888 (48.0)	N/A
Inside Diameter (A)* Inches (mm)	N/A	N/A	N/A	N/A	N/A	2.000 (50.8)
Mounting Flange (F)	KF-40	KF-40	KF-40	KF-40	KF-50	KF-50
Outside Diameter (B)* Unheated Inches (mm)	2.75 (69.9)	2.75 (69.9)	2.75 (69.9)	2.75 (69.9)	3.25 (82.6)	3.25 (82.6)
With heater option Inches (mm)	3.00 (76.2)	3.00 (76.2)	3.00 (76.2)	3.00 (76.2)	3.50 (88.9)	3.50 (88.9)
Controllable Conductance (l/sec) min max	0.07 24	0.25 31	0.20 50	0.40 55	0.35 300	0.70 300
Closed Leakage (Torr l/sec)	<10 ⁻⁷	N/A	<10 ⁻⁷	N/A	<10 ⁻⁷	N/A
Flapper Seal**	Viton	None	Viton	None	Viton	None
Outside Flange Width (C)* Inches (mm)	2.16 (54.9)	2.16 (54.9)	2.16 (54.9)	2.16 (54.9)	2.95 (74.9)	2.95 (74.9)
Thickness (D)* Inches (mm)	1.25 (31.8)	1.25 (31.8)	1.25 (31.8)	1.25 (31.8)	1.00 (25.4)	1.00 (25.4)
Outside Flange Width (E)* Inches (mm)	2.25 (57.2)	2.25 (57.2)	2.25 (57.2)	2.25 (57.2)	2.00 (50.8)	2.00 (50.8)

(Continued on next page)

KF Style ISO Flange Specifications (Continued)

Valve Type Number	153E-20-40-1	153E-20-40-2	153E-1-40-1	153E-1-40-2	153E-2-50-1	153E-2-50-2
Overall Height						
Unheated						
Inches	10.57	10.57	10.57	10.57	11.07	11.07
(mm)	(268.5)	(268.5)	(268.5)	(268.5)	(281.2)	(281.2)
With heater option						
Inches	10.82	10.82	10.82	10.82	11.32	1.32
(mm)	(274.8)	(274.8)	(274.8)	(274.8)	(287.5)	(287.5)
<i>*Refer to Figure 5, page 25.</i> <i>**Where Viton is used, other materials are available; consult factory.</i>						

NW Style ISO Flange Specifications

Valve Type Number	153E-60-63-2	153E-3-80-1	153E-3-80-2	153E-4-100-1	153E-4-100-2	153E-6-160-2	153E-8-200-2	153E-10-250-2
Inside Diameter (A)* Inches (mm)	2.362 (60.0)	2.888 (73.4)	3.000 (76.2)	3.888 (98.8)	3.875 (98.4)	5.750 (146.1)	7.650 (194.3)	9.700 (246.4)
Mounting Flange	NW-63	NW-80	NW-80	NW-100	NW-100	NW-160	NW-200	NW-250
Outside Diameter (B)* Inches (mm)	5.95 (151.1)	5.95 (151.1)	5.95 (151.1)	7.40 (188)	7.40 (188.0)	8.90 (226.1)	11.22 (285.0)	13.19 (335.0)
Controllable Conductance (I/sec) min max	0.80 375		1.00 500		1.50 900	TBD TBD	TBD TBD	TBD TBD
Closed Leakage (Torr I/sec)	N/A		N/A		N/A	N/A	N/A	N/A
Flapper Seal**	None		None		None	None	None	None
Thickness (D)* Inches (mm)	0.81 (20.6)	0.81 (20.6)	0.81 (20.6)	1.00 (25.4)	0.94 (23.9)	0.94 (23.9)	0.94 (23.9)	0.94 (23.9)
Bolt Hole Diameter (E)* Inches (mm)	0.35 (8.89)	0.35 (8.89)	0.35 (8.89)	0.35 (8.89)	0.35 (8.89)	0.43 (10.9)	0.43 (10.9)	0.43 (10.9)
No. of Bolt Holes (F)	4	8	8	8	8	8	12	12
Bolt Circle Diameter (G) Inches (mm)	4.330 (110.0)	4.920 (125.0)	4.920 (125.0)	5.710 (145)	5.710 (145.0)	7.870 (199.9)	10.240 (260.1)	12.200 (309.9)
Bolt Hole Offset Angle (H)	45°	22.5°	22.5°	22.5°	22.5°	22.5°	15°	15°
Overall Height Inches (mm)	12.72 (323.1)	12.72 (323.1)	12.72 (323.1)	14.17 (359.9)	14.17 (359.9)	15.67 (398.0)	17.99 (456.9)	19.96 (507)
*Refer to Figure 6, page 26. **Where Viton is used, other materials are available; consult factory.								

CF Flange Specifications

Valve Type Number	153E-20-2CF-1	153E-20-2CF-2	153E-1-2CF-1	153E-1-2CF-2	153E-2-3CF-1	153E-2-3CF-2	153E-2-4CF-1
Inside Diameter (A)* Inches (mm)	0.779 (19.79)	0.779 (19.79)	1.270 (32.3)	1.270 (32.3)	1.888 (48.0)	2.000 (50.8)	1.888 (48.0)
Mounting Flange	2¼" CF	2¼" CF	2¼" CF	2¼" CF	3¾" CF	3¾" CF	4½" CF
Outside Diameter (B)* Inches (mm)	2.75 (69.9)	2.75 (69.9)	2.75 (69.9)	2.75 (69.9)	3.25 (82.6)	3.25 (82.6)	4.47 (113.5)
Controllable Conductance (I/sec) min max	0.07 24	0.25 31	0.20 50	0.40 55	0.35 300	0.35 300	TBD TBD
Closed Leakage (Torr I/sec)	<10 ⁻⁷	N/A	<10 ⁻⁷	N/A	<10 ⁻⁷	<10 ⁻⁷	<10 ⁻⁷
Flapper Seal**	Viton	None	Viton	None	Viton	None	Viton
Valve Adapter (C)* Inches (mm)	1.44 (36.6)	1.44 (36.6)	1.44 (36.6)	1.44 (36.6)	1.44 (36.6)	1.44 (36.6)	1.44 (36.6)
Thickness (D)* Inches (mm)	1.25 (31.8)	1.25 (31.8)	1.25 (31.8)	1.25 (31.8)	1.06 (26.9)	1.06 (26.9)	1.00 (25.4)
Bolt Hole Diameter (E)* Inches (mm)	0.26 (6.60)	0.26 (6.60)	0.26 (6.60)	0.26 (6.60)	0.33 (8.38)	0.33 (8.38)	0.33 (8.38)
No. of Bolt Holes (F)	6	6	6	6	8	8	8
Bolt Circle Diameter (G) Inches (mm)	2.312 (58.7)	2.312 (58.7)	2.312 (58.7)	2.312 (58.7)	2.850 (72.4)	2.850 (72.4)	3.628 (92.2)
Bolt Hole Offset Angle (H)	30°	30°	30°	30°	22° 30'	22° 30'	22° 30'
Overall Height Inches (mm)	10.57 (268.5)	10.57 (268.5)	10.57 (268.5)	10.57 (268.5)	11.07 (281.2)	11.07 (281.2)	12.29 (312.2)

(Continued on next page)

CF Flange Specifications (Continued)

Valve Type Number	153E 2-4CF-2	153E 3-6CF-1	153E 3-6CF-2	153E 4-6CF-1	153E 4-6CF-2	153E 6-8CF-1	153E 8-10CF-2
Inside Diameter (A)* Inches (mm)	2.000 (50.8)	2.888 (73.4)	3.000 (76.2)	3.888 (98.8)	3.875 (98.4)	5.750 (146.1)	7.650 (194.3)
Mounting Flange	4½" CF	6" CF	6" CF	6" CF	6" CF	8" CF	10" CF
Outside Diameter (B)* Inches (mm)	4.47 (113.5)	7.40 (188.0)	7.40 (188.0)	7.40 (188.0)	7.40 (188.0)	8.90 (226.1)	11.22 (285)
Controllable Conductance (I/sec) min max	0.70 300	1.00 500	1.00 500	1.00 500	1.50 900		
Closed Leakage (Torr I/sec)	N/A	N/A	N/A	N/A	N/A		
Flapper Seal**	None	None	None	None	None		
Valve Adapter (C)* Inches (mm)	1.44 (36.6)	0.39 (9.91)	0.39 (9.91)	0.39 (9.91)	0.39 (9.91)	0.39 (9.91)	0.39 (9.91)
Thickness (D)* Inches (mm)	1.00 (25.4)	0.81 (20.6)	0.81 (20.6)	0.94 (23.9)	0.94 (23.9)	0.94 (23.9)	0.94 (23.9)
Bolt Hole Diameter (E)* Inches (mm)	0.33 (8.38)	0.33 (8.38)	0.33 (8.38)	0.33 (8.38)	0.33 (8.38)	0.33 (8.38)	0.33 (8.38)
No. of Bolt Holes (F)	8	16	16	16	16	20	24
Bolt Circle Diameter (G) Inches (mm)	3.628 (92.2)	5.128 (130.3)	5.128 (130.3)	5.128 (130.3)	5.128 (130.3)	7.128 (181.1)	9.128 (132)
Bolt Hole Offset Angle (H)	22° 30'	11° 15'	11° 15'	11° 15'	11° 15'	9°	7° 30'
Overall Height*** Inches (mm)	12.29 (312.2)	14.17 (360)	14.17 (360)	14.17 (360)	14.17 (360)	15.67 (398)	17.99 (456.9)
<p>*Refer to Figure 7, page 26.</p> <p>**Where Viton is used, other materials are available; consult factory.</p>							

JIS Flange Specifications

Valve Type Number	153B-2-50J-1	153B 2-50J-2	153B 4-100J-2
Inside Diameter (A)* Inches (mm)	1.888 (48.0)	2.000 (50.8)	3.875 (98.4)
Mounting Flange	JIS 50 mm	JIS 50 mm	JIS 100 mm
Outside Diameter (B)* Inches (mm)	4.47 (113.5)	4.47 (113.5)	7.40 (188.0)
Controllable Conductance (l/sec) min max	0.35 300	0.70 300	1.50 900
Closed Leakage (Torr l/sec)	$<10^{-7}$	N/A	N/A
Flapper Seal**	Viton	None	None
Thickness (D)* Inches (mm)	1.00 (25.4)	1.00 (25.4)	0.94 (23.9)
Bolt Hole Diameter (E)* Inches (mm)	0.39 (9.91)	0.39 (9.91)	0.47 (11.9)
No. of Bolt Holes (F)	4	4	8
Bolt Circle Diameter (G) Inches (mm)	3.937 (100)	3.937 (100)	6.299 (160)
Bolt Hole Offset Angle (H)	45°	45°	22.5°
Flange O-ring Groove ID (J) In (mm) Parker® No. or Size (JIS)	2.766 (70.26) 2.756 x 0.157 (70) x (4)	2.766 (70.26) 2.756 x 0.157 (70) x (4)	4.724 (120) 4.724 x 0.157 (120) x (4)
Overall Height Inches (mm)	12.29 (312.2)	12.29 (312.2)	15.22 (386.6)
<p><i>*Refer to Figure 8, page 27.</i></p> <p><i>**Where Viton is used, other materials are available; consult factory.</i></p>			

Due to continuing research and development activities, these product specifications are subject to change without notice.

Appendix B: Model Code Explanation

Model Code

The options for your 153 controller are identified in the model code when you order the unit. The model code is identified as follows:

153E X Y Z

where:

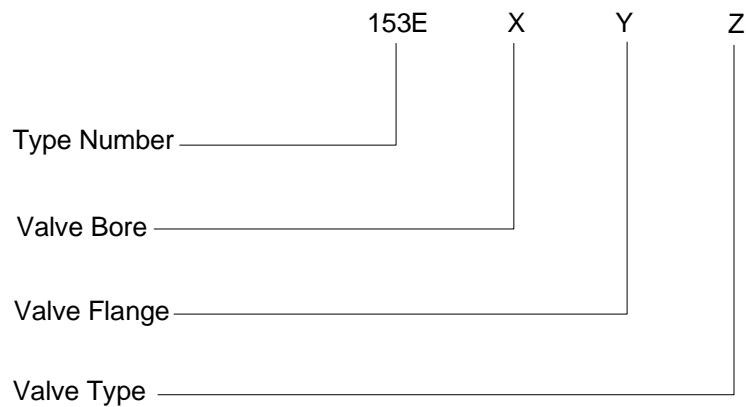

Note



Complete model codes for various configurations of the 153 controller are listed in Tables 19 to 22, pages 97 to 100.

Type Number (153E)

The type number designates the model number of the instrument.

Valve Bore (X)

The valve bore (the internal valve diameter) in millimeters (mm) or inches (in) is indicated by a one or two digit code. The valve bore is listed in column 2 in Tables 19 to 22, pages 97 to 100.

Valve Flange (Y)

The type of flange is designated by a one to four character code. The valve flange is listed in column 3 in Tables 19 to 22, pages 97 to 100.

Valve Type (Z)

The type of valve (sealing or non-sealing) is designated by a single number code. The valve type is listed in column 4 in Tables 19 to 22, pages 97 to 100.

Valve Type**Ordering Code**

Sealing

1

Non-sealing

2

Type 153 Controller Model Codes

Type 153 Units with ASA Flanges

Model Codes for Type 153 Units with ASA Flanges			
Model Code	Valve Bore (Nominal Inside Diameter) inches (mm)	ASA Flange Size	Flapper O-Ring
153E-2-2-1	1.88 (47.8)	2"	Yes
153E-2-2-2	1.950 (49.5)	2"	No
153E-60-2-2	2.362 (60.0)	2"	No
153E-3-2-1	2.888 (73.4)	2"	No
153E-3-2-2	3.025 (76.8)	2"	No
153E-3-3-1	3.025 (76.8)	3"	No
153E-3-3-2	3.025 (76.8)	3"	No
153E-4-3-1	3.888 (98.8)	3"	No
153E-4-3-2	3.965 (100.7)	3"	No
153E-4-4-1	3.888 (98.8)	4"	No
153E-4-4-2	3.965 (100.7)	4"	No
153E-6-4-2	5.781 (146.8)	4"	No
153E-6-6-2	5.781 (146.8)	6"	No
153E-8-6-2	7.501 (190.5)	6"	No
153E-8-8-2	7.501 (190.5)	8"	No
153E-10-10-2	10.000 (254.0)	10"	No

Table 19: Model Codes for Type 153 Units with ASA Flanges

Type 153 Controller with KF or NW ISO Flanges

Model Codes for Type 153 Units with KF or NW ISO Flanges			
Model Codes	Valve Bore (Nominal Inside Diameter) inches (mm)	ISO Flange Size	Flapper O-Ring
153E-20-40-1*	0.779 (19.8)	KF-40	Yes
153E-20-40-2*	0.779 (19.8)	KF-40	No
153E-1-40-1*	1.270 (32.3)	KF-40	Yes
153E-1-40-2*	1.270 (32.3)	KF-40	No
153E-2-50-1*	1.888 (48.0)	KF-50	Yes
153E-2-50-2*	2.000 (50.8)	KF-50	No
153E-60-63-2	2.362 (60.0)	NW-63	No
153E-3-80-1	2.888 (73.4)	NW-80	No
153E-3-80-2	3.000 (76.2)	NW-80	No
153E-4-100-1	3.888 (98.8)	NW-100	No
153E-4-100-2	3.875 (98.4)	NW-100	No
153E-6-160-2	5.750 (146.1)	NW-160	No
153E-8-200-2	7.650 (194.3)	NW-200	No
153E-10-250-2	9.700 (246.4)	NW-250	No
<i>* Available with optional heater; consult factory for more information.</i>			

Table 20: Model Codes for Type 153 Units with KF or NW ISO Flanges

Type 153 Controller with CF Flanges

Model Codes for Type 153 Units with CF Flanges			
Model Code	Valve Bore (Nominal Inside Diameter) inches (mm)	CF Flange Size	Flapper O-Ring
153E-20-2CF-1	0.779 (19.79)	2¾"	Yes
153E-20-2CF-2	0.779 (19.79)	2¾"	No
153E-1-2CF-1	1.270 (32.3)	2¾"	Yes
153E-1-2CF-2	1.270 (32.3)	2¾"	No
153E-2-3CF-1	1.888 (48.0)	3⅜"	Yes
153E-2-3CF-2	2.000 (50.8)	3⅜"	No
153E-2-4CF-1	1.888 (48.0)	4½"	Yes
153E-2-4CF-2	2.000 (50.8)	4½"	No
153E-3-6CF-1	2.888 (73.4)	6"	No
153E-3-6CF-2	3.000 (76.2)	6"	No
153E-4-6CF-1	3.888 (98.8)	6"	No
153E-4-6CF-2	3.875 (98.4)	6"	No
153E-2-8CF-1	5.750 (146.1)	8"	
153E-2-8CF-2	7.650 (194.3)	10"	

Table 21: Model Codes for Type 153 Units with CF Flanges

Type 153 Controller with JIS Flanges

Model Codes for Type 153 Units with JIS Flanges			
Model Code	Valve Bore (Nominal Inside Diameter) inches (mm)	JIS Flange Size	Flapper O-Ring
153E-2-50J-1	1.888 (48.0)	JIS-50	Yes
153E-2-50J-2	2.000 (50.8)	JIS-50	No
153E-4-100J-2	3.875 (98.4)	JIS-100	No

Table 22: Model Codes for Type 153 Units with CF Flanges

Portable RS-232 Terminal Model Code

The hand-held RS-232 terminal used for setup and diagnostics is ordered separately and is identified as the Type PT-1A.

Index

A

- Absolute pressure, calculating, 72
- Analog set point
 - full scale, 64, 73
 - zero, 63
- ASA flanges, 24, 87–88, 97

B

- Baud rate, 46

C

- Cables
 - generic shielded, 21
 - interface, 20
 - null modem, 37
 - portable terminal, 36
- Calibration
 - adjusting for output error, 68–71
 - scaling voltage signals, 65, 66
 - system characteristics, 62–67
- CE Mark, 17, 20, 49, 85
- CF flanges, 26, 92–93, 99
- Commands, format of, 54
- Connectors, 85
 - Input connector J1, 33, 42
 - Power connector J2, 32, 42
- Control mode
 - description of, 39
 - selection of, 45
- Customer support, 18

D

- Dimensions, 23–27
- Dipswitch bank
 - changing settings, 47, 51
 - description of, 44
 - functions and settings, 44

E

- End-of-line delimiter, 46

F

- Full scale
 - analog set point, 64
 - pressure, 66

G

- Gain
 - command, 58
 - description of, 41
- Grounding, 28

H

- Heated valves, 30
- Hold/Normal switch, 43

I

- Initial settings
 - reset command, 80
 - RS-323 communication, 52
- Input connector J1, 33, 42

Introduction, 17

J

JIS flanges, 27, 94, 100

K

KF ISO flanges, 25, 89–90, 98

L

Labels, 49

Lead

adjusting, 78

command, 58

description of, 40

LEDs, 43, 85

power up sequence, 48

M

Maintenance, 83

Manual organization, 18

Manual valve switch, 43

Model code

description of, 95–96

examples of, 97–100

Mounting instructions, 30

heated valves, 30

system configuration, 30

N

Non-volatile memory, 48

Normal valve control, 46

Null modem cable, 37

NW ISO flanges, 26, 91, 98

O

Output signals, adjusting, 35

P

Parity, 46

Portable terminal

cable, 36

dipswitch settings, 53

Position control

calibrating zero and FS outputs, 70

description of, 39

Power connector J2, 32, 42

Power down constants, 48

Power requirements, 17, 28, 85

Power up, 48

Pressure

full scale, 66

reporting, 72

Pressure control

calibrating zero and FS outputs, 71

description of, 39

Pressure zero, 65

Pump label, 49

R

RAM, 48

Requests, format of, 54

Reset command, 80

Responses, format of, 54

Returning the product, 18, 19

Reverse valve control, 46

RS-232

calibration messages, 62–71

-
- commands, 56–73
 - communication parameters, 53
 - message protocol, 54
 - operating protocol, selection of, 46
 - operating value messages, 57–58
 - valve position messages, 59–61
- S**
- Safety information, 1–16, 51
 - Sealing/non-sealing valves, 28, 96
 - Serial number label, 49
 - Set point
 - commands, 58
 - control type, 45
 - format of, 46
 - signal source, 46
 - Specifications
 - flanges, 87–94
 - standard valve, 85
 - System configuration, 30
- T**
- Temperature, operating, 17, 85
 - Troubleshooting
 - reset command, 80
 - valve slipped signal, 73, 84
 - Tuning, 78–82
- V**
- Valve
 - action, 46
 - bore, 95
 - control direction, 46
 - flange, 95
 - position command, 60
 - steps, 67
 - type, 96
 - Valve safety, 51
 - Valve slipped signal, 73, 84
- Z**
- Zero
 - analog set point, 63
 - pressure, 65

